



US00D692659S

(12) **United States Design Patent**
Bloch

(10) **Patent No.:** **US D692,659 S**

(45) **Date of Patent:** **** Nov. 5, 2013**

(54) **CUTLERY CASE**

(71) Applicant: **Outdoor Edge Cutlery Corporation,**
Wheat Ridge, CO (US)

(72) Inventor: **David R. Bloch,** Morrison, CO (US)

(73) Assignee: **Outdoor Edge Cutlery Corporation,**
Wheat Ridge, CO (US)

(**) Term: **14 Years**

(21) Appl. No.: **29/451,273**

(22) Filed: **Mar. 29, 2013**

(51) **LOC (9) Cl.** **03-01**

(52) **U.S. Cl.**

USPC **D3/282; D7/637; D3/284; D3/903**

(58) **Field of Classification Search**

USPC **D7/637; 206/249, 372-379, 553;**
D3/272, 273, 276, 280, 281, 282,
D3/283-286, 293, 291, 294, 905, 903

See application file for complete search history.

(56) **References Cited**

U.S. PATENT DOCUMENTS

D400,010 S * 10/1998 Vasudeva D3/276
D422,787 S * 4/2000 Feng D3/273
6,105,767 A * 8/2000 Vasudeva 206/372

D434,562 S * 12/2000 Huang D3/282
D483,945 S * 12/2003 Tanji D3/302
D499,549 S * 12/2004 Rosler D3/282
D502,598 S * 3/2005 Chen D3/273
D502,808 S * 3/2005 Hepworth et al. D3/276
D599,549 S * 9/2009 Moss et al. D3/282
D668,866 S * 10/2012 Meng D3/273

* cited by examiner

Primary Examiner — Jennifer Rivard

(74) *Attorney, Agent, or Firm* — Sheridan Ross, PC

(57) **CLAIM**

The ornamental design for a cutlery case, as shown and described.

DESCRIPTION

FIG. 1 is a perspective view of the cutlery case;
FIG. 2 is a top plan view thereof;
FIG. 3 is a front elevation view thereof;
FIG. 4 is a right elevation view thereof;
FIG. 5 is a left elevation view thereof;
FIG. 6 is a rear elevation view thereof;
FIG. 7 is a bottom plan view thereof; and,
FIG. 8 is a perspective view of the cutlery case shown in an open position of use.

1 Claim, 4 Drawing Sheets

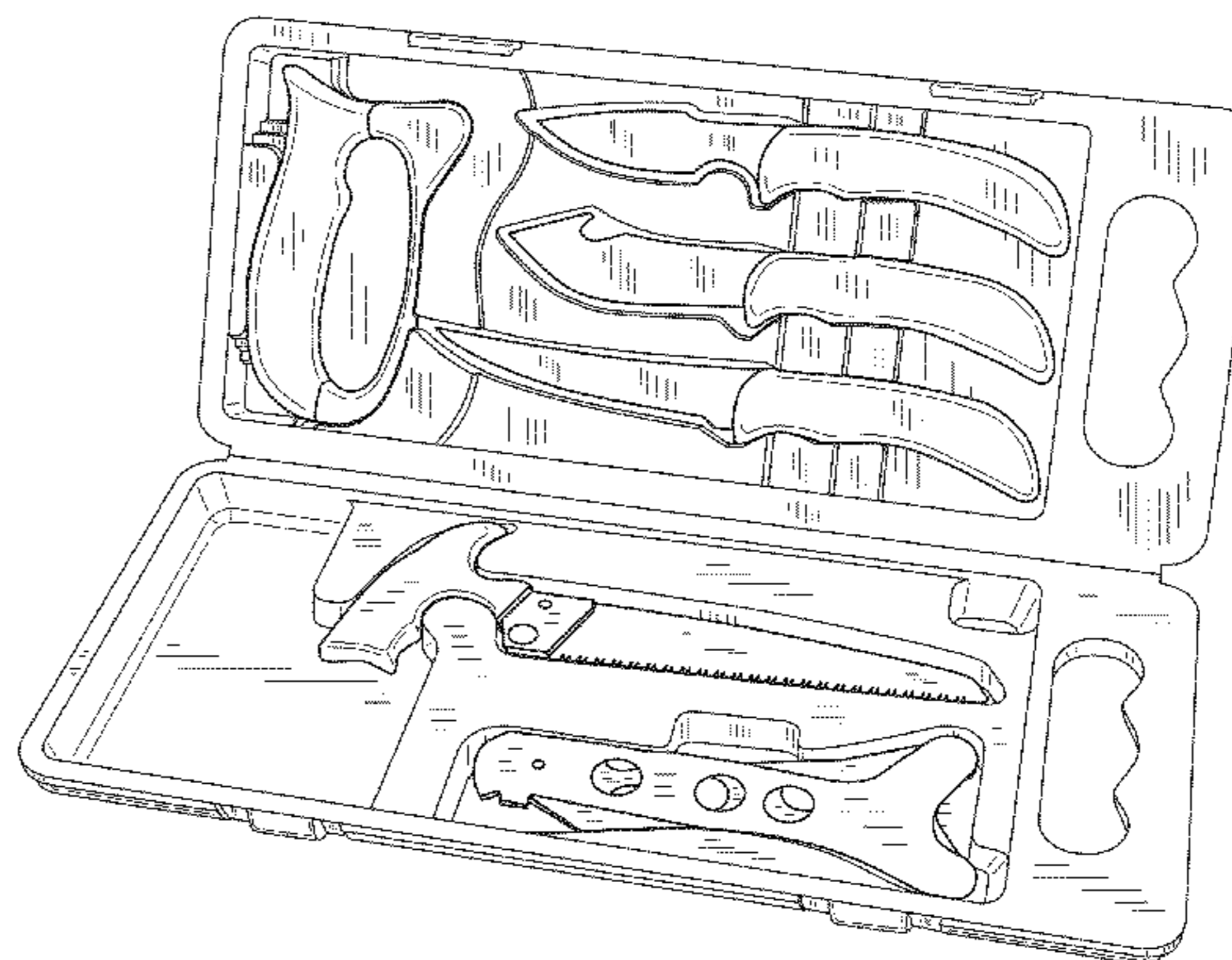
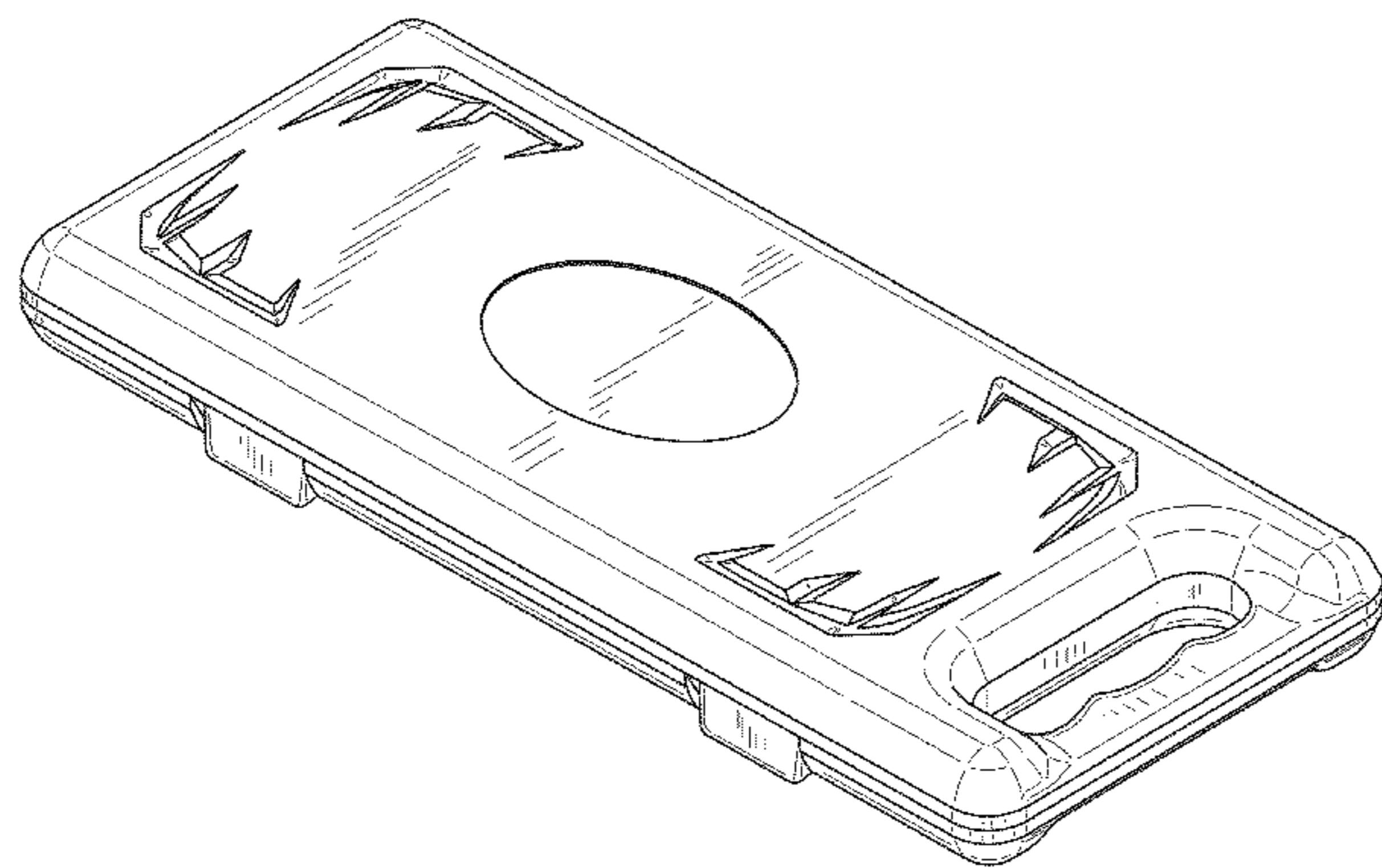

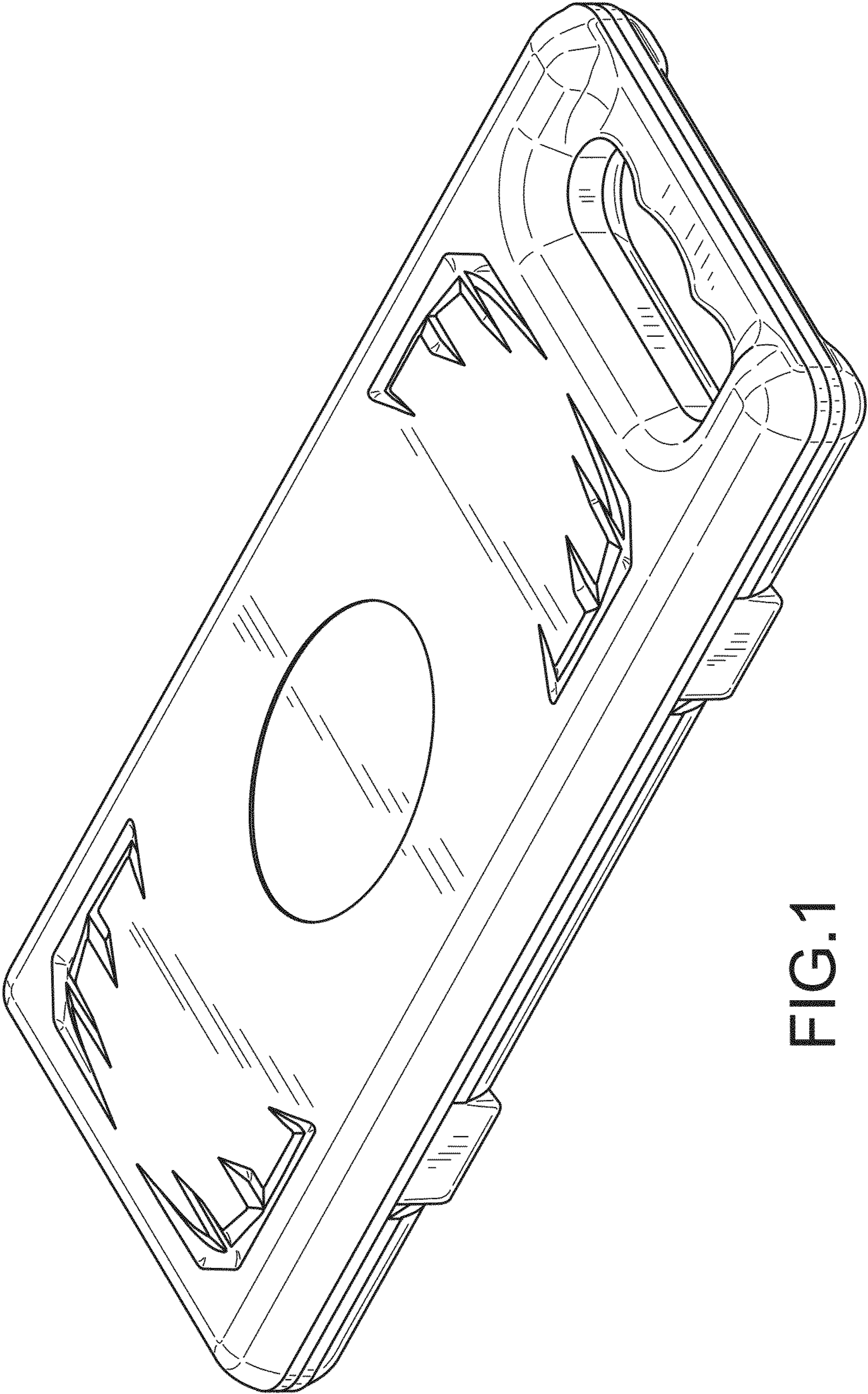

FIG.1

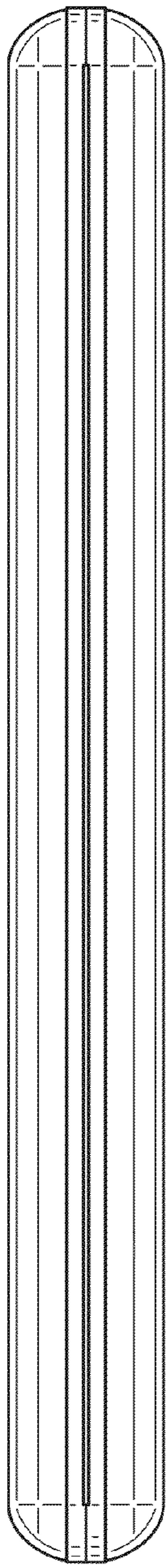

FIG. 2



FIG. 4

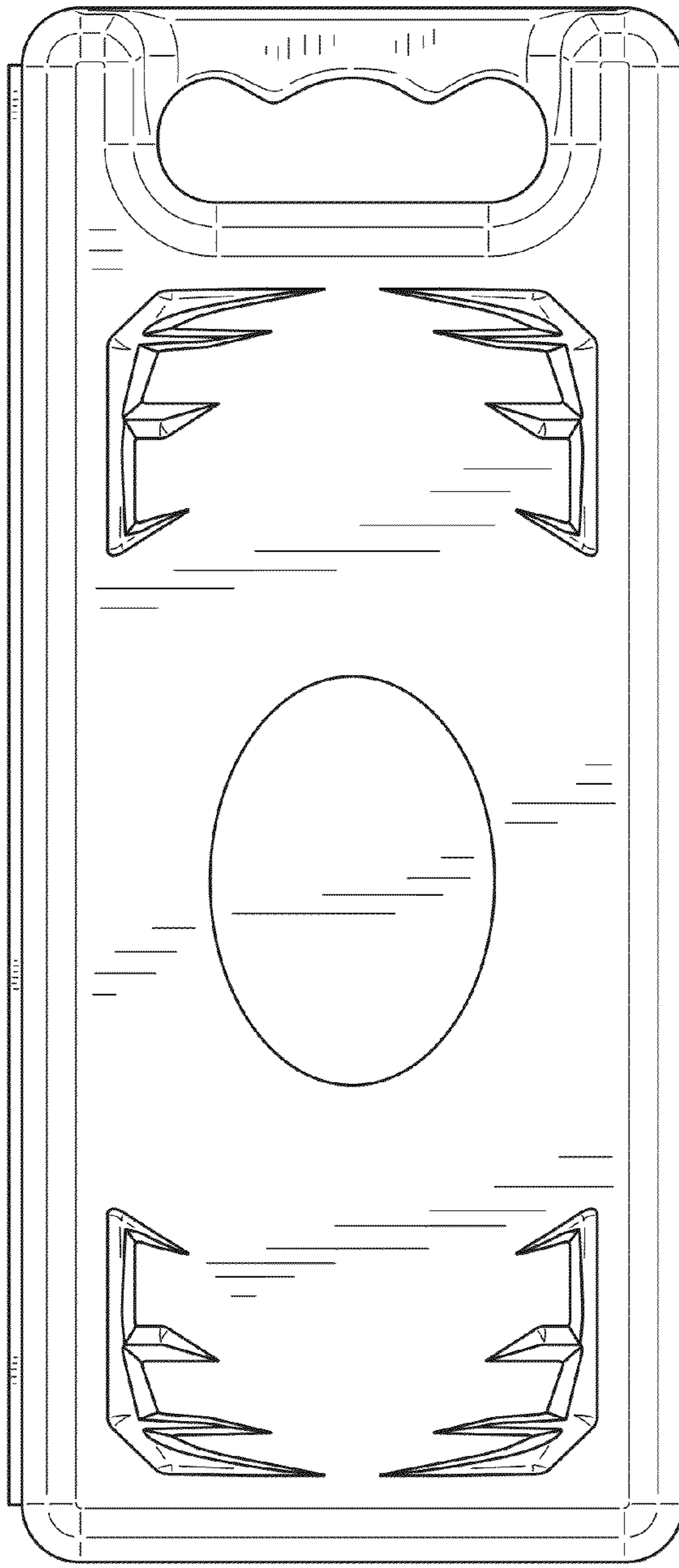

FIG. 3

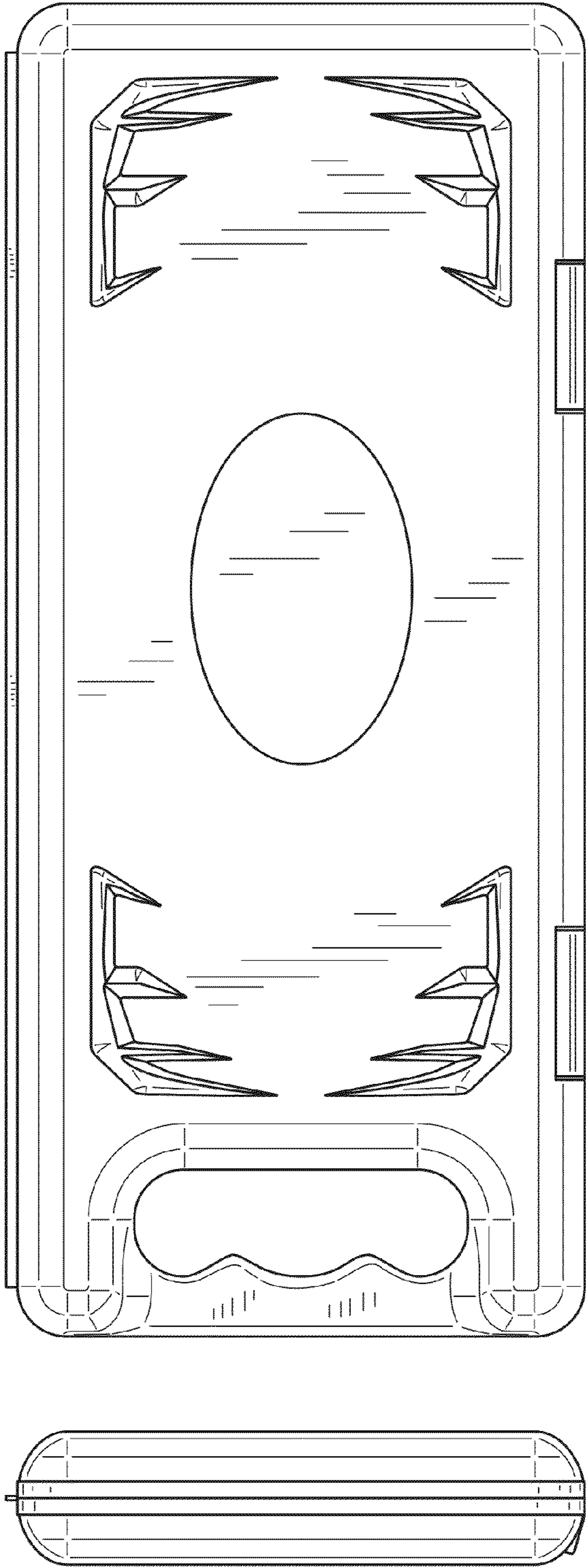

FIG. 5

FIG. 6

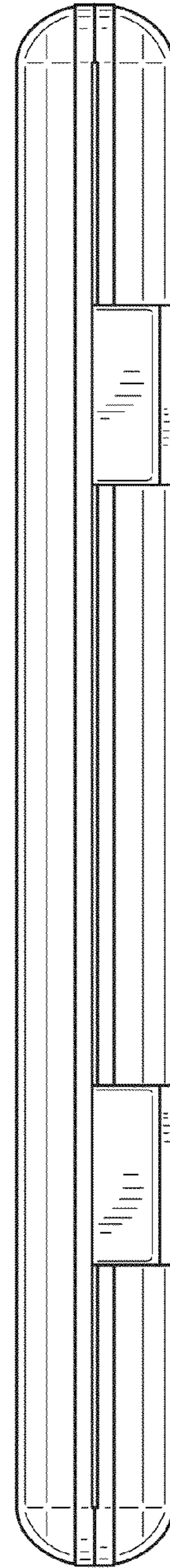

FIG. 7

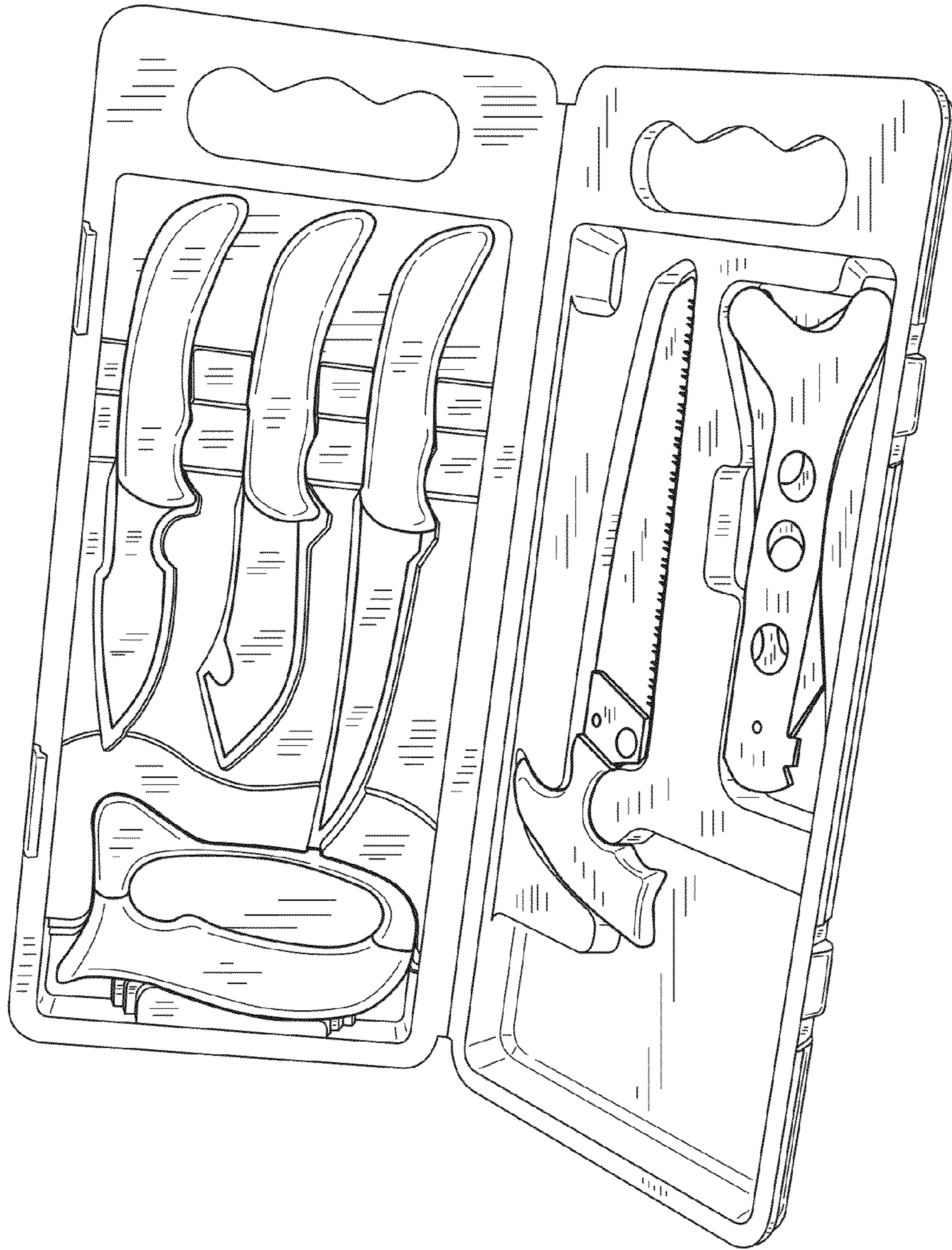

FIG.8