

US00D692657S

(12) **United States Design Patent**
Hyma et al.

(10) **Patent No.:** **US D692,657 S**
(45) **Date of Patent:** **** Nov. 5, 2013**

(54) **UTILITY KNIFE BLADE CASE**

DESCRIPTION

- (71) Applicant: **Milwaukee Electric Tool Corporation**,
Brookfield, WI (US)
- (72) Inventors: **Steven W. Hyma**, Milwaukee, WI (US);
Scott R. Fischer, Menomonee Falls, WI (US)
- (73) Assignee: **Milwaukee Electric Tool Corporation**,
Brookfield, WI (US)
- (**) Term: **14 Years**
- (21) Appl. No.: **29/433,513**
- (22) Filed: **Oct. 1, 2012**
- (51) **LOC (9) Cl.** **03-01**
- (52) **U.S. Cl.**
USPC **D3/273; D3/220**
- (58) **Field of Classification Search**
USPC **D3/273, 272, 276, 280-282, 201, 905,**
D3/220; 206/363, 372-379; 224/232;
D8/65
See application file for complete search history.

(56) **References Cited**

U.S. PATENT DOCUMENTS

3,381,807	A *	5/1968	De Vaughn	206/363
D502,598	S *	3/2005	Chen	D3/273
D524,046	S *	7/2006	Pangerc et al.	D3/273
D553,857	S *	10/2007	Pendergraph et al.	D3/273

* cited by examiner

Primary Examiner — Catheri Oliver-Garcia

(74) *Attorney, Agent, or Firm* — Michael Best & Friedrich LLP

(57) **CLAIM**

We claim the ornamental design for a utility knife blade case, as shown and described.

FIG. 1 is a perspective view of a utility knife blade case according to an embodiment of the invention.
 FIG. 2 is a front view of the case shown in FIG. 1.
 FIG. 3 is a rear view of the case shown in FIG. 1.
 FIG. 4 is a top view of the case shown in FIG. 1.
 FIG. 5 is a bottom view of the case shown in FIG. 1.
 FIG. 6 is a left side view of the case shown in FIG. 1.
 FIG. 7 is a right side view of the case shown in FIG. 1.
 FIG. 8 is a perspective view of a utility knife blade case according to an embodiment of the invention.
 FIG. 9 is a front view of the case shown in FIG. 8.
 FIG. 10 is a rear view of the case shown in FIG. 8.
 FIG. 11 is a top view of the case shown in FIG. 8.
 FIG. 12 is a bottom view of the case shown in FIG. 8.
 FIG. 13 is a left side view of the case shown in FIG. 8.
 FIG. 14 is a right side view of the case shown in FIG. 8.
 FIG. 15 is a perspective view of a utility knife blade case according to an embodiment of the invention.
 FIG. 16 is a front view of the case shown in FIG. 15.
 FIG. 17 is a rear view of the case shown in FIG. 15.
 FIG. 18 is a top view of the case shown in FIG. 15.
 FIG. 19 is a bottom view of the case shown in FIG. 15.
 FIG. 20 is a left side view of the case shown in FIG. 15.
 FIG. 21 is a right side view of the case shown in FIG. 15.
 FIG. 22 is a perspective view of a utility knife blade case according to an embodiment of the invention.
 FIG. 23 is a front view of the case shown in FIG. 22.
 FIG. 24 is a rear view of the case shown in FIG. 22.
 FIG. 25 is a top view of the case shown in FIG. 22.
 FIG. 26 is a bottom view of the case shown in FIG. 22.
 FIG. 27 is a left side view of the case shown in FIG. 22.
 FIG. 28 is a right side view of the case shown in FIG. 22.
 FIG. 29 is a perspective view of a utility knife blade case according to an embodiment of the invention.
 FIG. 30 is a front view of the case shown in FIG. 29.
 FIG. 31 is a rear view of the case shown in FIG. 29.
 FIG. 32 is a top view of the case shown in FIG. 29.
 FIG. 33 is a bottom view of the case shown in FIG. 29.
 FIG. 34 is a left side view of the case shown in FIG. 29; and,
 FIG. 35 is a right side view of the case shown in FIG. 29.

1 Claim, 18 Drawing Sheets

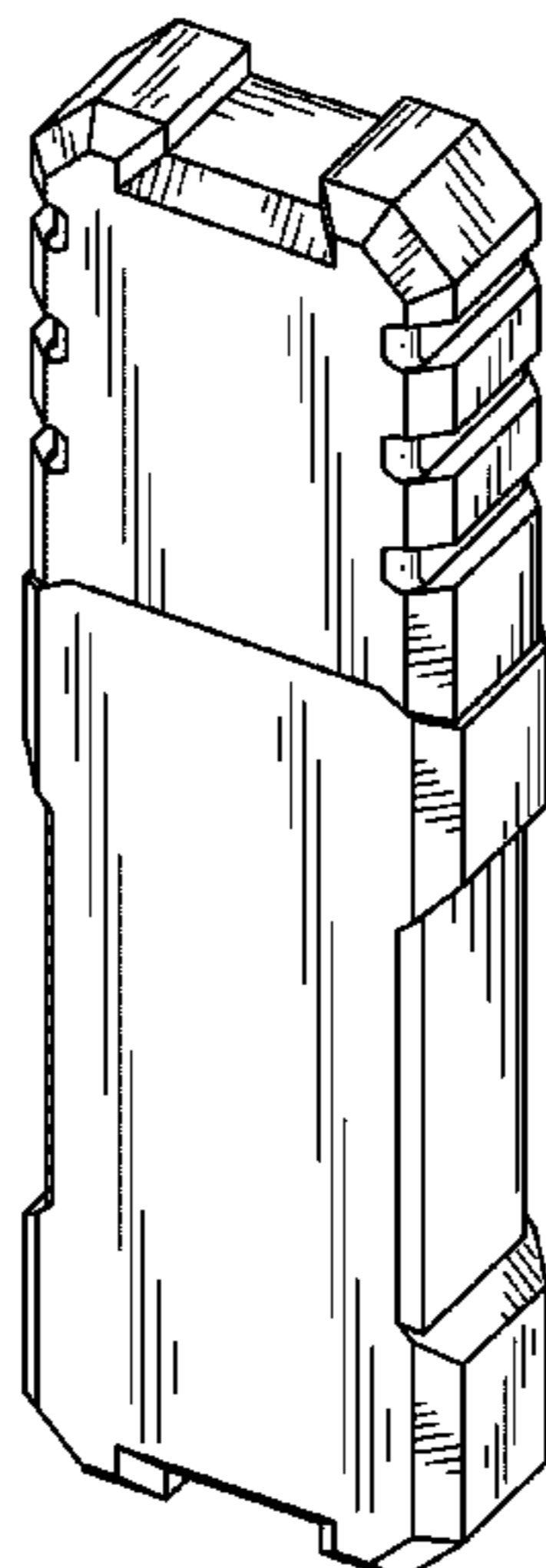

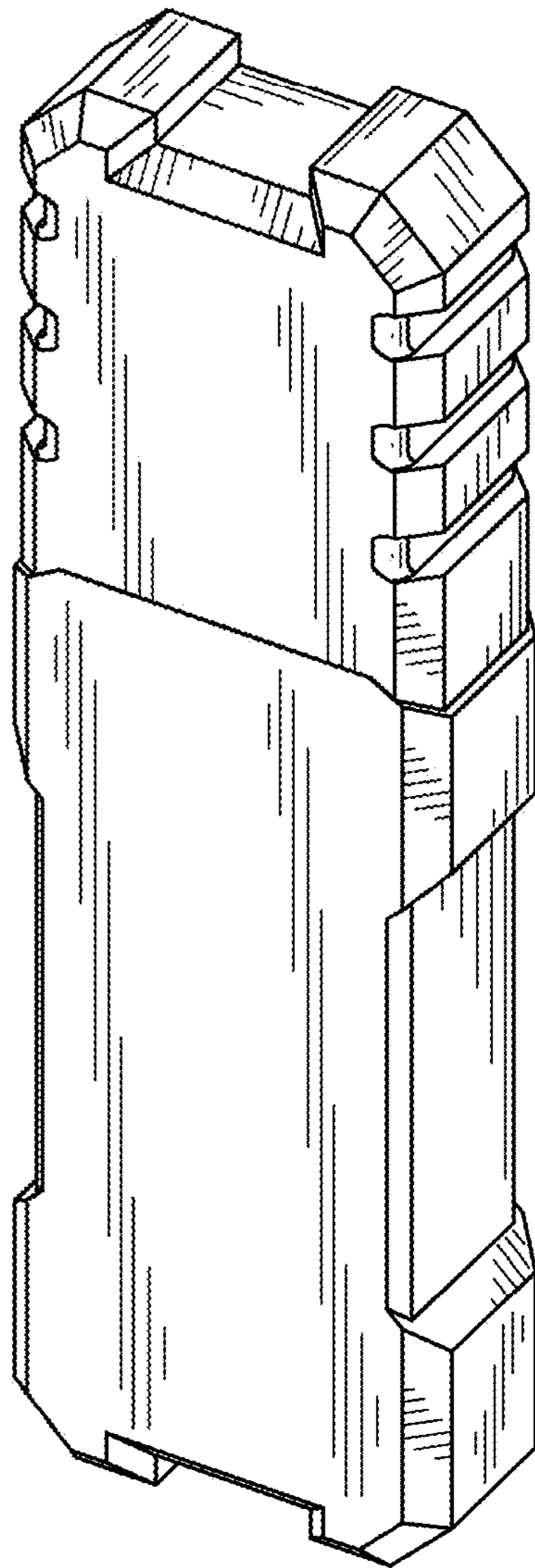

FIG. 1

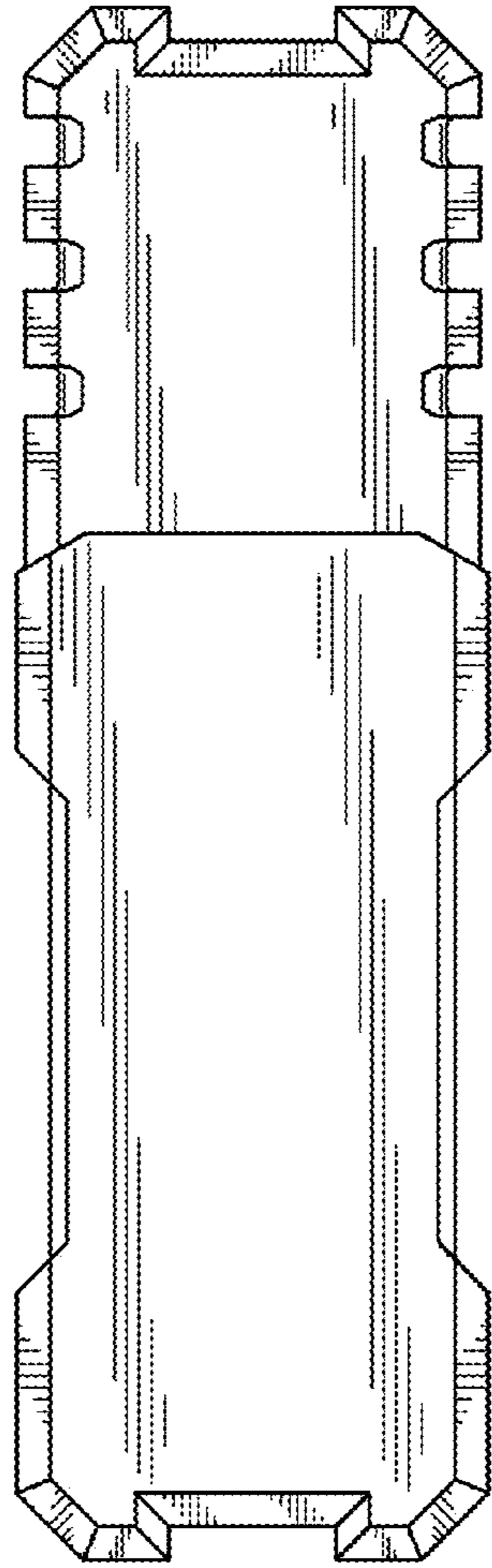

FIG. 2

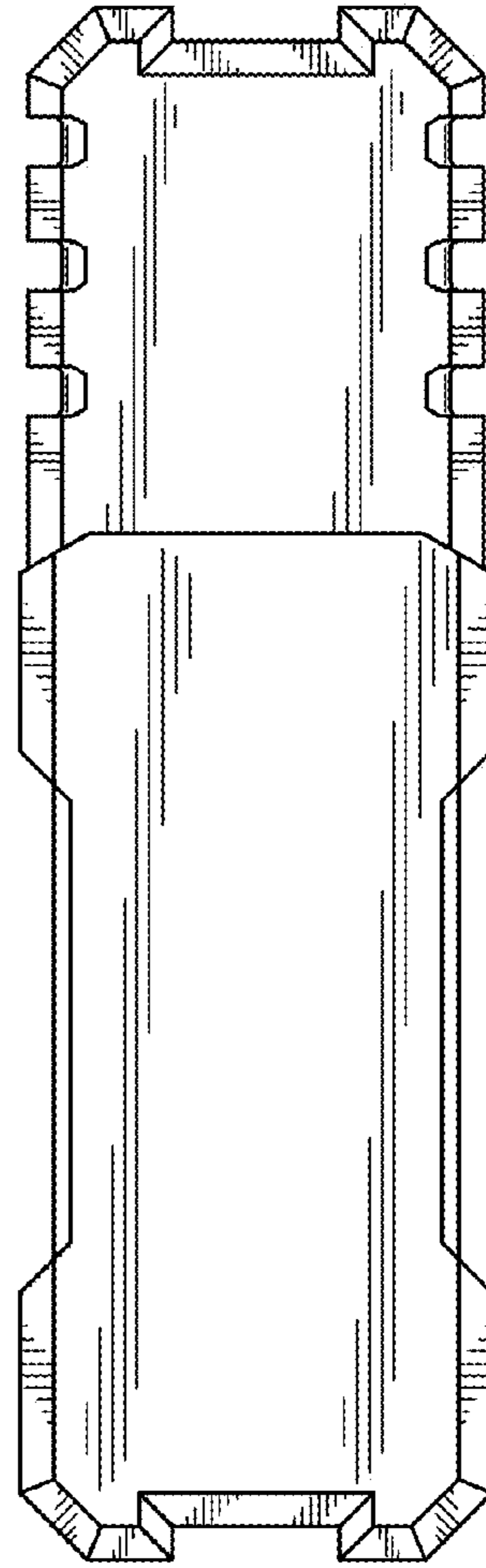

FIG. 3

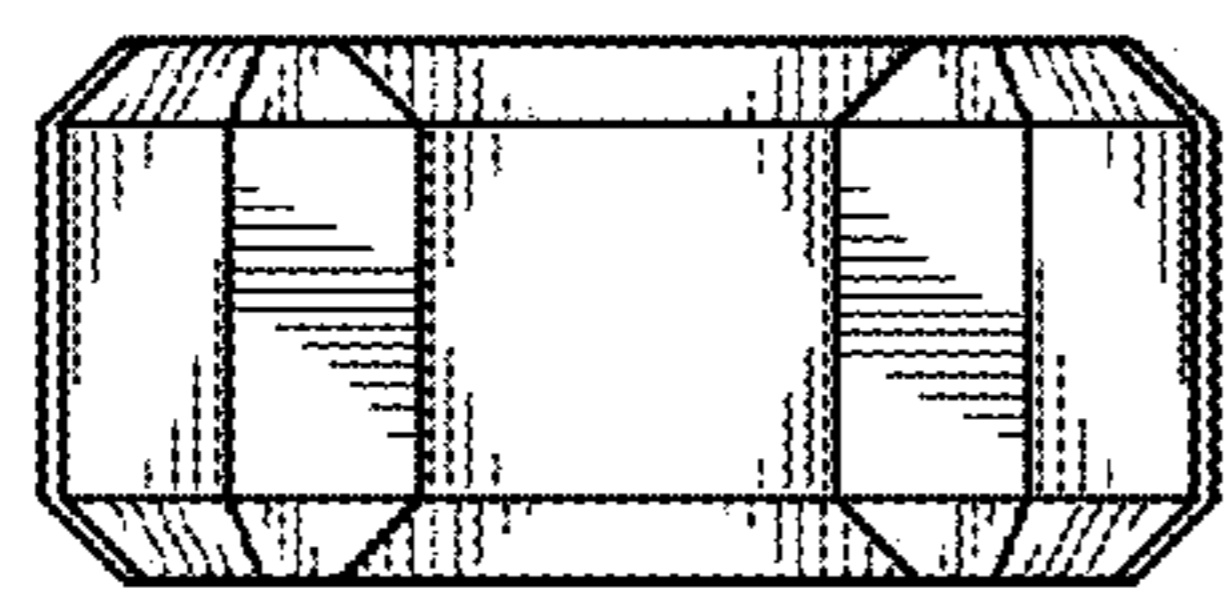

FIG. 4

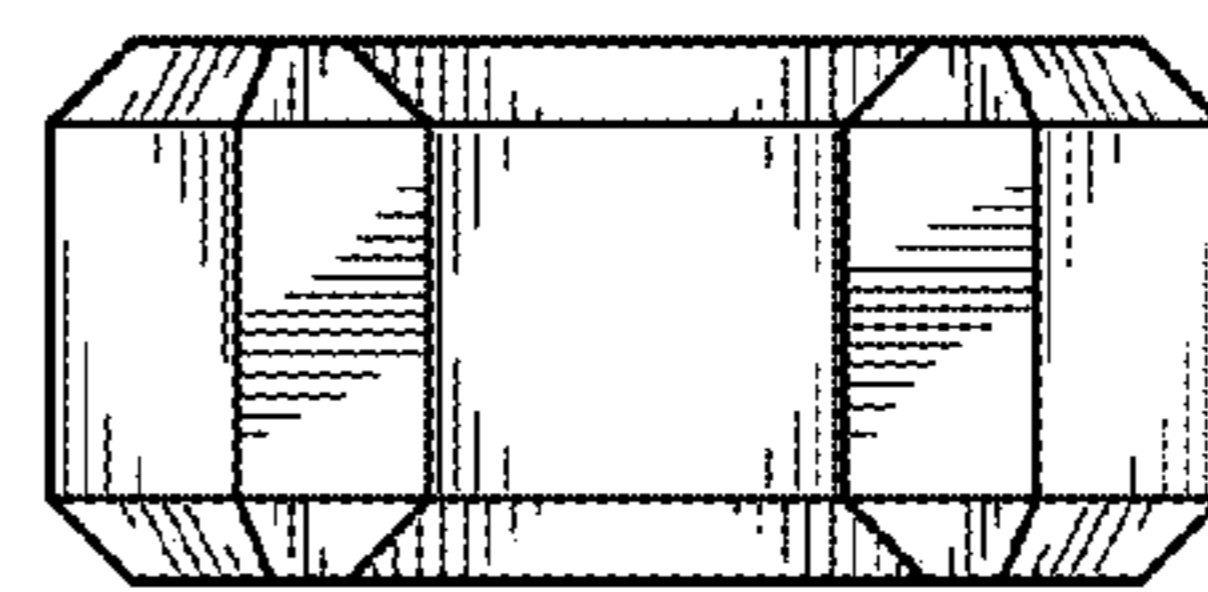

FIG. 5

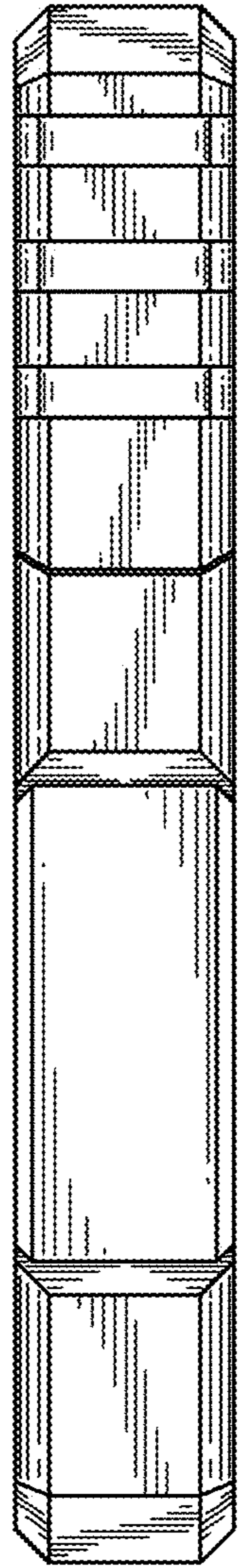

FIG. 6

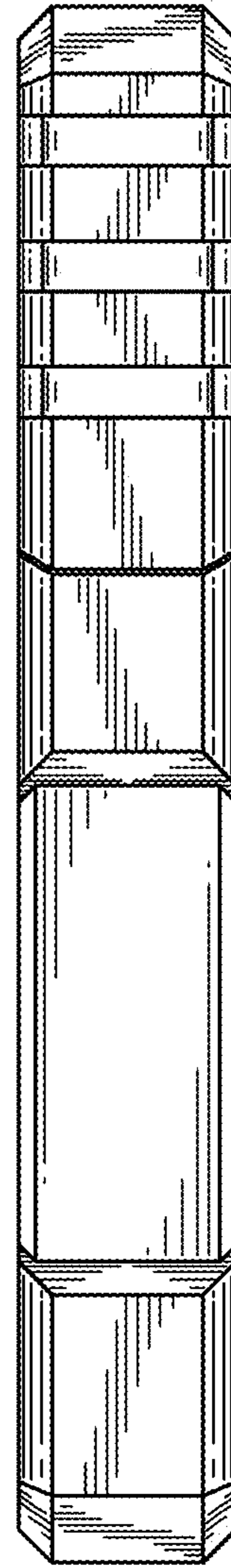

FIG. 7

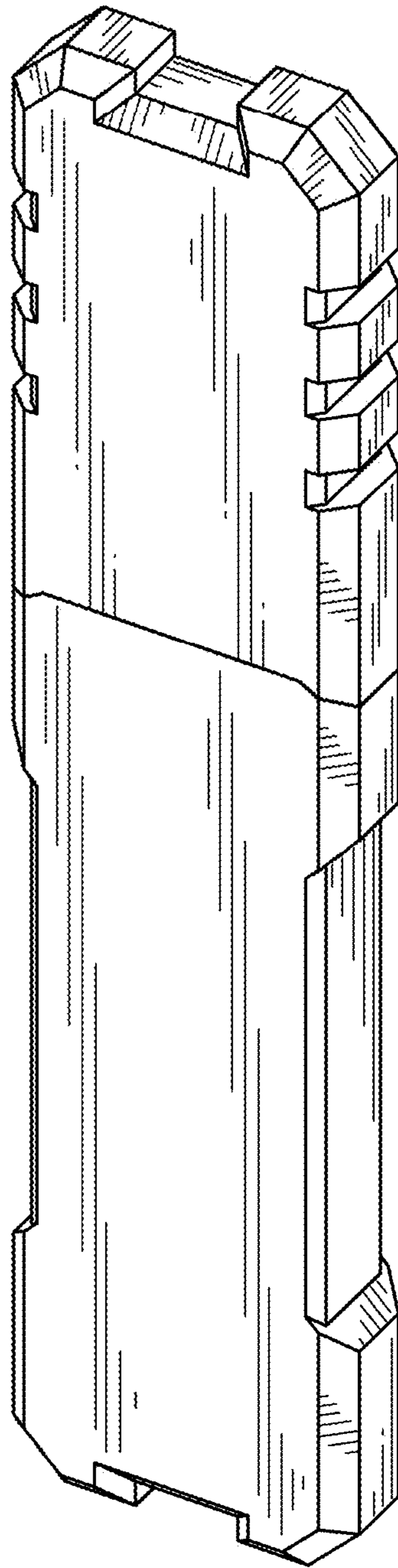

FIG. 8

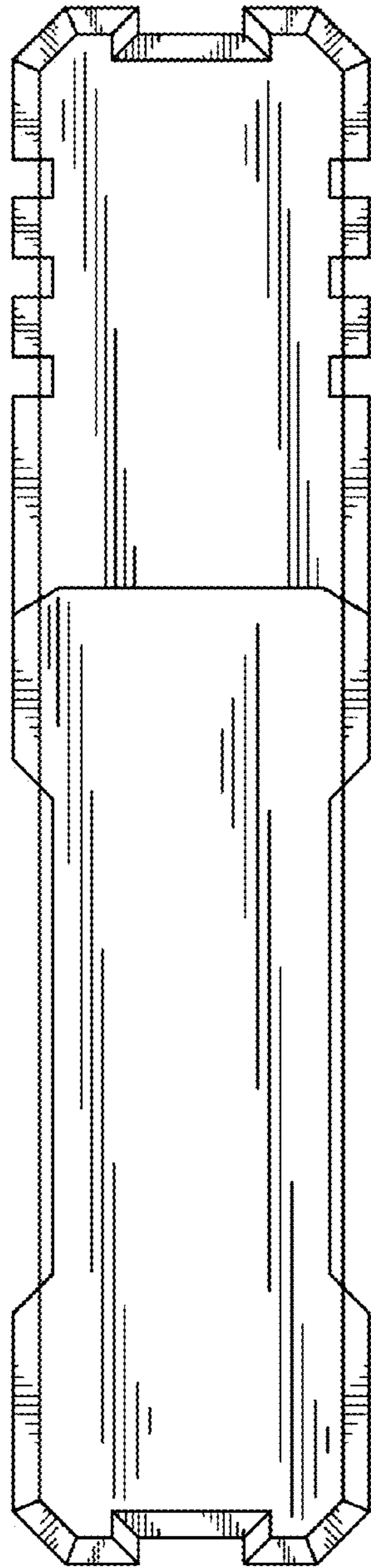

FIG. 9

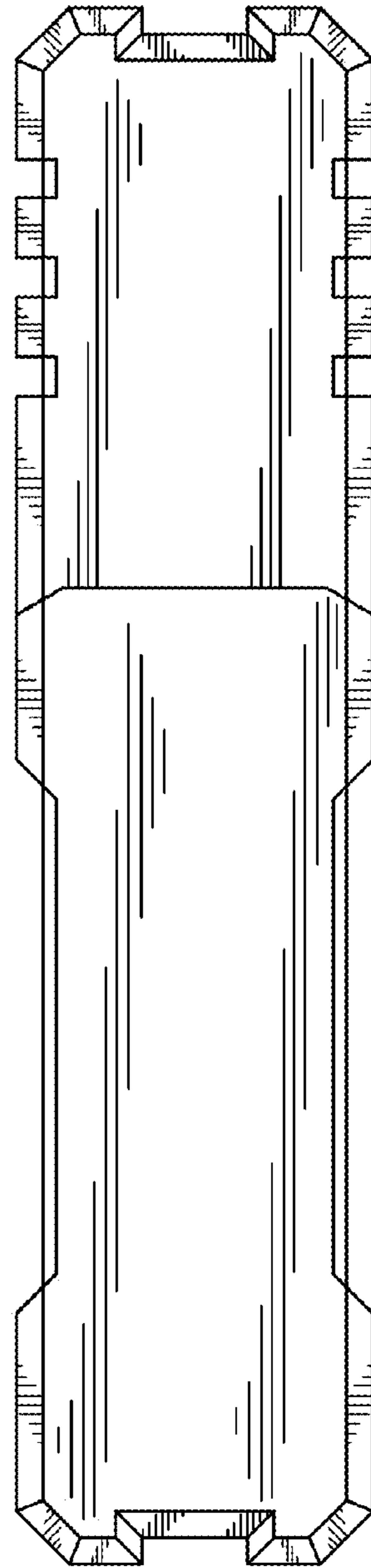

FIG. 10

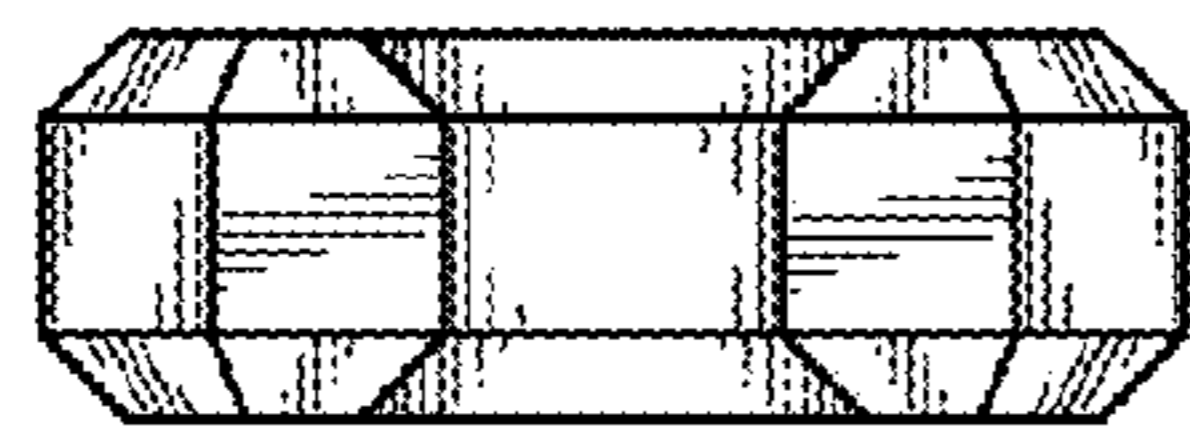

FIG. 11

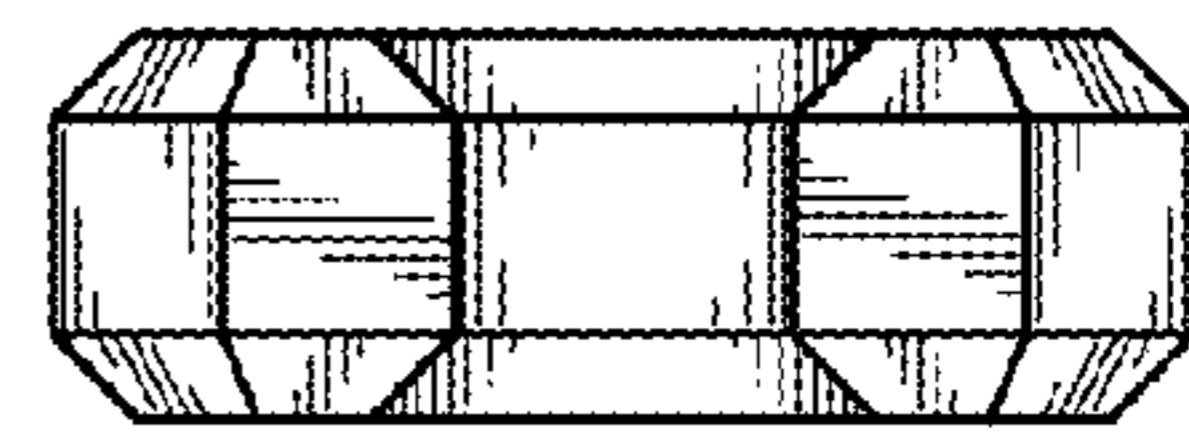

FIG. 12

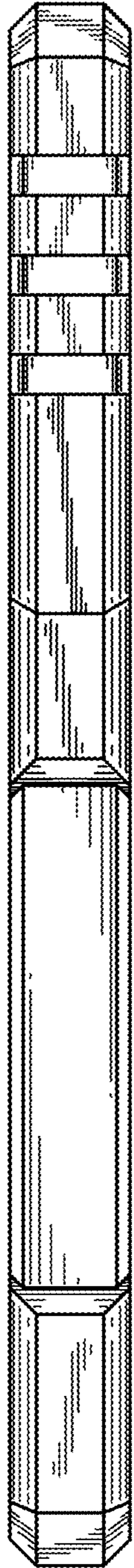

FIG. 13

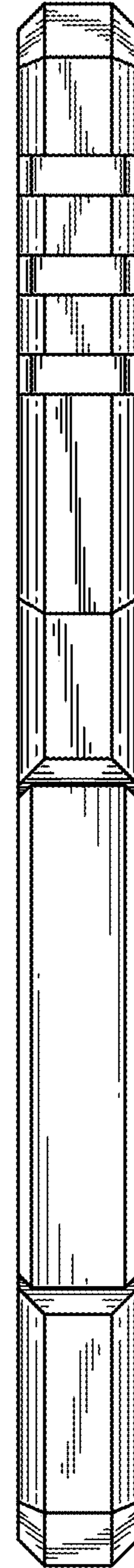

FIG. 14

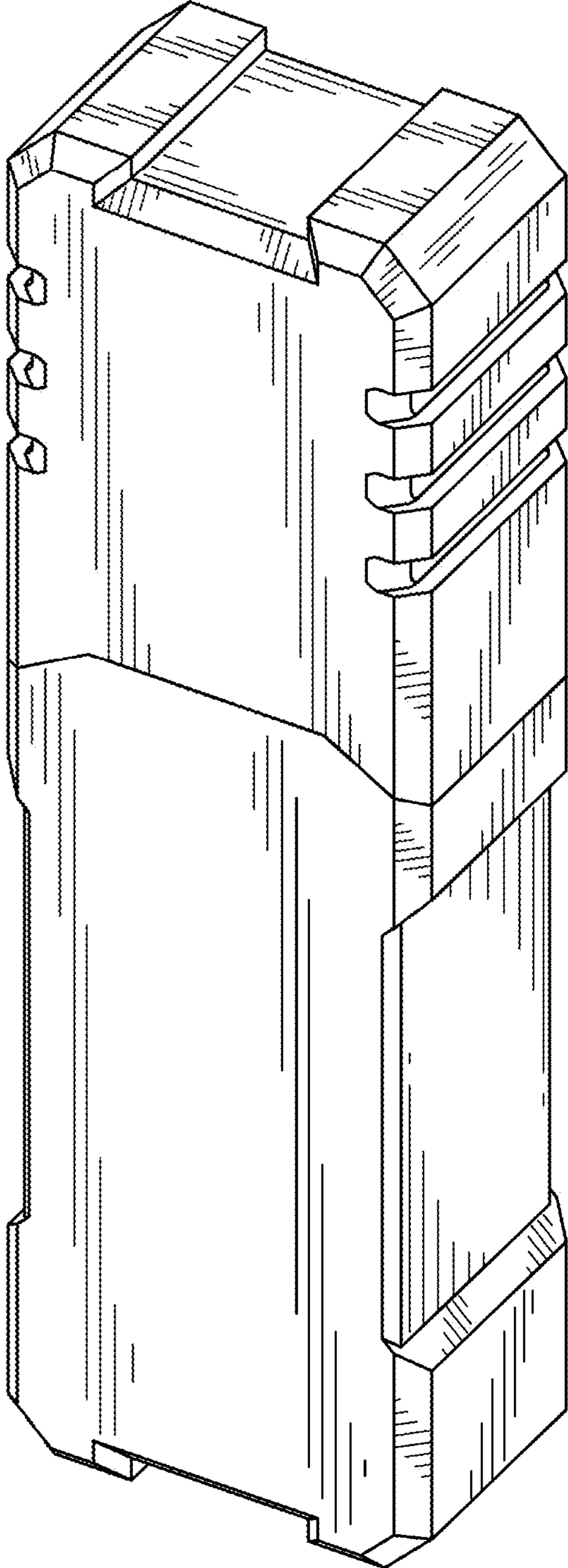

FIG. 15

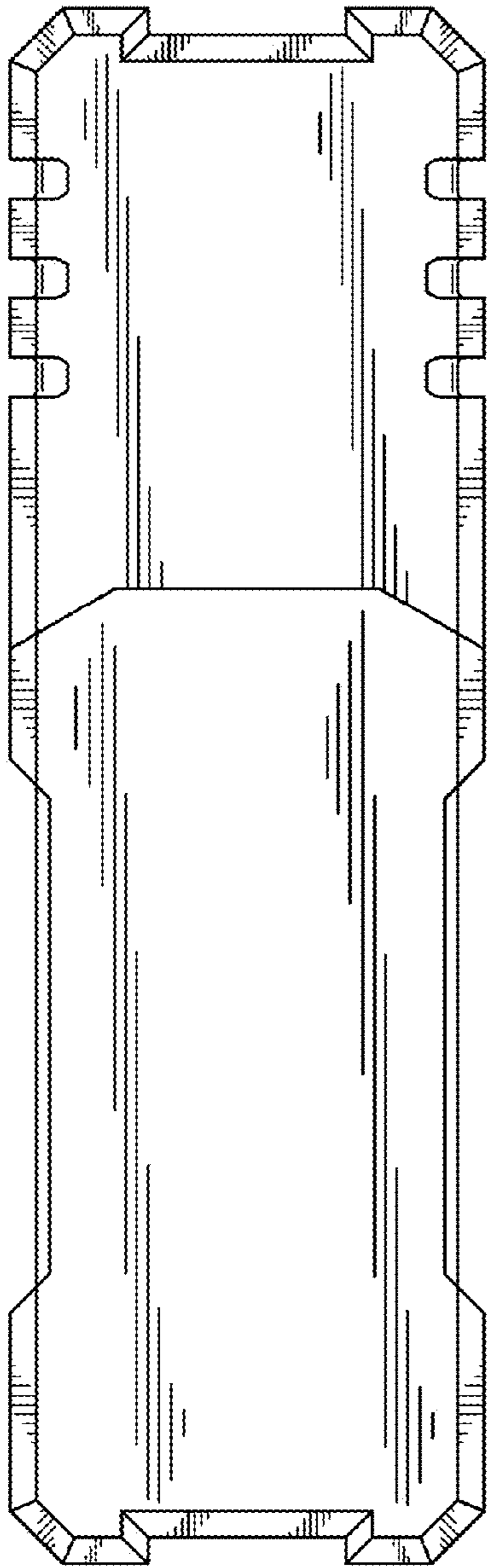

FIG. 16

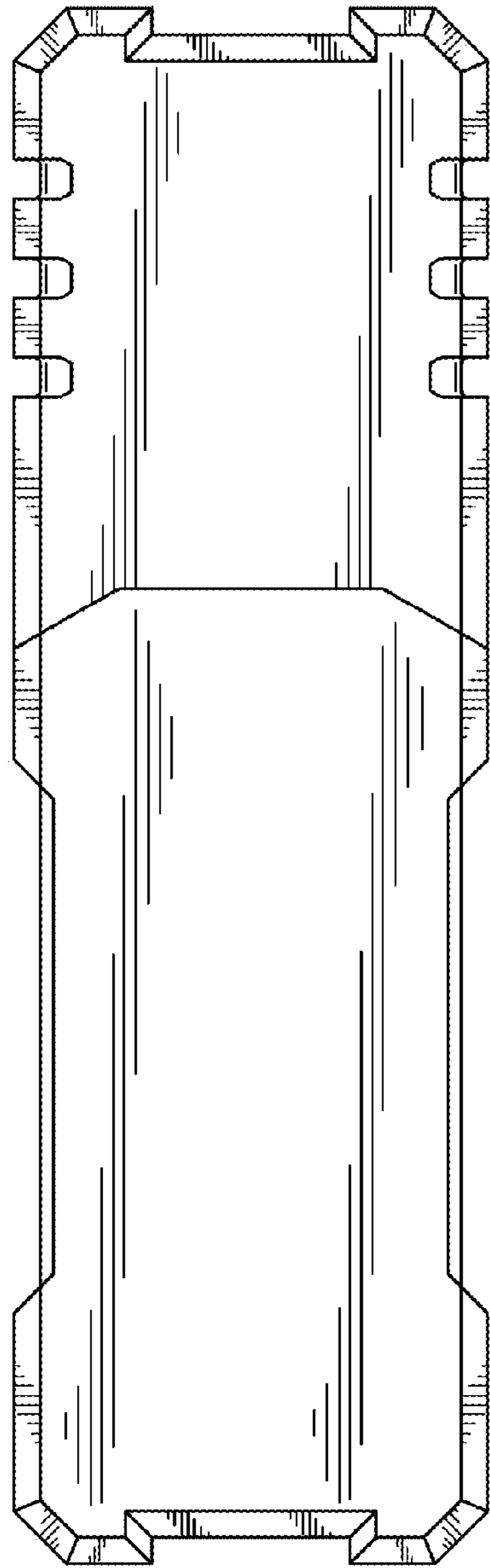

FIG. 17

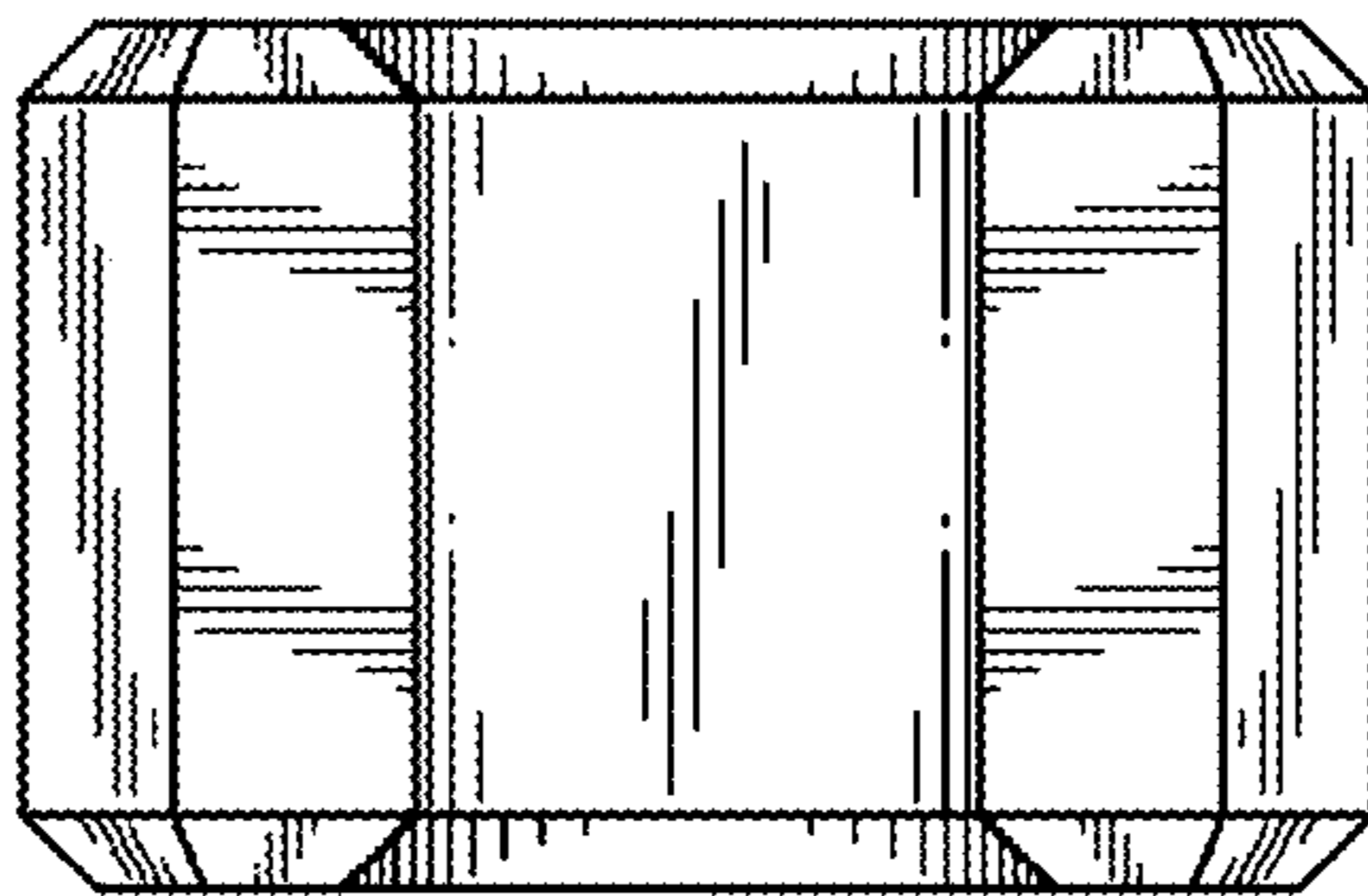

FIG. 18

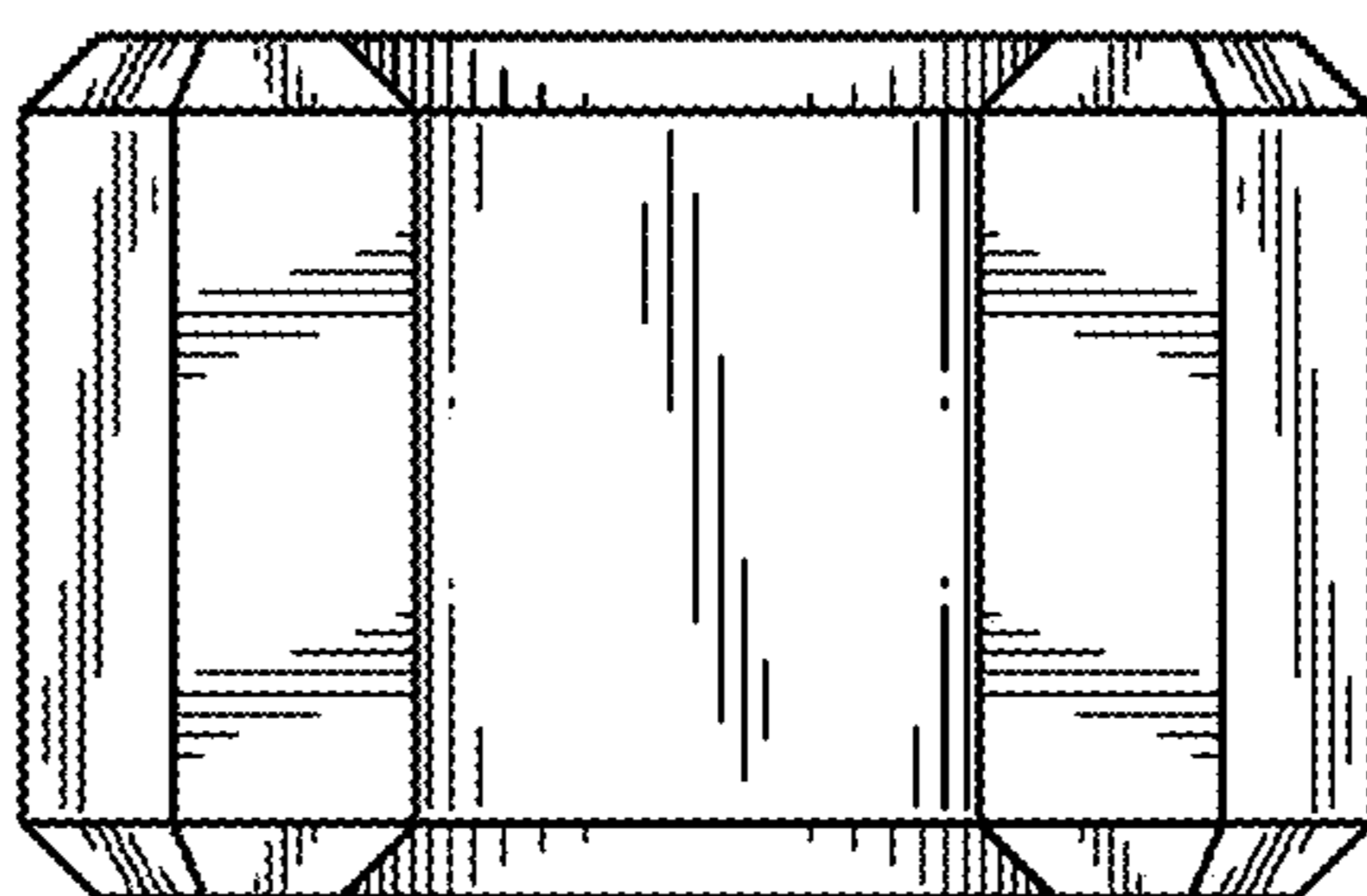

FIG. 19

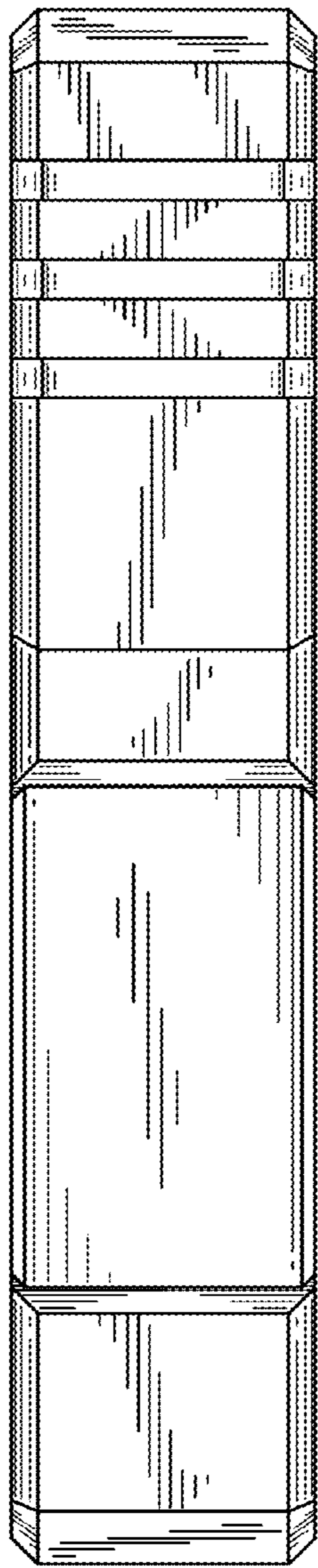

FIG. 20

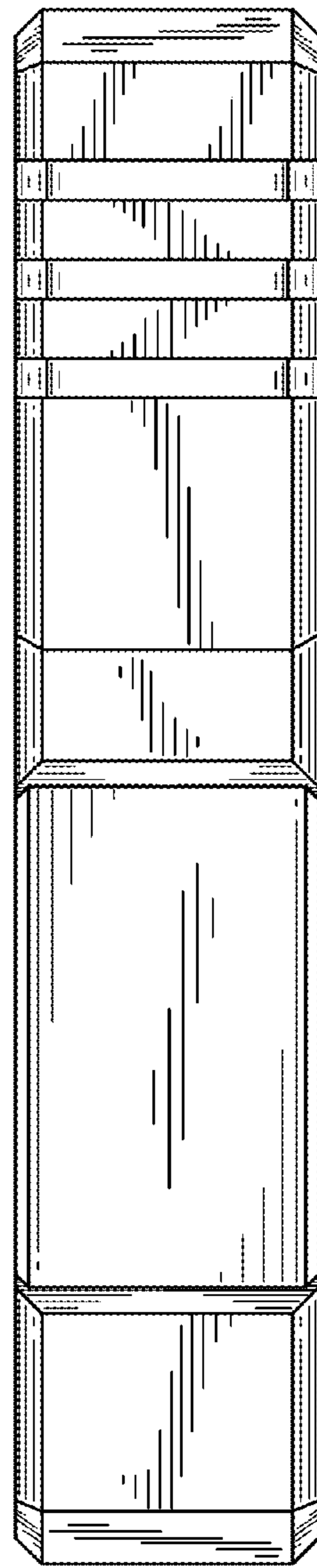

FIG. 21

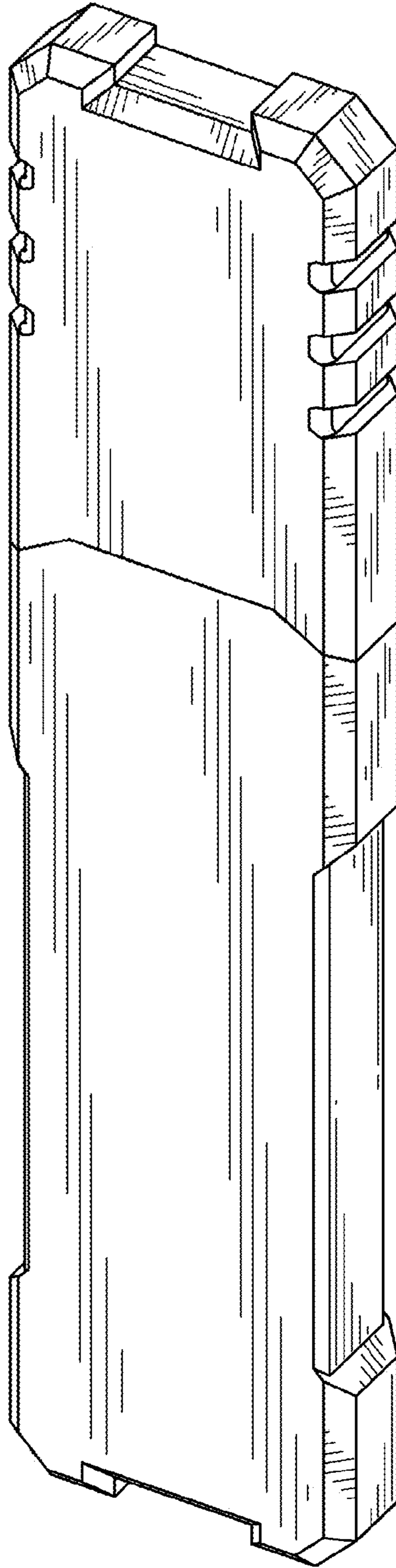

FIG. 22

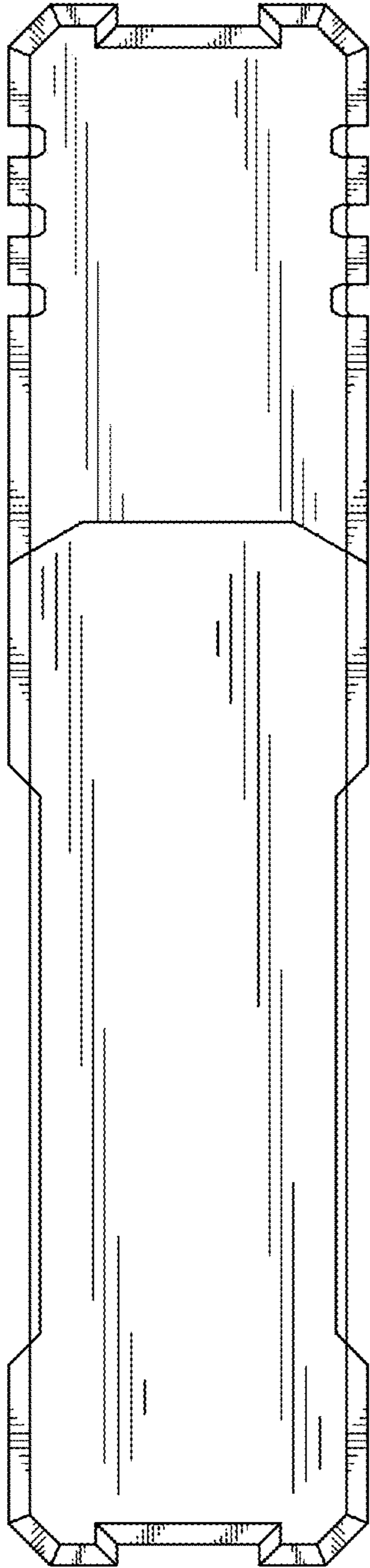

FIG. 23

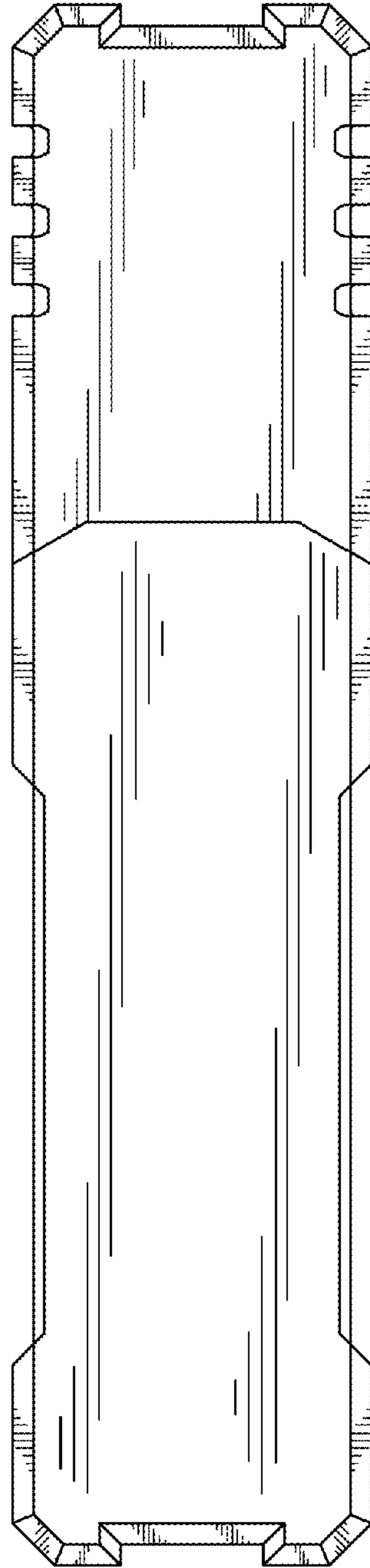

FIG. 24

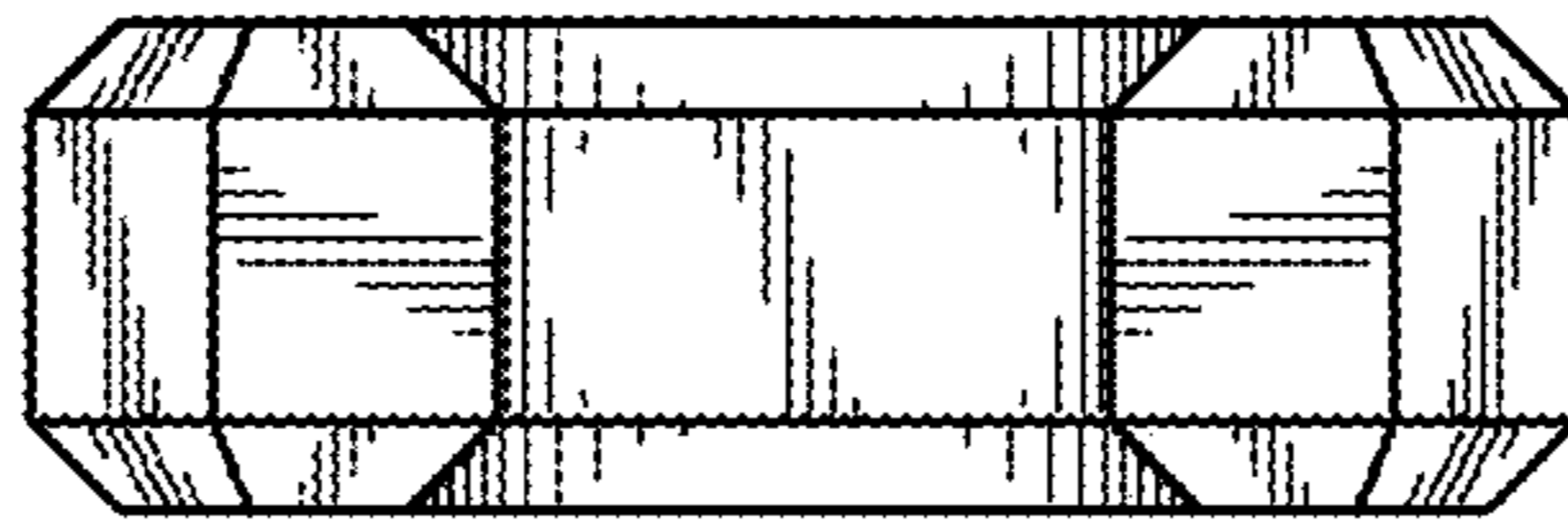

FIG. 25

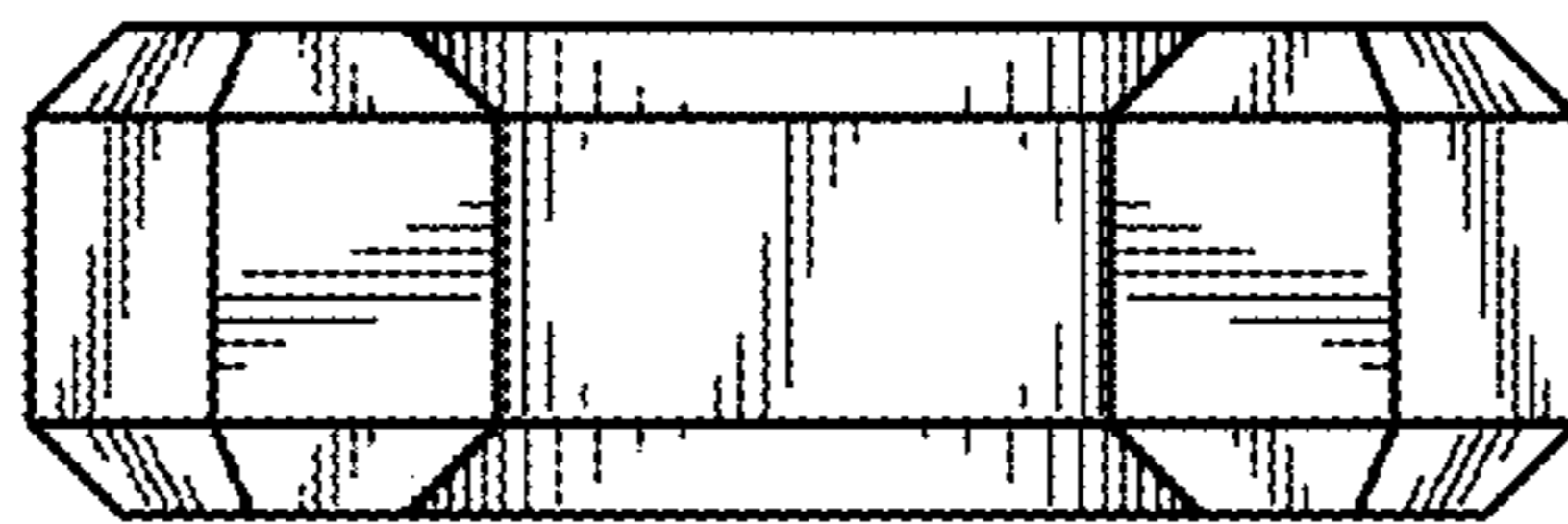

FIG. 26

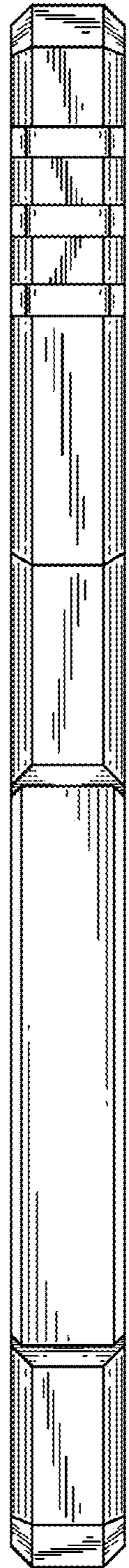

FIG. 27

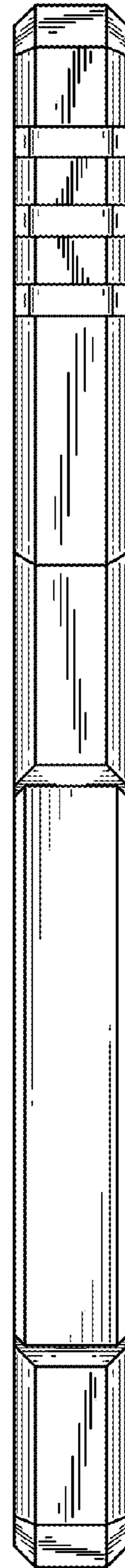

FIG. 28

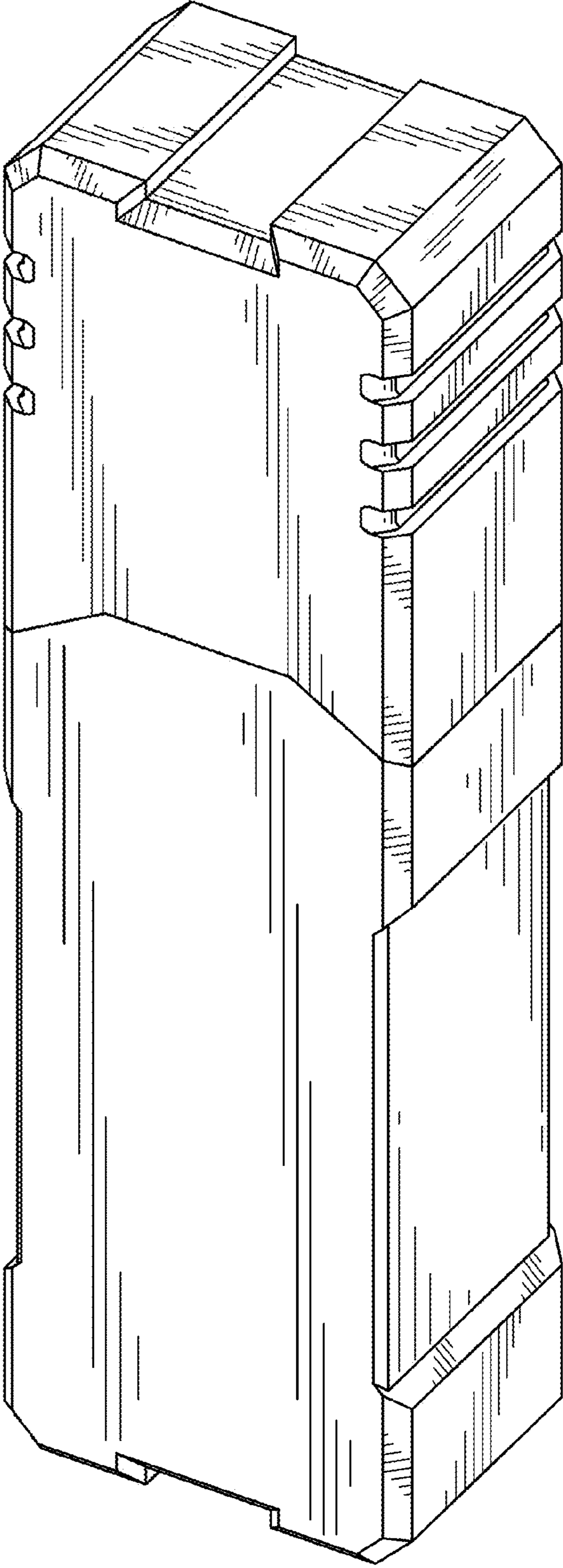

FIG. 29

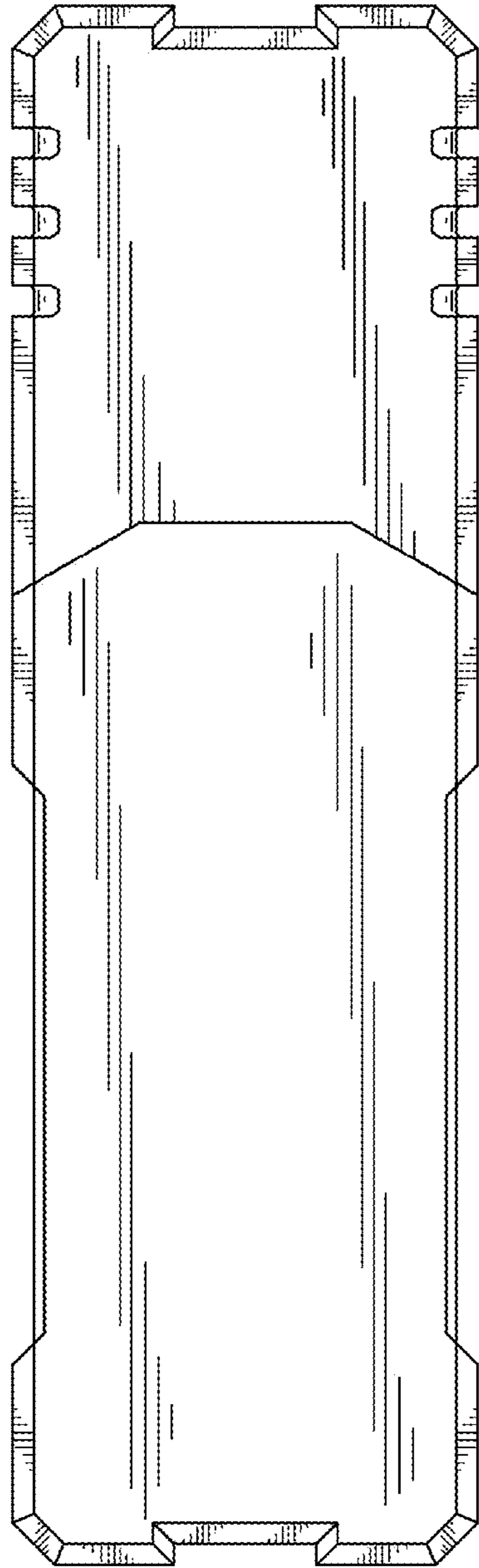

FIG. 30

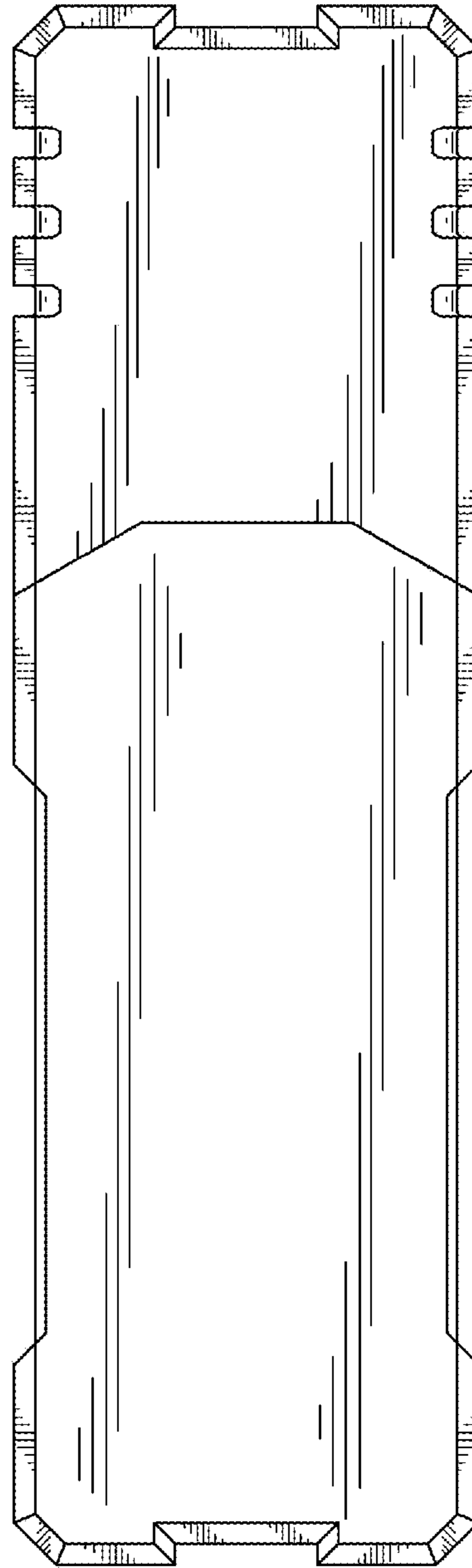

FIG. 31

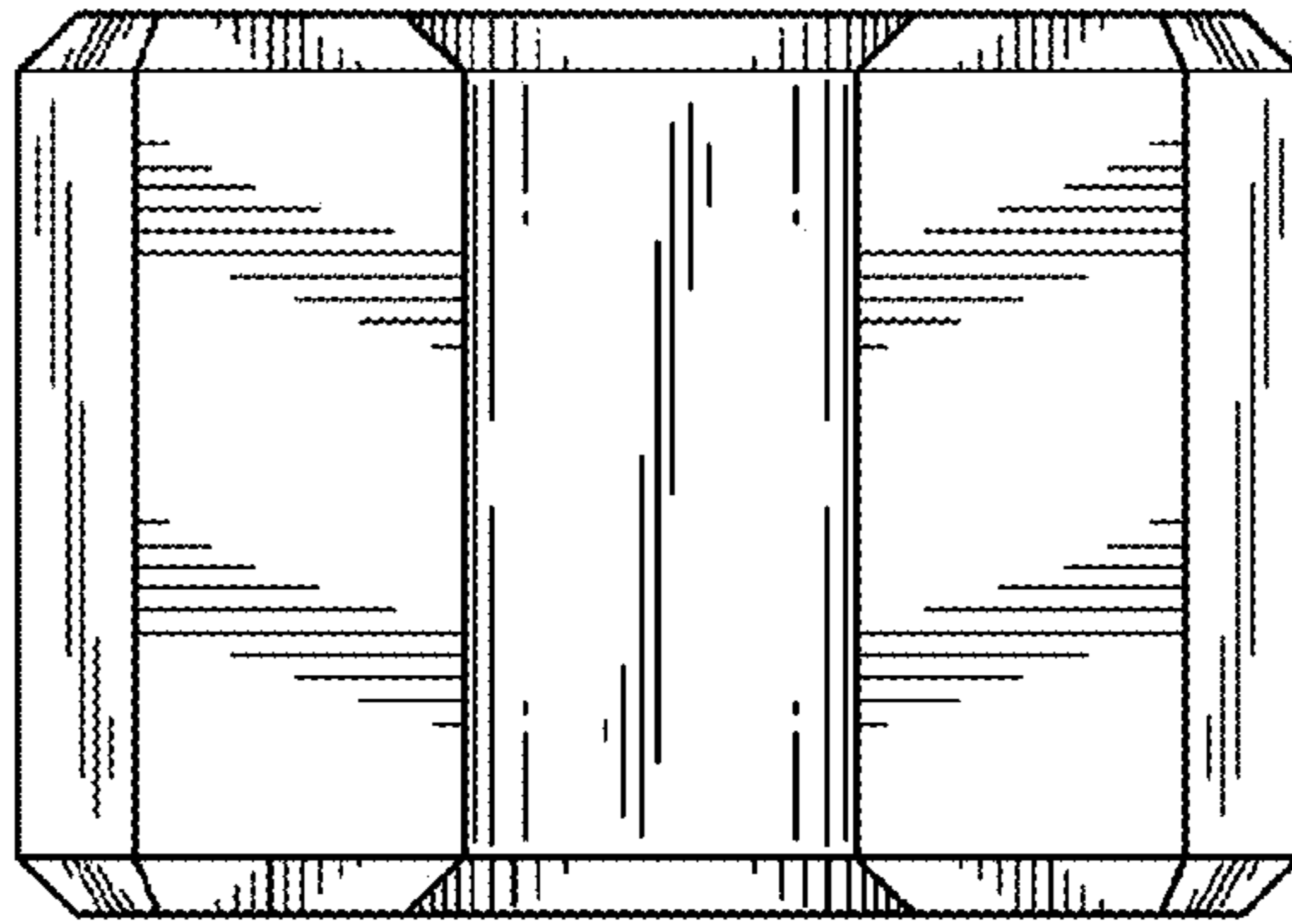

FIG. 32

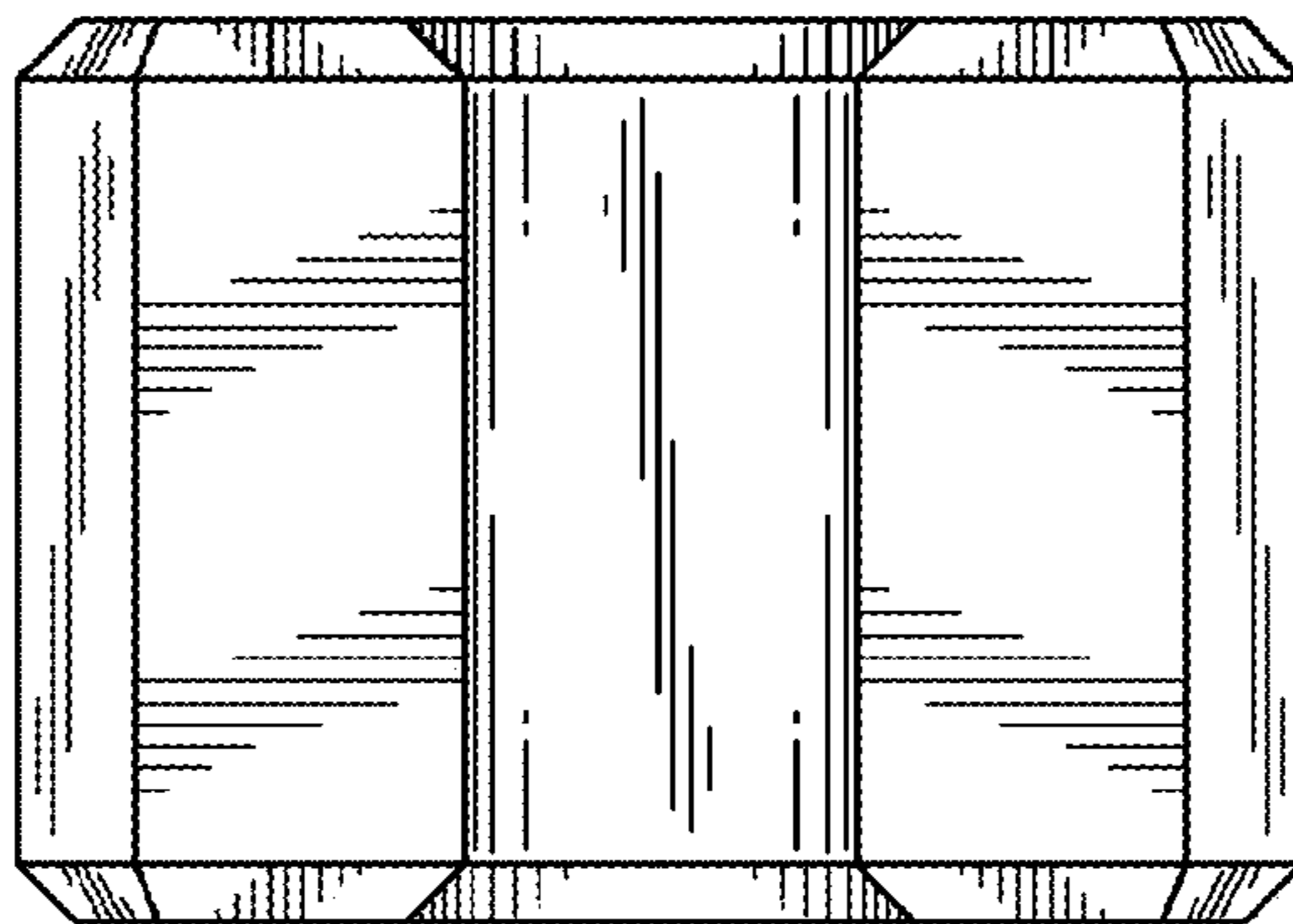

FIG. 33

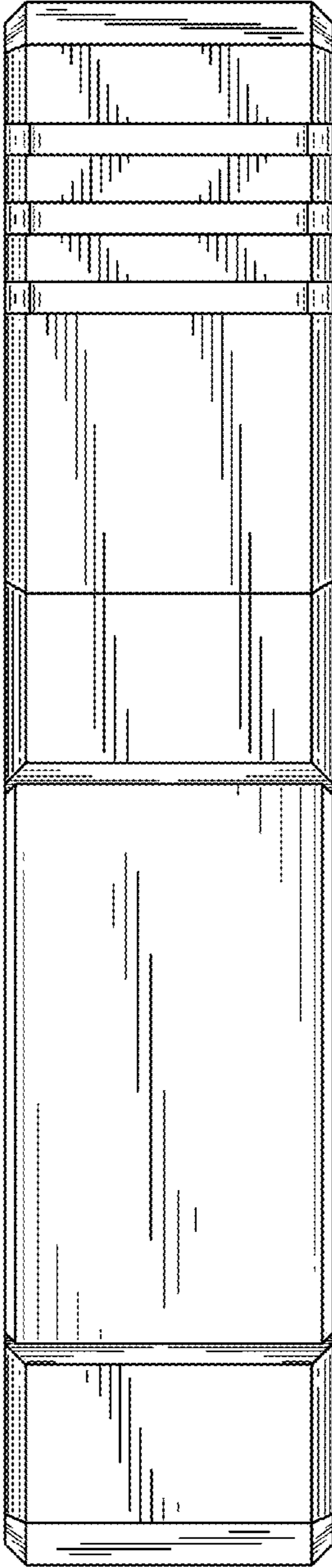

FIG. 34

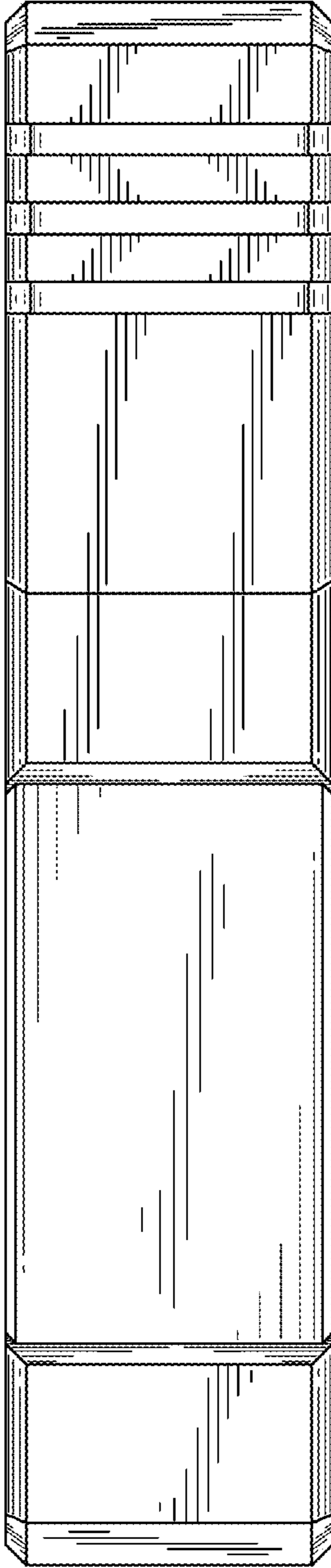

FIG. 35