



US00D692606S

(12) **United States Design Patent**
Schrimmer

(10) **Patent No.:** **US D692,606 S**

(45) **Date of Patent:** **** Oct. 29, 2013**

(54) **THREE-SIDED PUCK LIGHT**

(75) **Inventor:** **Jeffrey D. Schrimmer**, Highland Park, IL (US)

(73) **Assignee:** **I Pee Holding LLC**, Vernon Hills, IL (US)

(**) **Term:** **14 Years**

(21) **Appl. No.:** **29/425,430**

(22) **Filed:** **Jun. 22, 2012**

(51) **LOC (9) Cl.** **26-05**

(52) **U.S. Cl.**
USPC **D26/72**

(58) **Field of Classification Search**
USPC D26/1, 24, 72, 80, 83, 85, 86, 89, 91,
D26/118, 120, 124, 128, 131, 135; 362/133,
362/147, 453-456, 507

See application file for complete search history.

(56) **References Cited**

U.S. PATENT DOCUMENTS

D161,830	S	*	2/1951	Grossman	D26/128
3,440,748	A	*	4/1969	Hackley	40/600
D283,257	S	*	4/1986	Ikeda	D26/93
D284,109	S	*	6/1986	Seal, Jr.	D26/72
4,613,847	A	*	9/1986	Scolari et al.	362/486
D290,620	S	*	6/1987	Elmer	D20/10
D340,001	S	*	10/1993	Watkins	D26/72
D346,870	S	*	5/1994	Houssian	D26/26
D353,907	S	*	12/1994	Doria	D26/106

5,909,955	A	*	6/1999	Roorda	362/368
6,186,635	B1	*	2/2001	Peterson et al.	362/84
6,641,283	B1	*	11/2003	Bohler	362/238
6,979,107	B1	*	12/2005	Benensohn	362/374
D603,550	S	*	11/2009	Levine	D26/80
D667,986	S	*	9/2012	Decq	D26/89
8,256,934	B2	*	9/2012	Cunius	362/373
D668,375	S	*	10/2012	Daniels	D26/89
2005/0270801	A1	*	12/2005	Torgerson	362/615
2006/0250789	A1	*	11/2006	Coushaine	362/157

* cited by examiner

Primary Examiner — Clare E Heflin

(74) *Attorney, Agent, or Firm* — Levenfeld Pearlstein, LLC

(57) **CLAIM**

The ornamental design for a three-sided puck light, as shown and described.

DESCRIPTION

FIG. 1 is a front, top perspective view of a three-sided puck light embodying my new design;
FIG. 2 is a top view thereof;
FIG. 3 is a bottom view thereof;
FIG. 4 is a front view as seen from the bottom of FIG. 2;
FIG. 5 is a rear view thereof;
FIG. 6 is a side view thereof as seen rotated 30 degrees from FIG. 4; and,
FIG. 7 is a side view thereof rotated 60 degrees from FIG. 4.

1 Claim, 1 Drawing Sheet

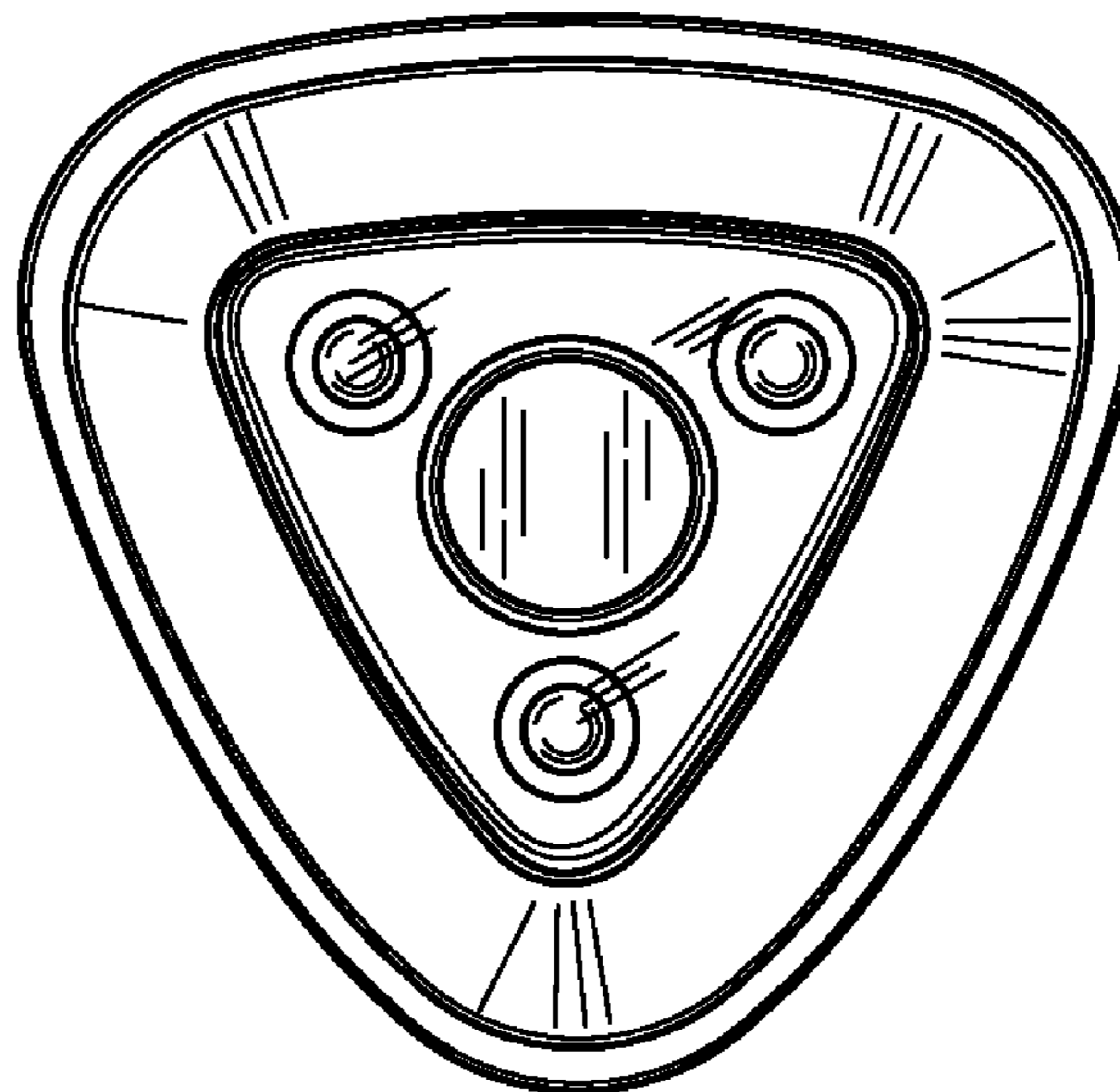
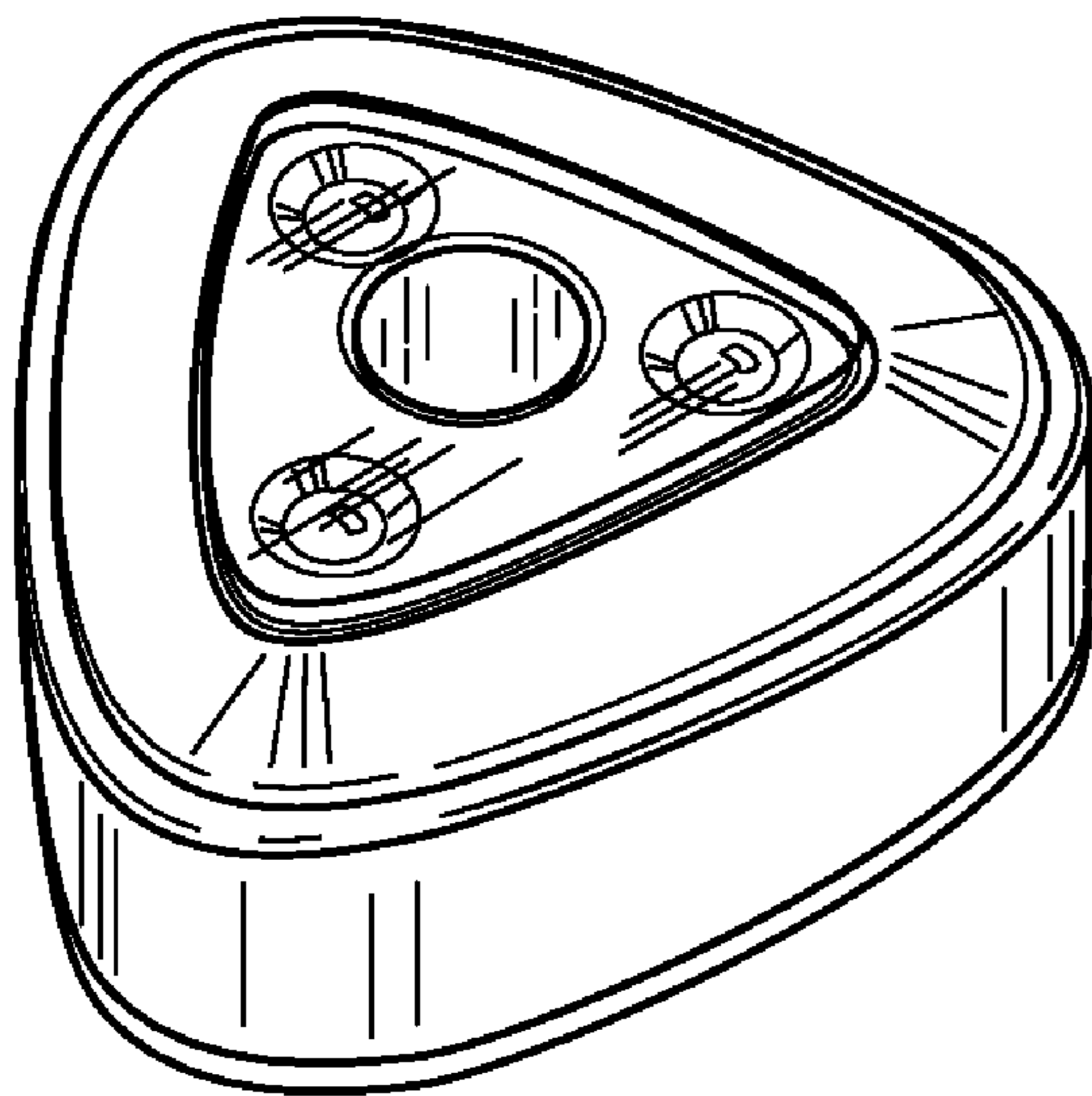

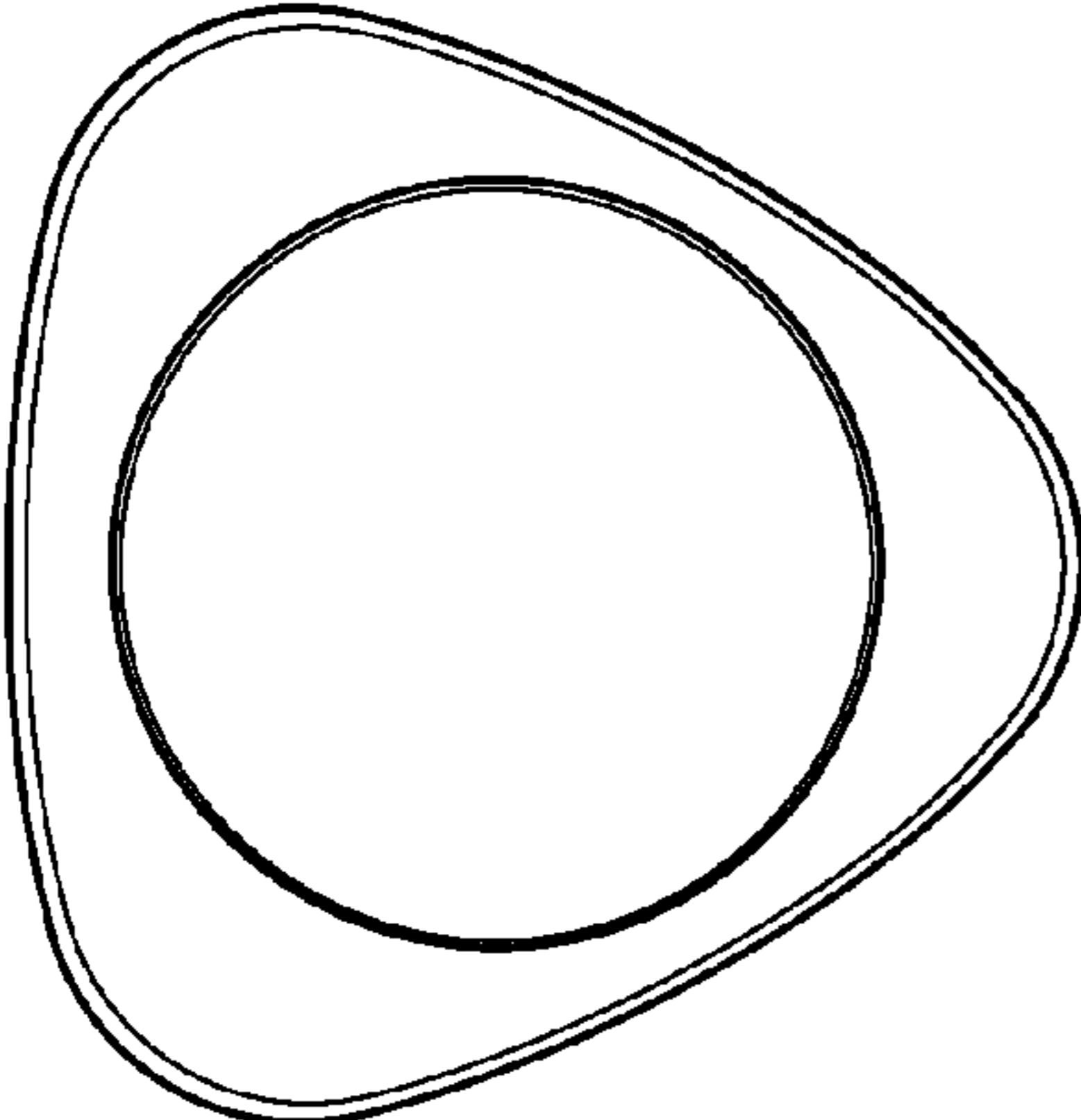

FIG. 3

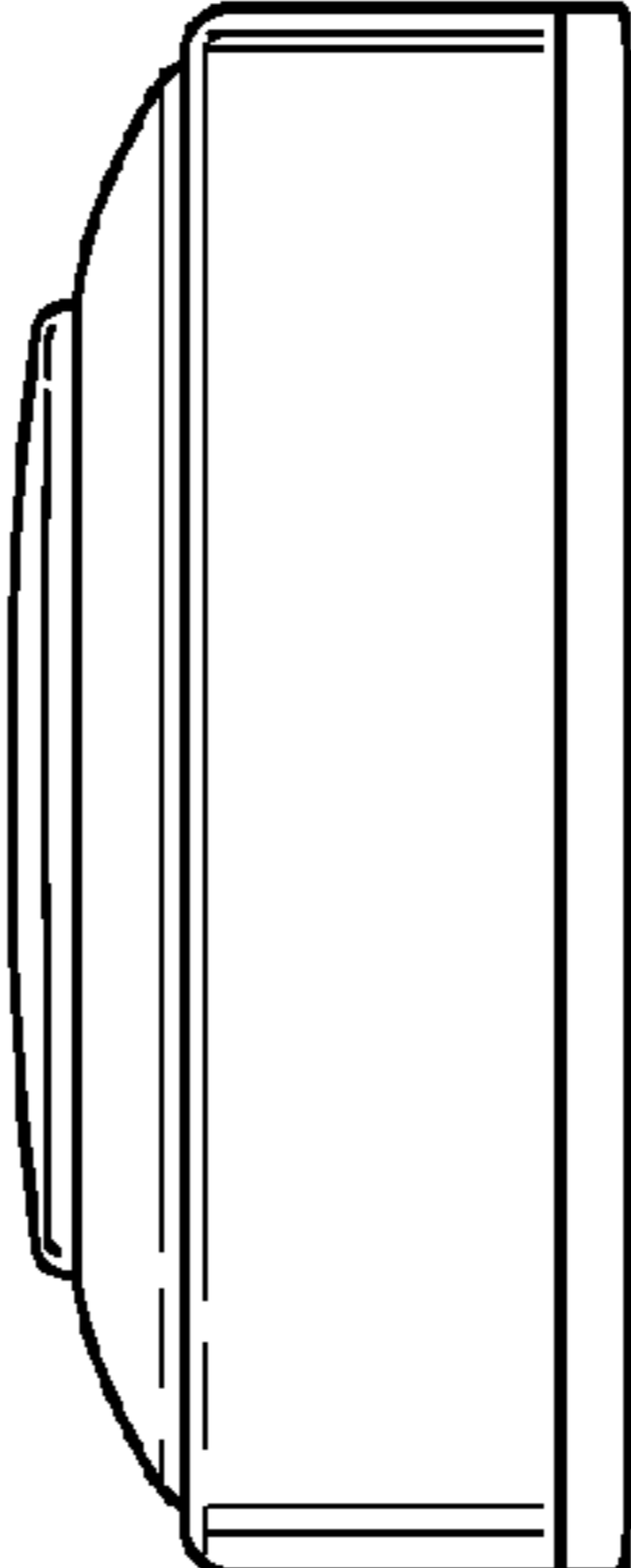

FIG. 5

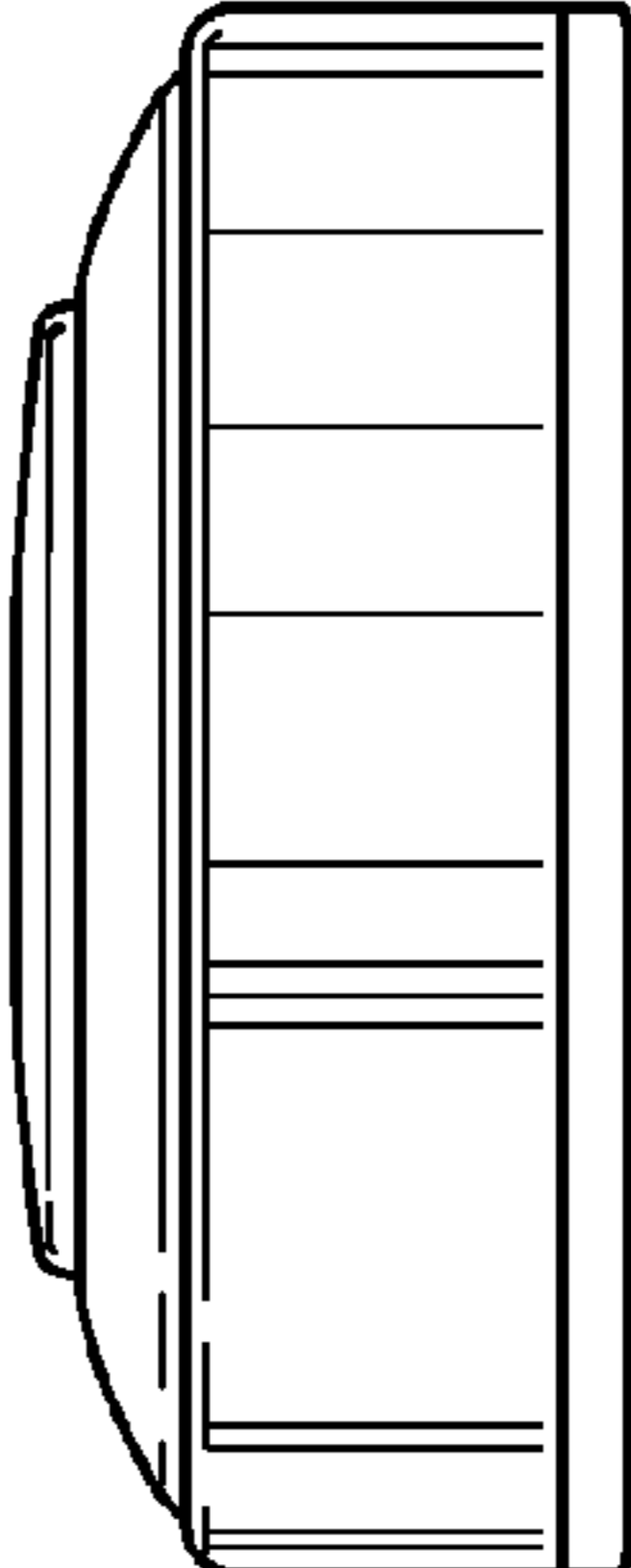

FIG. 7

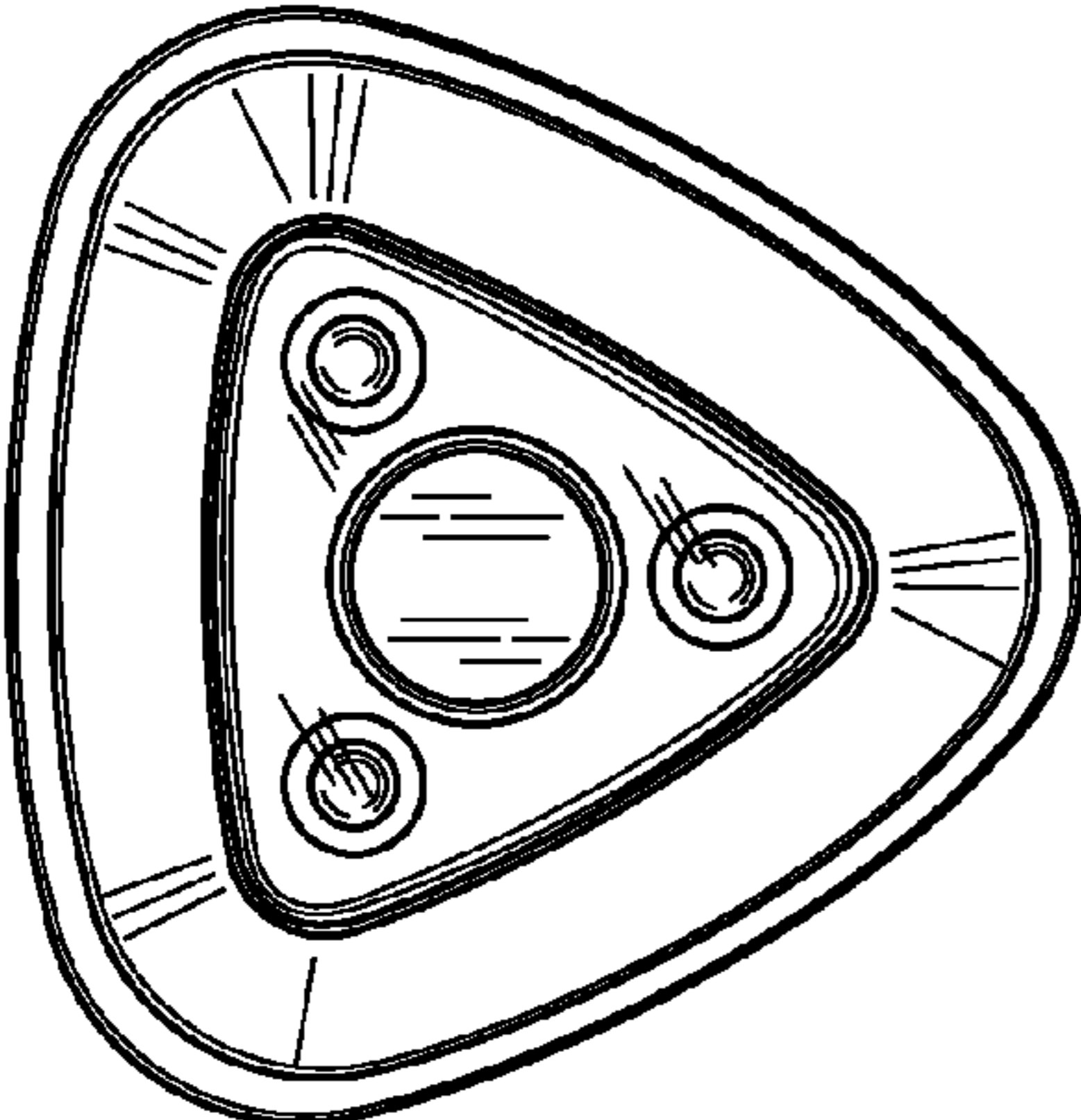

FIG. 2

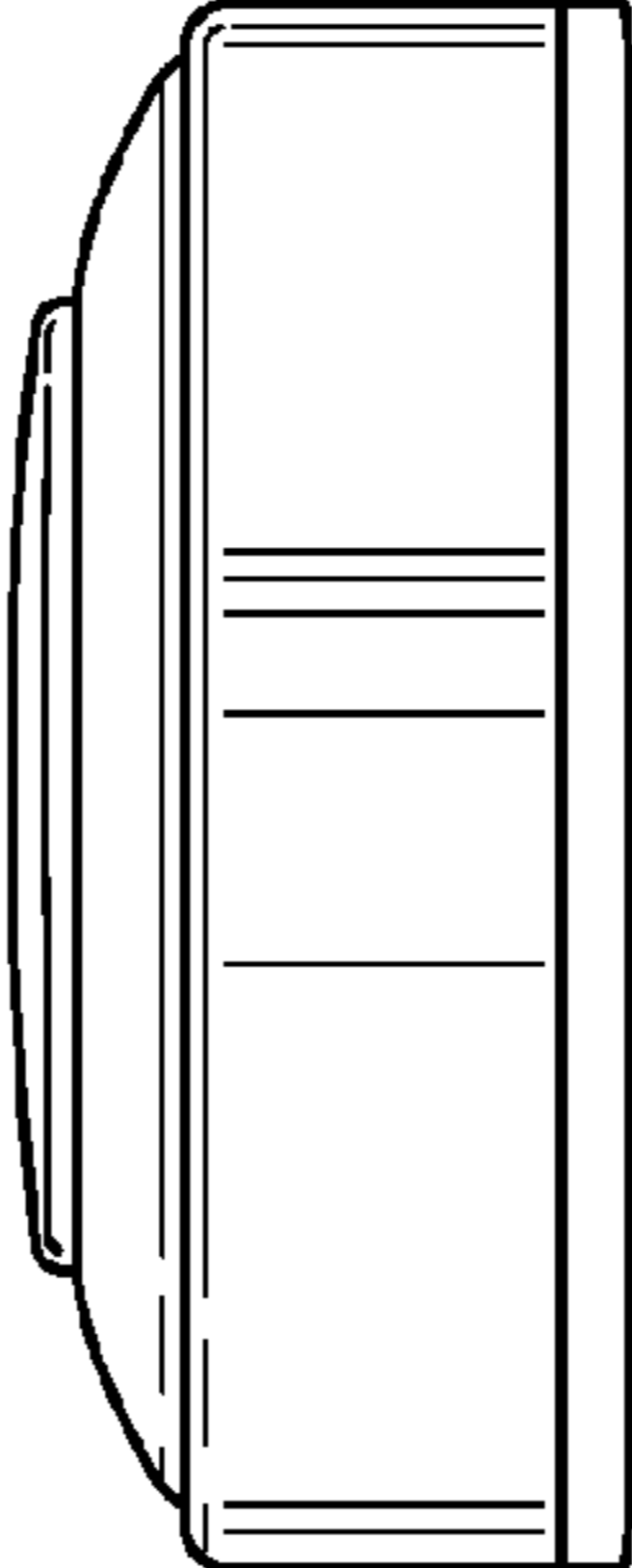

FIG. 4

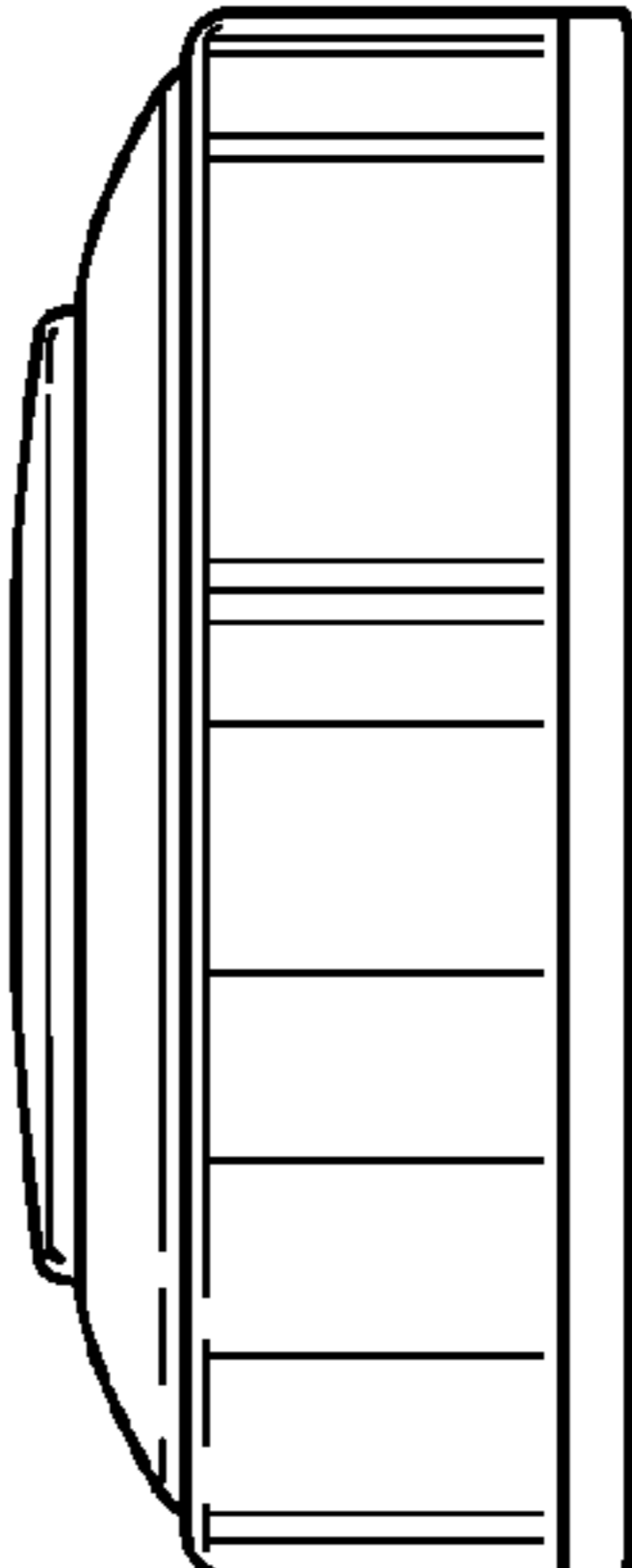

FIG. 6

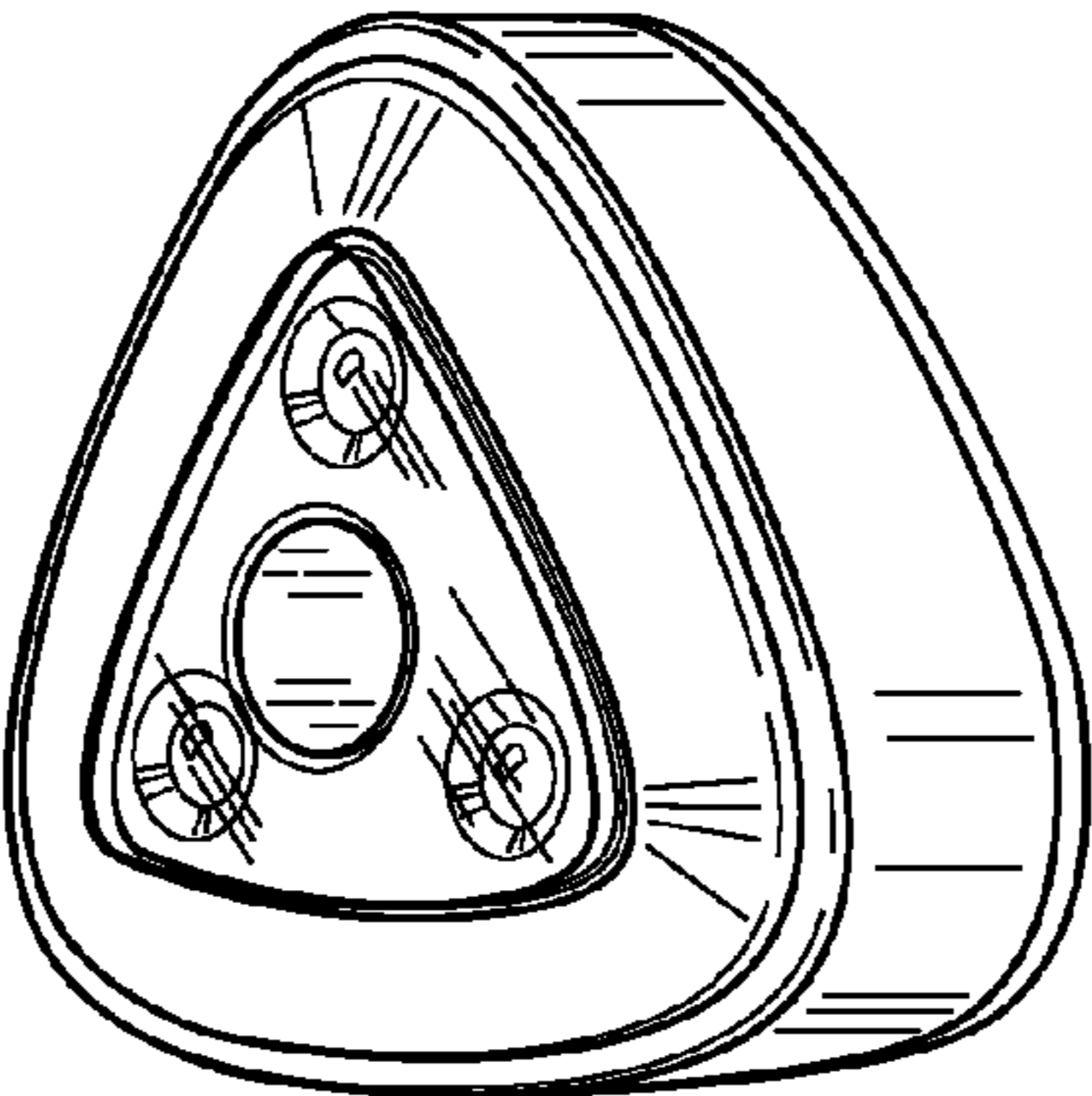

FIG. 1