

US00D692571S

(12) **United States Design Patent**
Luzon et al.

(10) **Patent No.:** **US D692,571 S**
(45) **Date of Patent:** **** Oct. 29, 2013**

- (54) **SKIN TIGHTENING DEVICE**
- (75) Inventors: **Josef Luzon**, Bet Yehoshua (IL); **Martin Gurovich**, Tel Aviv (IL)
- (73) Assignee: **Derma Dream Group Ltd.**, Road Town, Tortola (VG)
- (**) Term: **14 Years**
- (21) Appl. No.: **29/432,317**
- (22) Filed: **Sep. 14, 2012**
- (51) **LOC (9) Cl.** **28-03**
- (52) **U.S. Cl.**
USPC **D24/215**
- (58) **Field of Classification Search**
USPC D24/200, 211, 212, 213, 214, 215;
601/114, 120, 121, 124, 125, 130, 131,
601/134, 135, 136, 137
See application file for complete search history.

7,128,722	B2 *	10/2006	Lev et al.	601/108
7,491,184	B2 *	2/2009	Huang	601/103
D611,159	S *	3/2010	Cole et al.	D24/200
D617,000	S *	6/2010	Mills	D24/215
D620,597	S *	7/2010	Cole et al.	D24/200
D627,898	S *	11/2010	Aulwes et al.	D24/214
D628,304	S *	11/2010	Aulwes et al.	D24/214
D629,118	S *	12/2010	Yeo	D24/214
2002/0161315	A1 *	10/2002	Harris et al.	601/84
2006/0094994	A1 *	5/2006	Huang	601/108

* cited by examiner

Primary Examiner — Sandra Snapp
(74) *Attorney, Agent, or Firm* — Pearl Cohen Zedek Latzer Baratz, LLP

(57) **CLAIM**
The ornamental design for a skin tightening device, as shown and described.

DESCRIPTION

FIG. 1 is a top, front, right side perspective view of the skin tightening device;
FIG. 2 is a front elevational view thereof;
FIG. 3 is a back elevational view thereof;
FIG. 4 is a right side elevational view thereof;
FIG. 5 is a left side elevational view thereof;
FIG. 6 is a bottom plan view thereof; and,
FIG. 7 is a top plan view thereof.
The structure in broken lines forms no part of the claimed design.

1 Claim, 4 Drawing Sheets

- (56) **References Cited**
U.S. PATENT DOCUMENTS
- | | | | | | |
|-----------|------|---------|---------------|-------|---------|
| D281,625 | S * | 12/1985 | Yuen | | D24/211 |
| D323,034 | S * | 1/1992 | Reinstein | | D24/206 |
| D350,608 | S * | 9/1994 | Yu | | D24/214 |
| D366,703 | S * | 1/1996 | Huen | | D24/214 |
| D415,838 | S * | 10/1999 | Noble | | D24/215 |
| D435,913 | S * | 1/2001 | Harris et al. | | D24/215 |
| D438,308 | S * | 2/2001 | Harris et al. | | D24/215 |
| 6,500,135 | B2 * | 12/2002 | Huang | | 601/108 |
| D476,746 | S * | 7/2003 | Harris et al. | | D24/215 |
| 6,730,050 | B2 * | 5/2004 | Huang | | 601/93 |

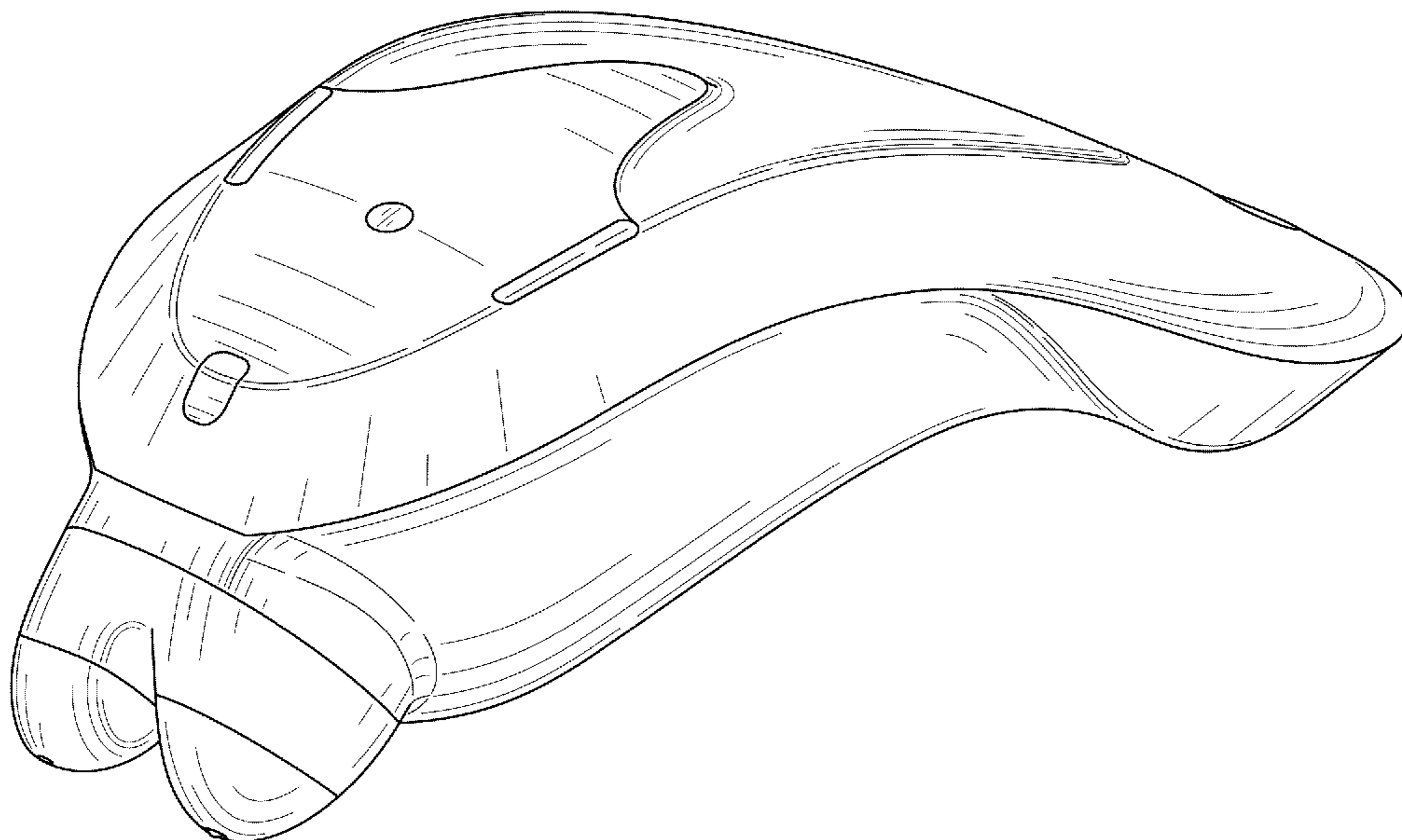

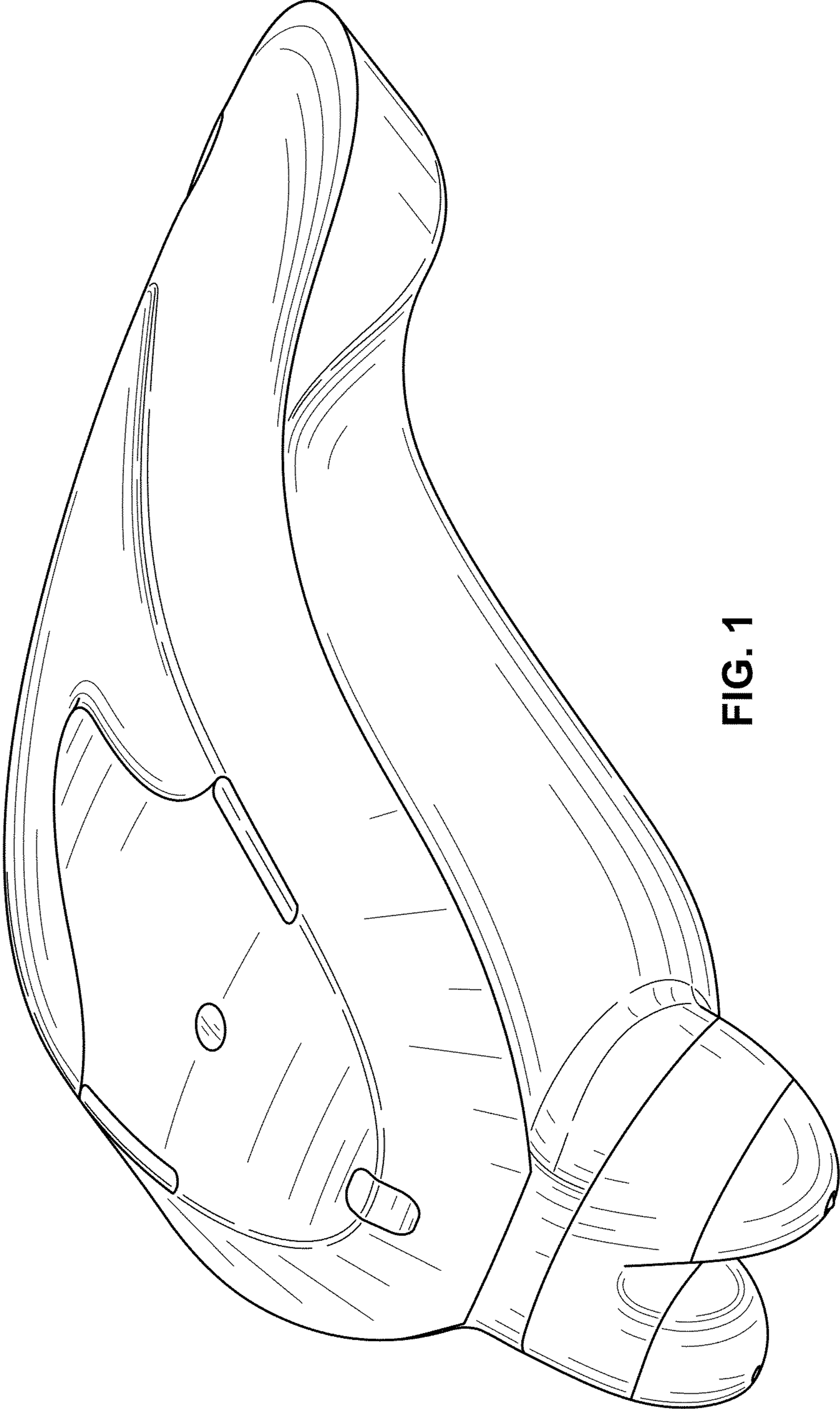

FIG. 1

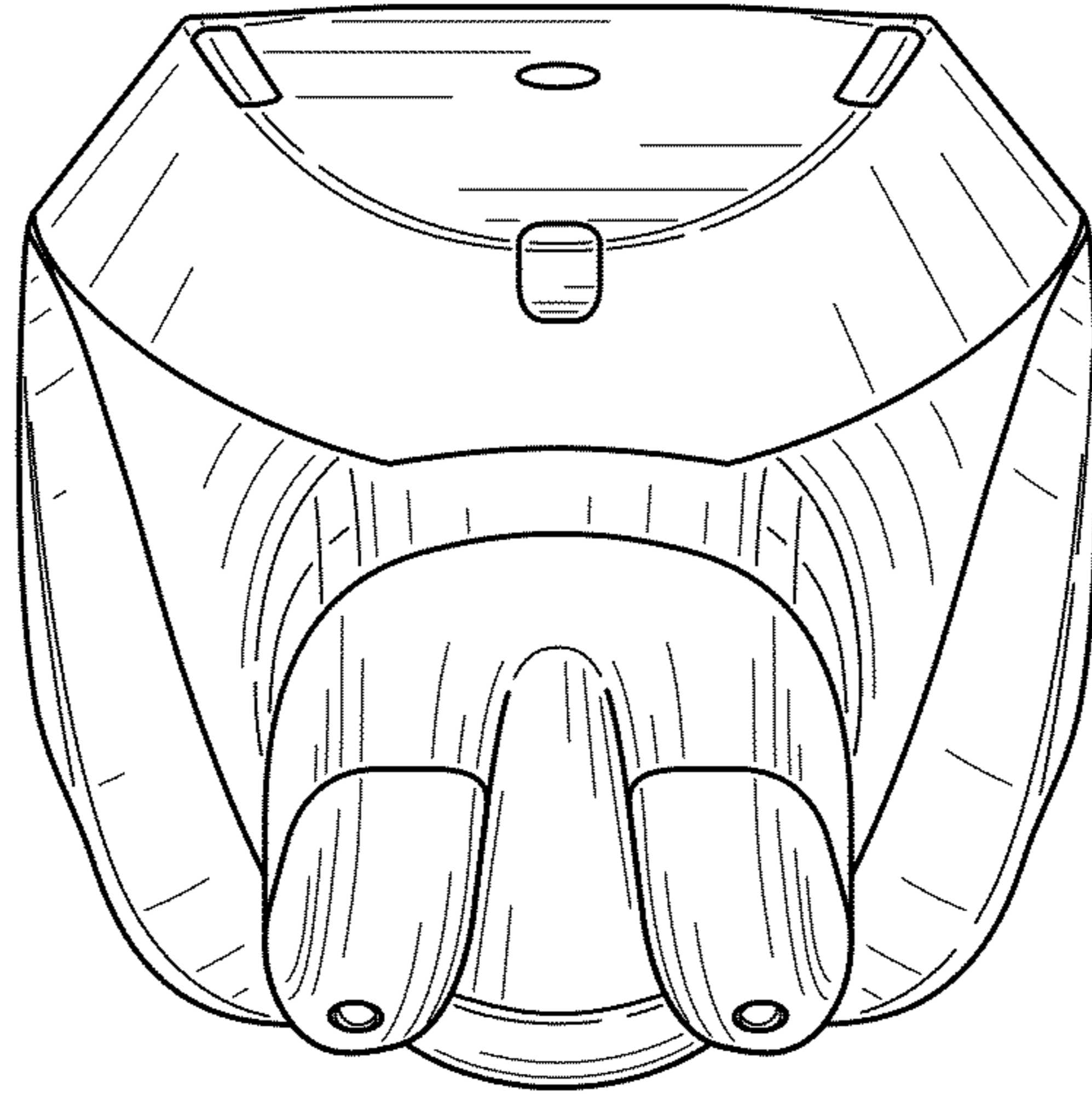

FIG. 2

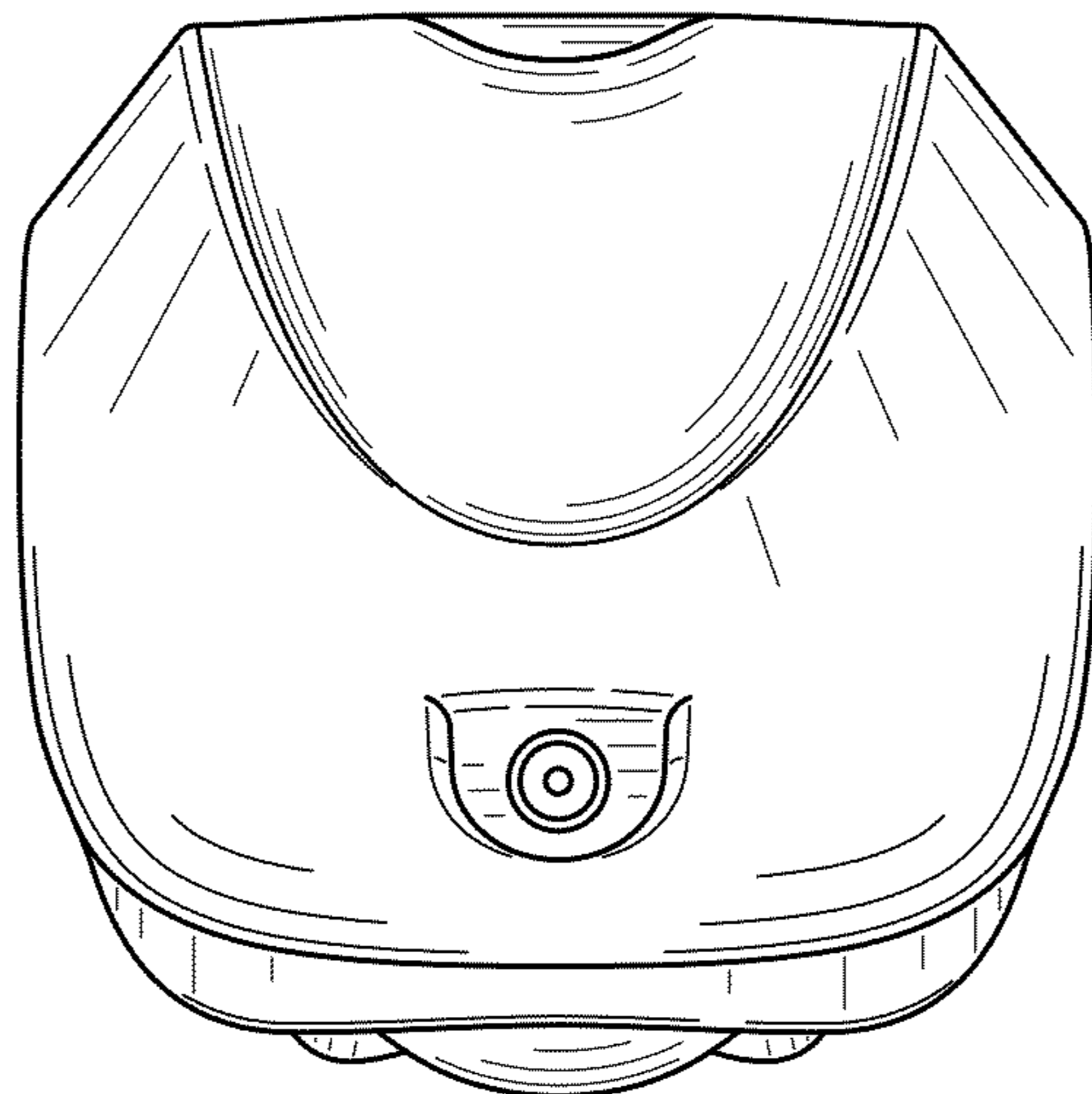

FIG. 3

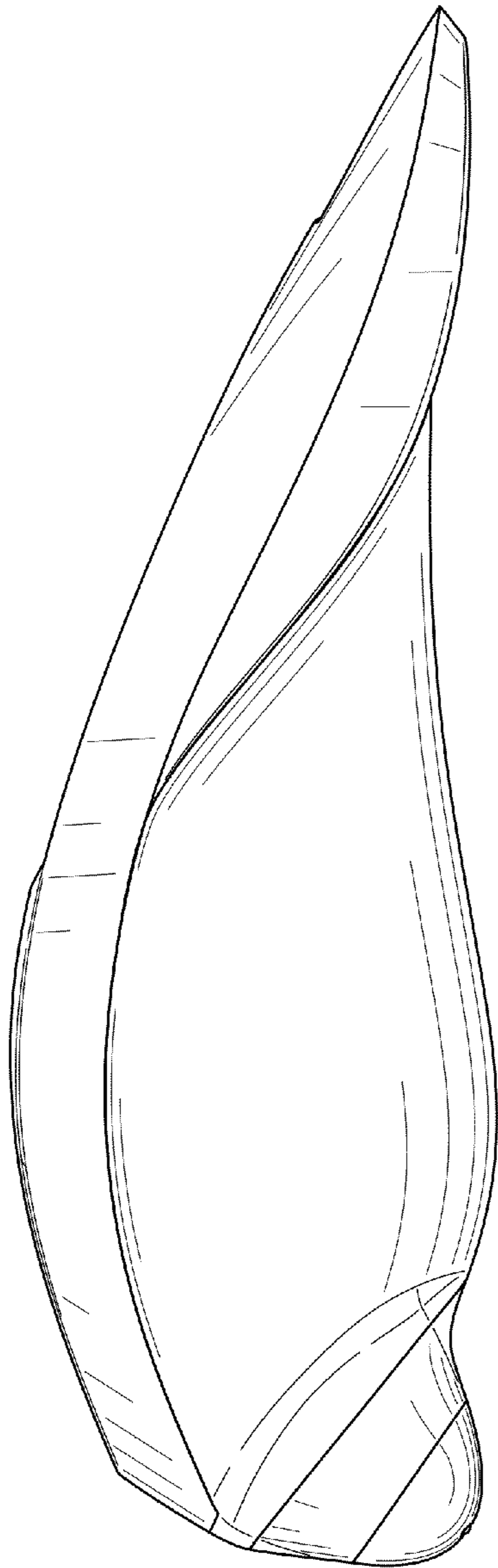

FIG. 4

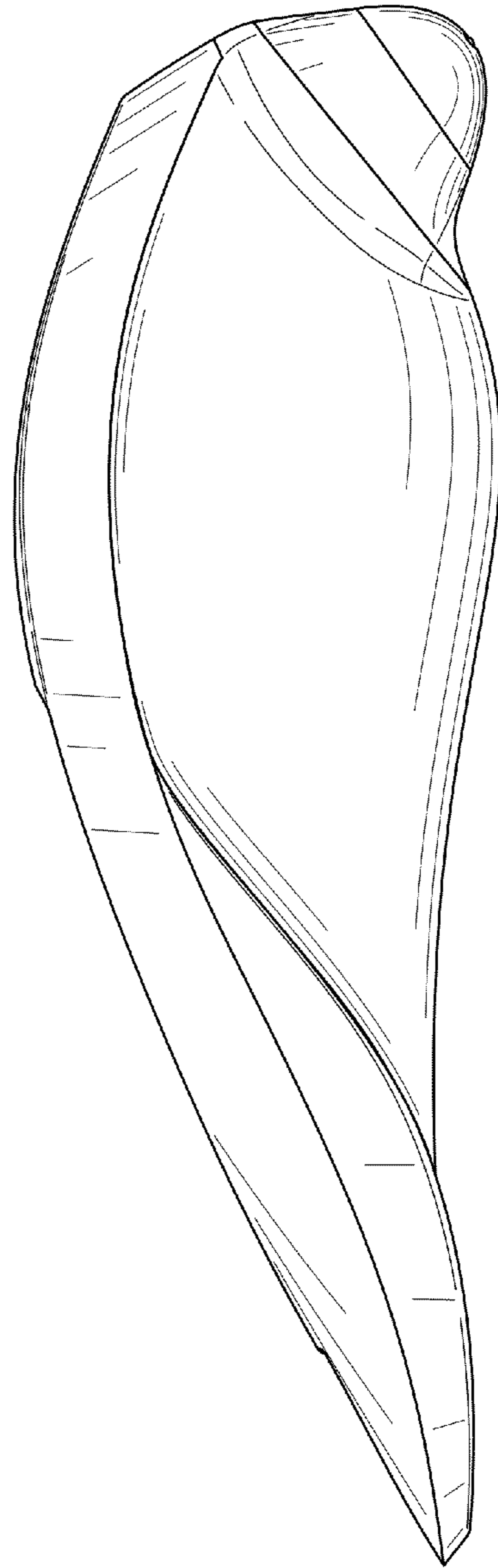

FIG. 5

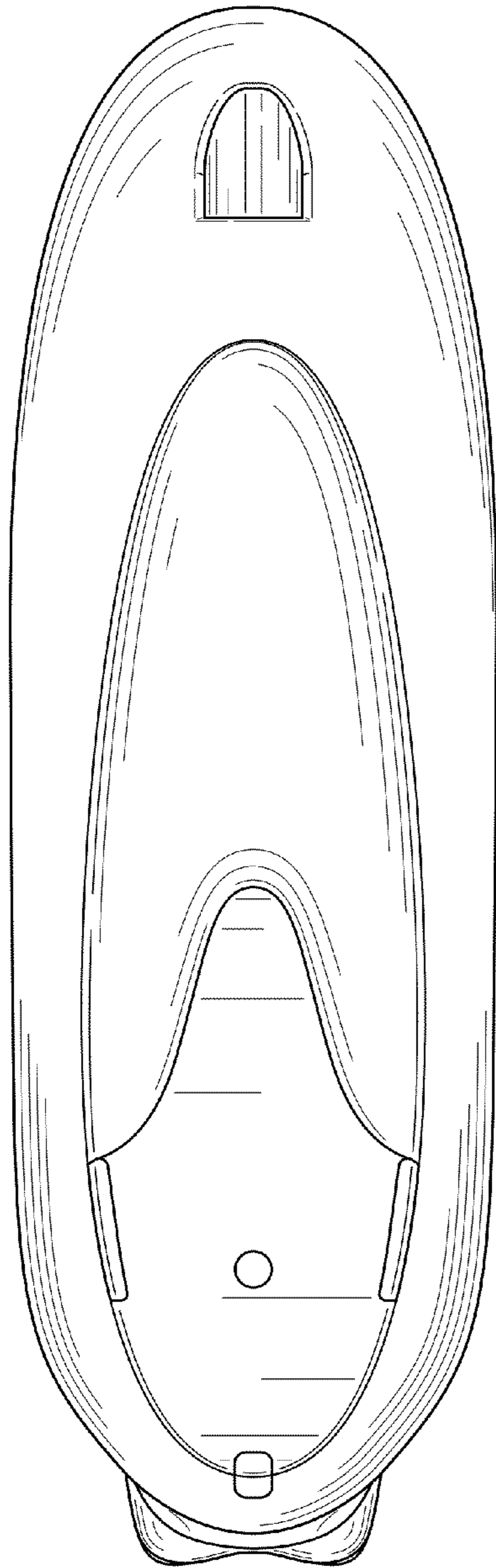

FIG. 6

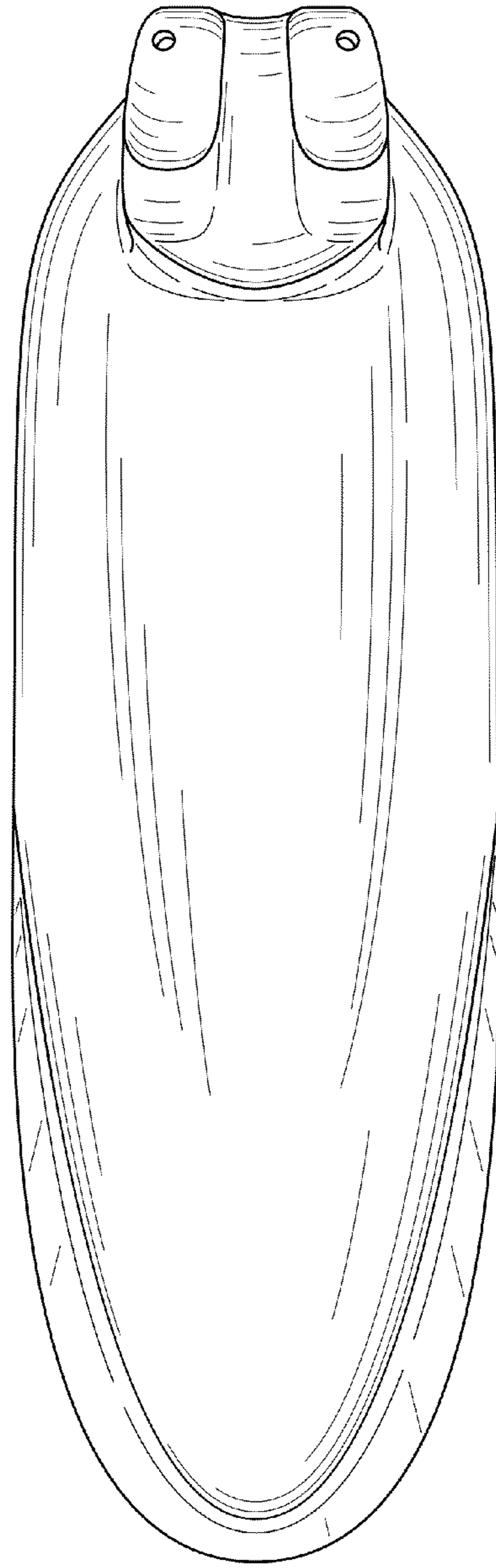

FIG. 7