



US00D692537S

(12) **United States Design Patent**
Starck

(10) **Patent No.:** **US D692,537 S**
(45) **Date of Patent:** **** Oct. 29, 2013**

(54) **WALL-MOUNTED FAUCET**

FOREIGN PATENT DOCUMENTS

(75) Inventor: **Philippe Starck**, Paris (FR)
(73) Assignee: **Hansgrohe SE**, Schiltach (DE)
(**) Term: **14 Years**

DE	40201581.9	2/2002
EM	000114103-0001	12/2003
EM	000114103-0002	12/2003
EM	000125000-0005	1/2004
EM	000125000-0006	1/2004

* cited by examiner

(21) Appl. No.: **29/431,631**

Primary Examiner — Robert Delehanty

(22) Filed: **Sep. 10, 2012**

(74) *Attorney, Agent, or Firm* — Nirav D. Parikh

(30) **Foreign Application Priority Data**

(57) **CLAIM**

Mar. 16, 2012 (EM) 001318273-0031

The ornamental design for a wall-mounted faucet, as shown and described.

(51) **LOC (9) Cl.** **23-01**

DESCRIPTION

(52) **U.S. Cl.**
USPC **D23/238**

(58) **Field of Classification Search**
USPC D23/238–243, 249–250, 255, 257;
4/675–678; 138/801

FIG. 1 is a perspective view of a wall-mounted faucet showing my design;
FIG. 2 is a front elevational view thereof;
FIG. 3 is a rear elevational view thereof;
FIG. 4 is a left side elevational view thereof;
FIG. 5 is a right side elevational view thereof;
FIG. 6 is a top plan view thereof; and,
FIG. 7 is a bottom plan view thereof.

See application file for complete search history.

The broken-line disclosure in the views represents portions of the article in which the claimed design is embodied, but which form no part of the claimed design.

(56) **References Cited**

U.S. PATENT DOCUMENTS

D457,603 S *	5/2002	Lobermeier	D23/242
D514,200 S *	1/2006	Starck	D23/238
D667,087 S *	9/2012	Shieh	D23/239

1 Claim, 7 Drawing Sheets

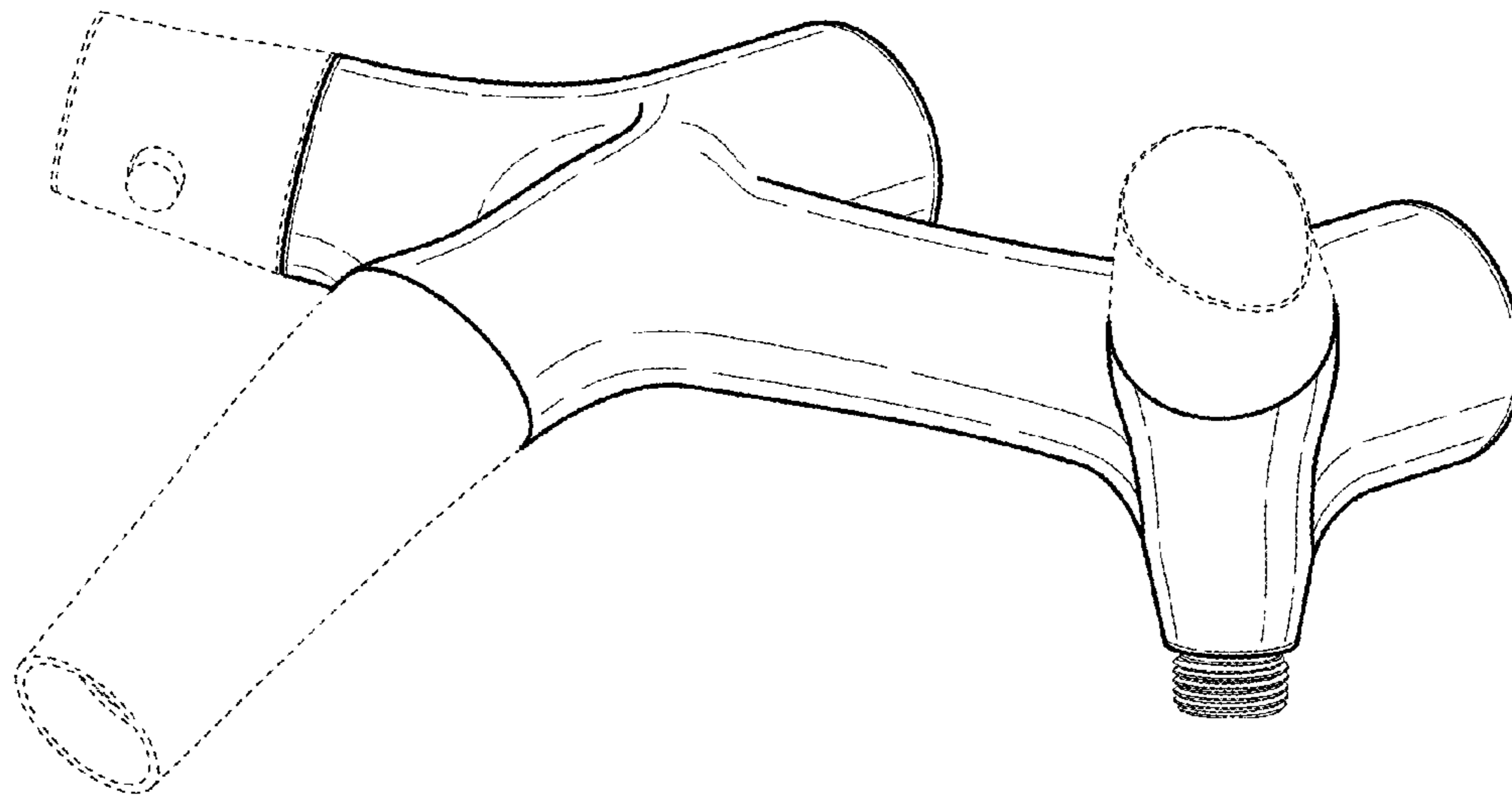

FIG. 1

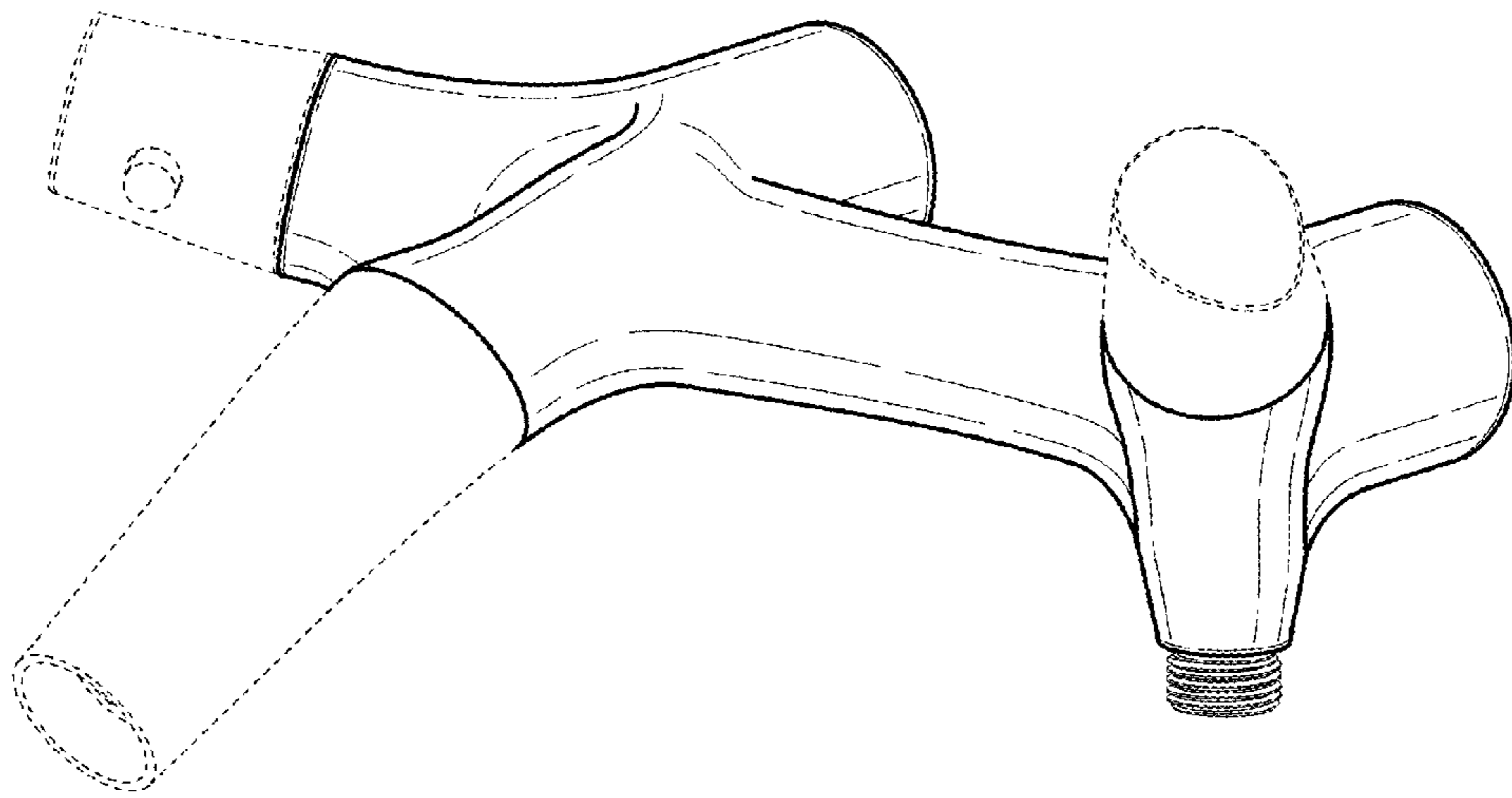

FIG. 2

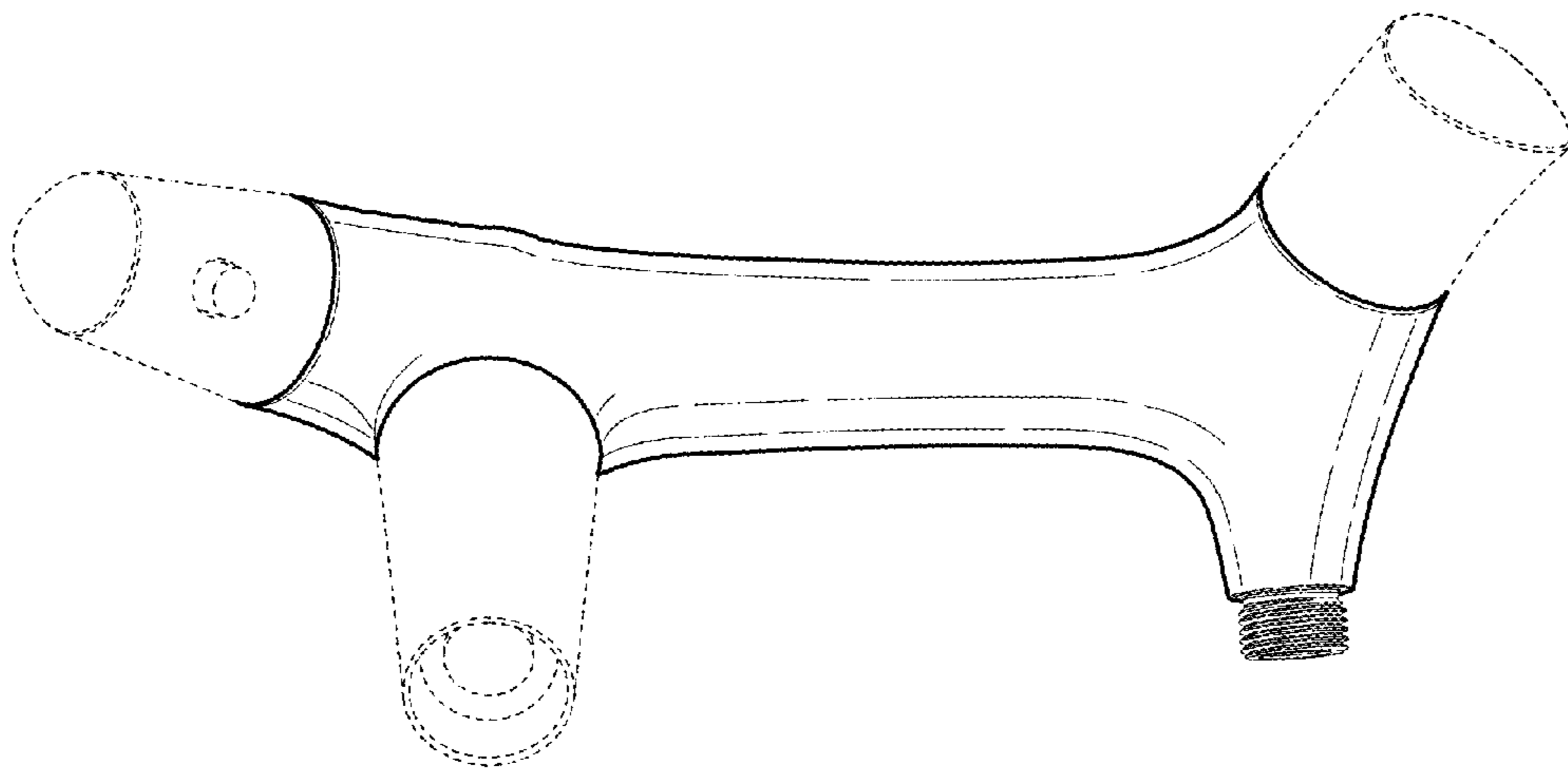

FIG. 3

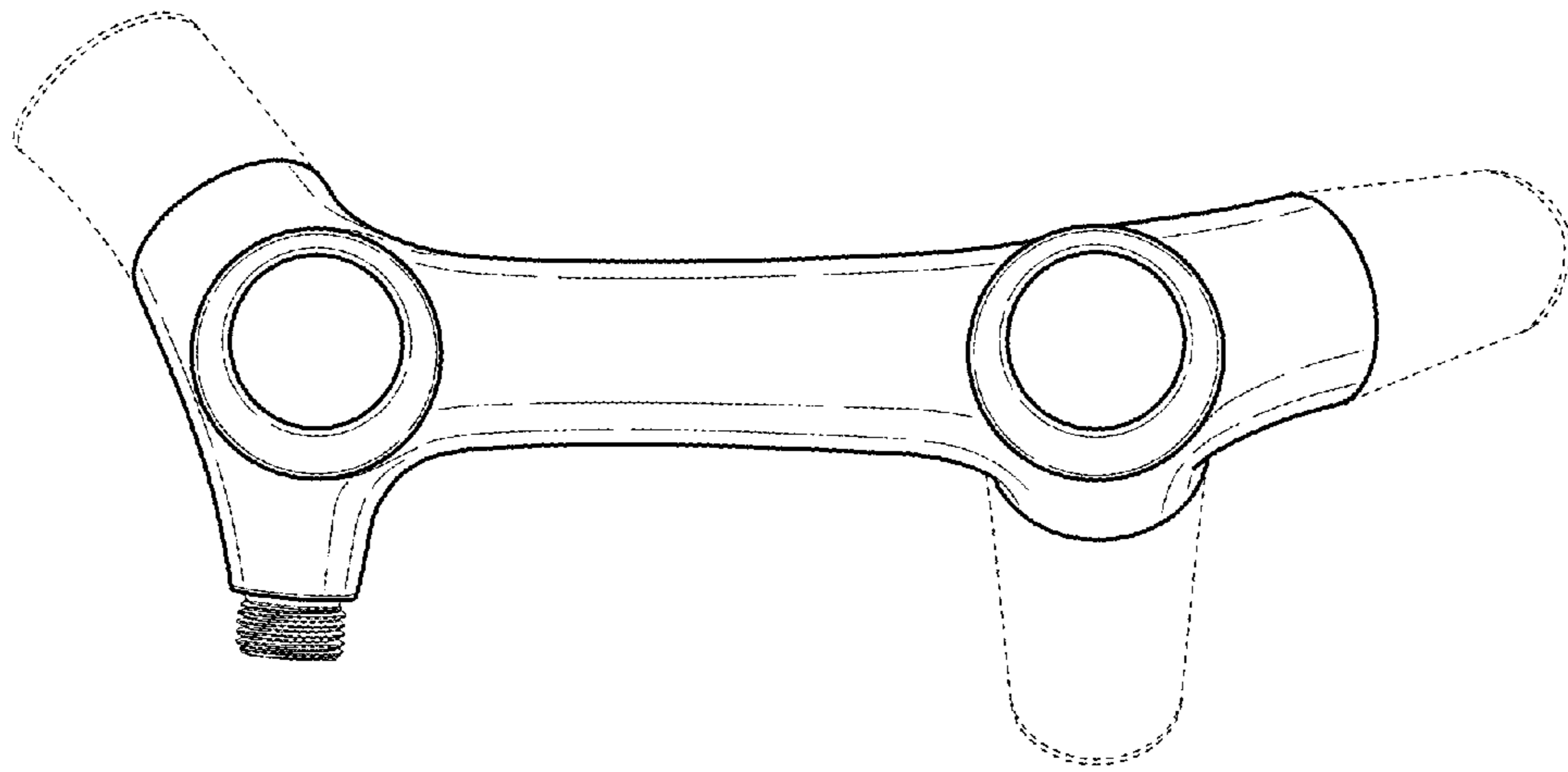

FIG. 4

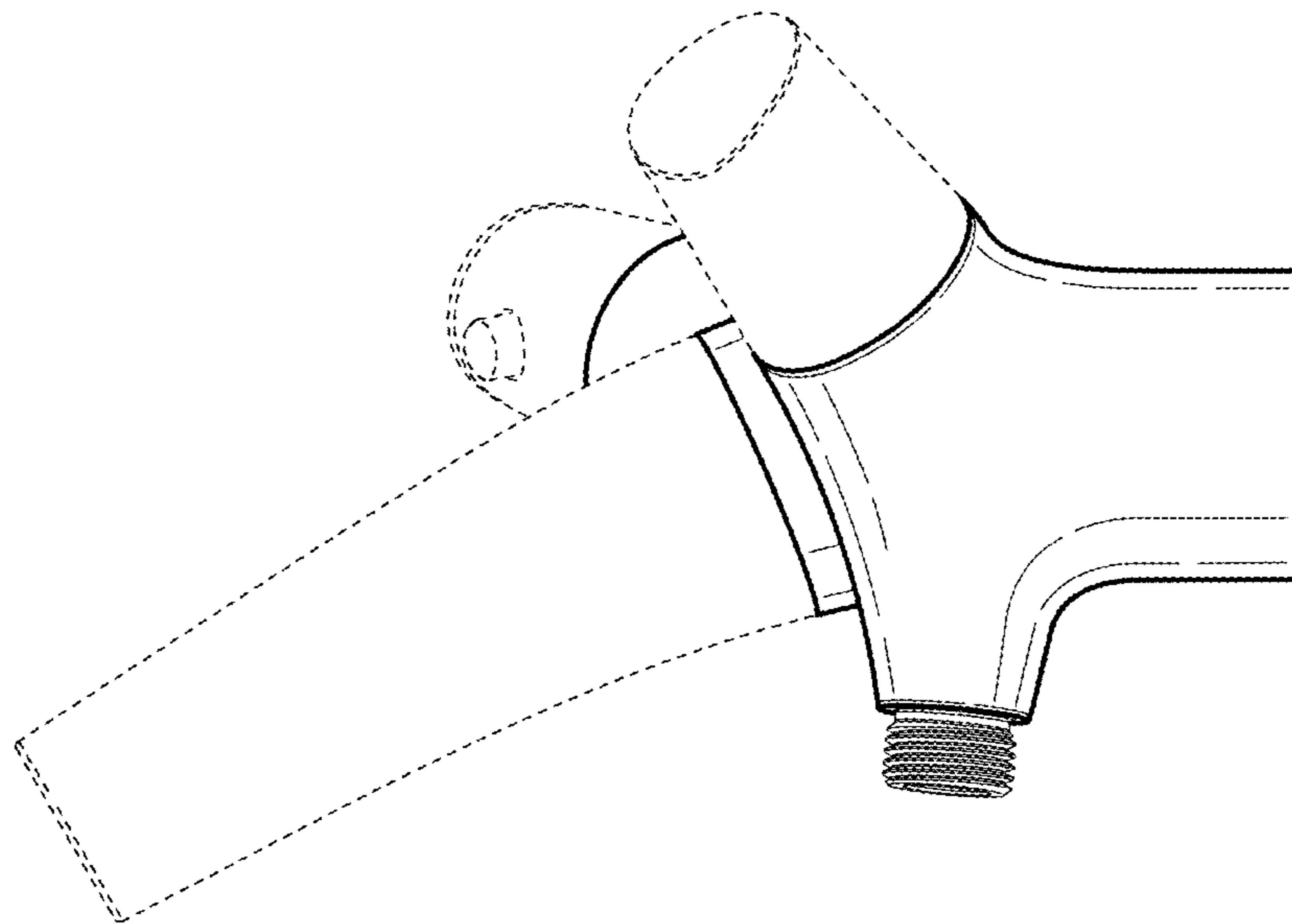

FIG. 5

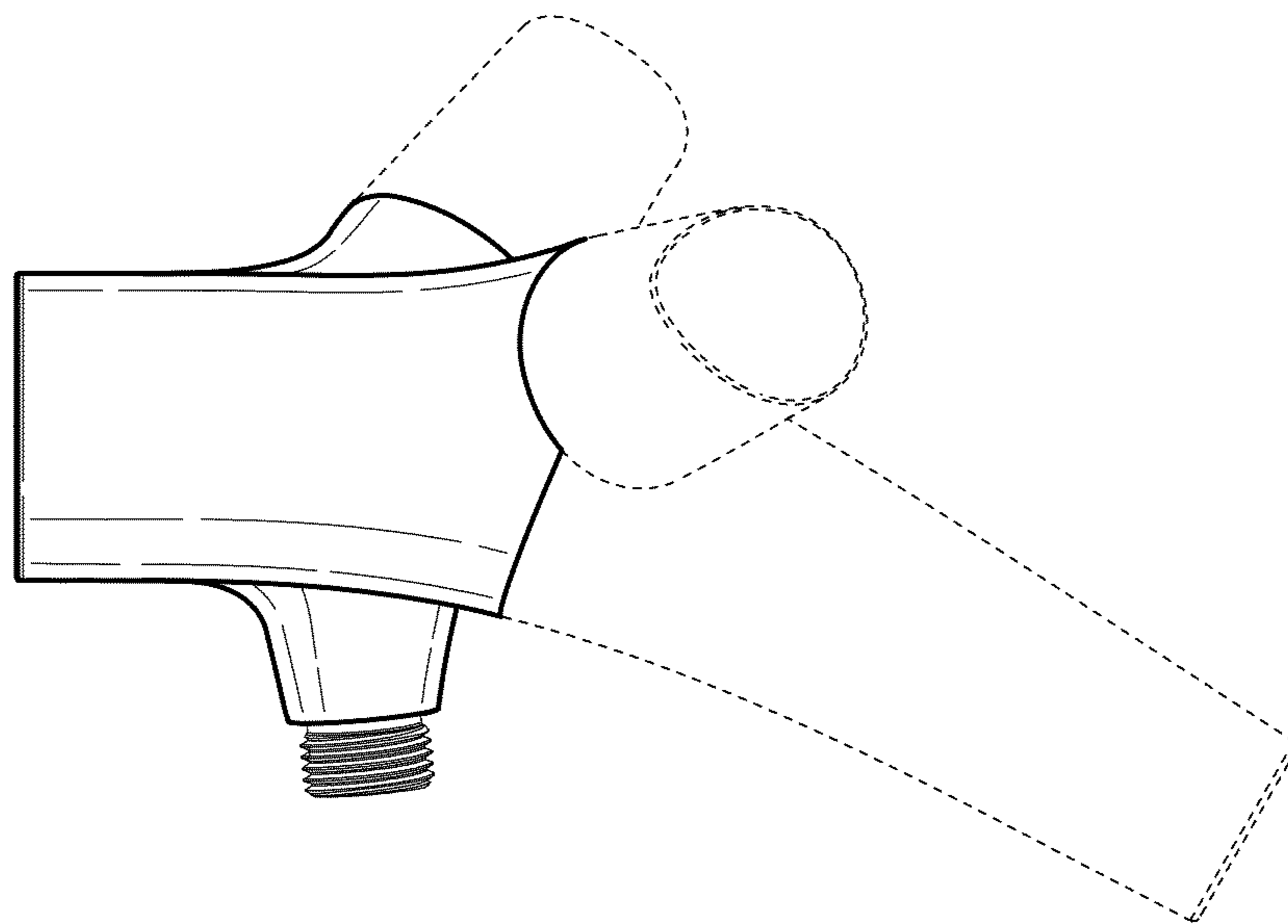

FIG. 6

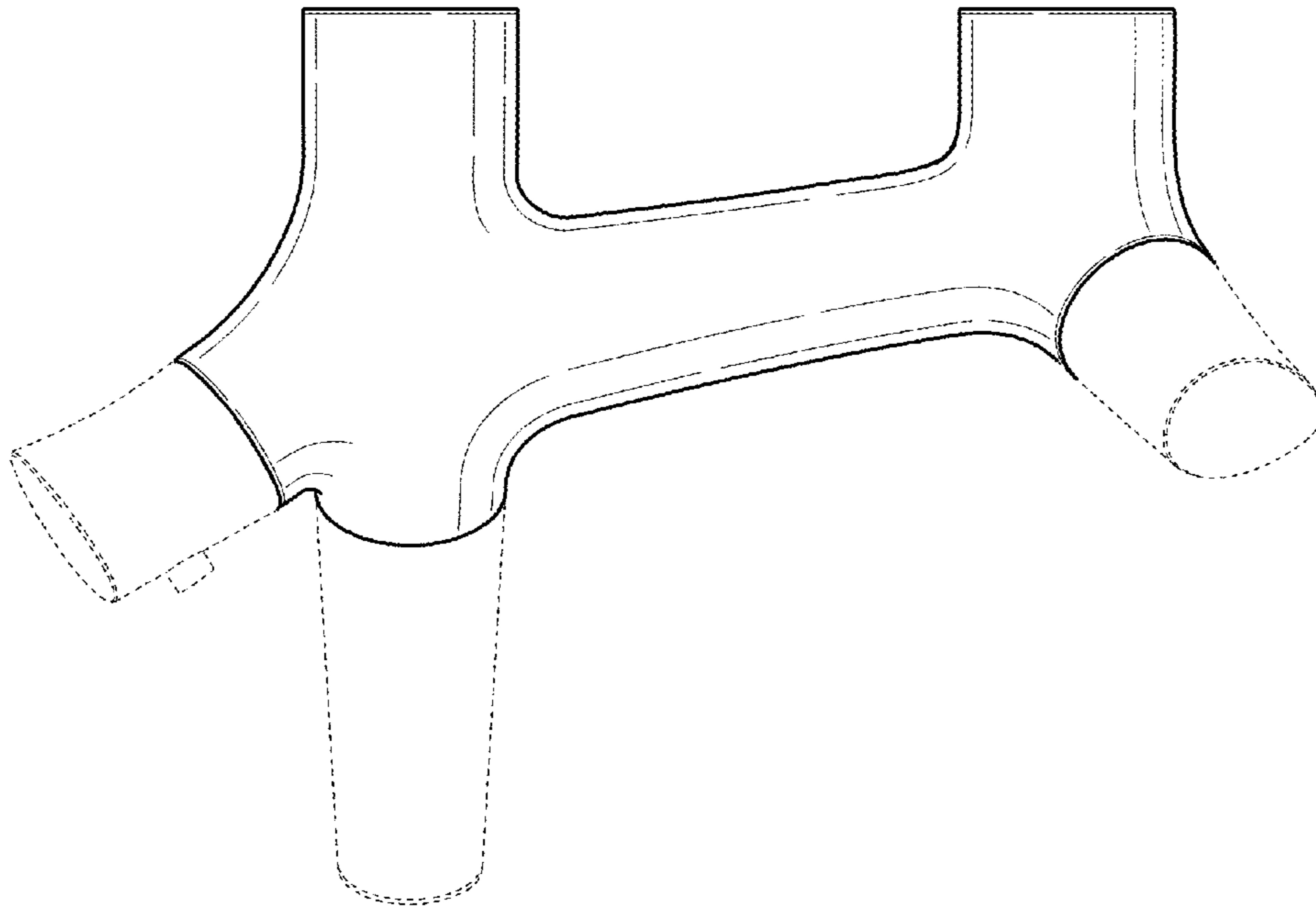

FIG. 7

