



US00D692498S

(12) **United States Design Patent**
Valls et al.

(10) **Patent No.:** **US D692,498 S**
(45) **Date of Patent:** **** Oct. 29, 2013**

- (54) **SWING BANNER FOR A TRAY**
- (71) Applicant: **IFCO Systems US, LLC**, Tampa, FL (US)
- (72) Inventors: **William H. Valls**, Loveland, OH (US);
Zachariah S. Simmering, Mansfield, OH (US)
- (73) Assignee: **IFCO Systems US, LLC**, Tampa, FL (US)
- (**) Term: **14 Years**
- (21) Appl. No.: **29/435,627**
- (22) Filed: **Oct. 25, 2012**
- (51) **LOC (9) Cl.** **20-03**
- (52) **U.S. Cl.**
USPC **D20/43**
- (58) **Field of Classification Search**
USPC D20/10, 19, 21, 39-44, 99; 40/642.01,
40/642.02, 649-651, 658, 591, 661,
40/661.03, 661.05-661.07
See application file for complete search history.

5,018,287	A	5/1991	Fast	
5,419,134	A *	5/1995	Gibson	40/611.05
D362,276	S *	9/1995	Murakami	D20/43
5,572,822	A	11/1996	Lynch et al.	
D376,821	S *	12/1996	Hathaway	D20/41
D384,979	S *	10/1997	Greene, Jr.	D20/41
6,293,405	B1	9/2001	Burch, Jr.	
6,389,723	B1 *	5/2002	Rink, Jr.	40/642.02
D487,781	S *	3/2004	Hunt	D20/42
7,131,224	B1	11/2006	Elliott et al.	
7,665,617	B2	2/2010	Shea	
7,874,088	B2	1/2011	Nikols	
D664,600	S *	7/2012	Clark et al.	D20/43
2006/0059756	A1	3/2006	Wells	
2011/0203150	A1 *	8/2011	Buncher	40/649

* cited by examiner

Primary Examiner — Mary Ann Calabrese
(74) *Attorney, Agent, or Firm* — Daniel A. Tallitsch; Baker & McKenzie LLP

(57) **CLAIM**
The ornamental design for a swing banner for a tray, as shown and described.

DESCRIPTION

FIG. 1 is a first perspective view showing my new design; FIG. 2 is a top elevational view thereof; FIG. 3 is a front elevational view thereof; FIG. 4 is a back elevational view thereof; FIG. 5 is a left elevational view thereof; FIG. 6 is a right elevational view thereof; FIG. 7 is a bottom elevational view thereof; and, FIG. 8 is a second perspective view showing my new design in its intended use. The broken lines are for illustrative purposes and form no part of the claimed design.

1 Claim, 7 Drawing Sheets

- (56) **References Cited**
U.S. PATENT DOCUMENTS
- | | | | | |
|-----------|-----|---------|--------------|--------|
| 1,285,890 | A | 11/1918 | Anderson | |
| 2,040,750 | A | 5/1936 | Long | |
| 2,779,114 | A | 1/1957 | Orthwine | |
| 2,816,377 | A * | 12/1957 | Hastings | 40/591 |
| 3,955,296 | A | 5/1976 | Kapstad | |
| 4,044,485 | A | 8/1977 | Hopp | |
| 4,372,066 | A | 2/1983 | Slavsky, Sr. | |
| 4,406,074 | A | 9/1983 | Gallimore | |
| 4,775,058 | A | 10/1988 | Yatsko | |
| 4,882,862 | A | 11/1989 | Slavsky, Sr. | |

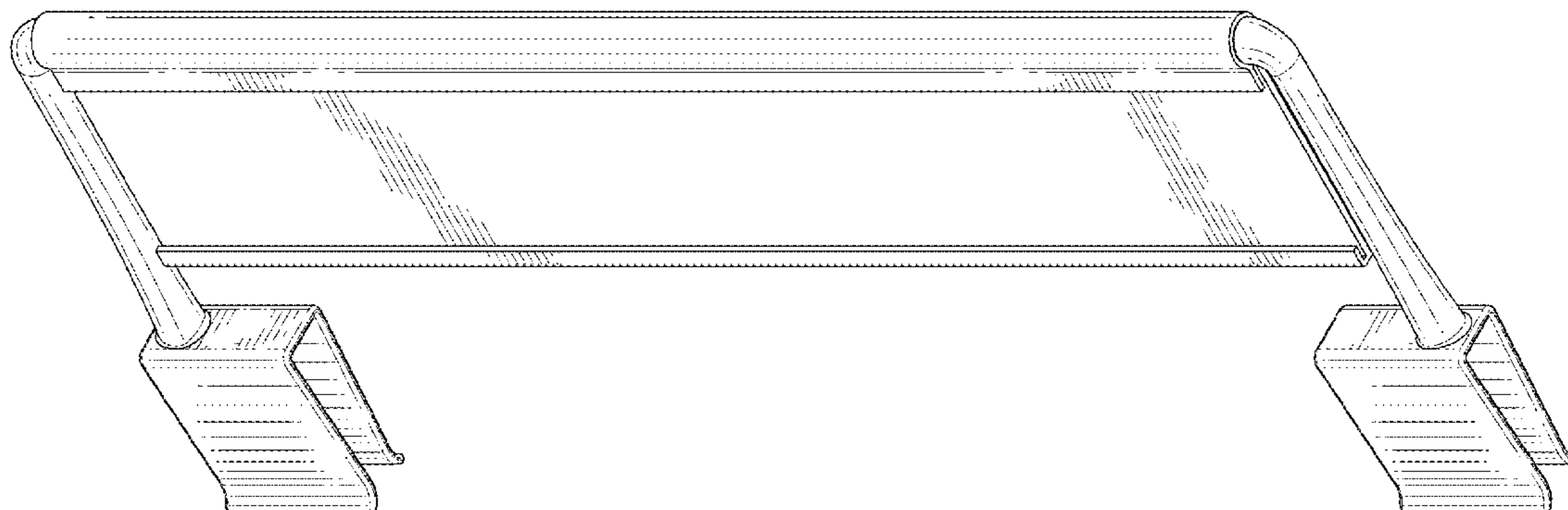



FIG. 1

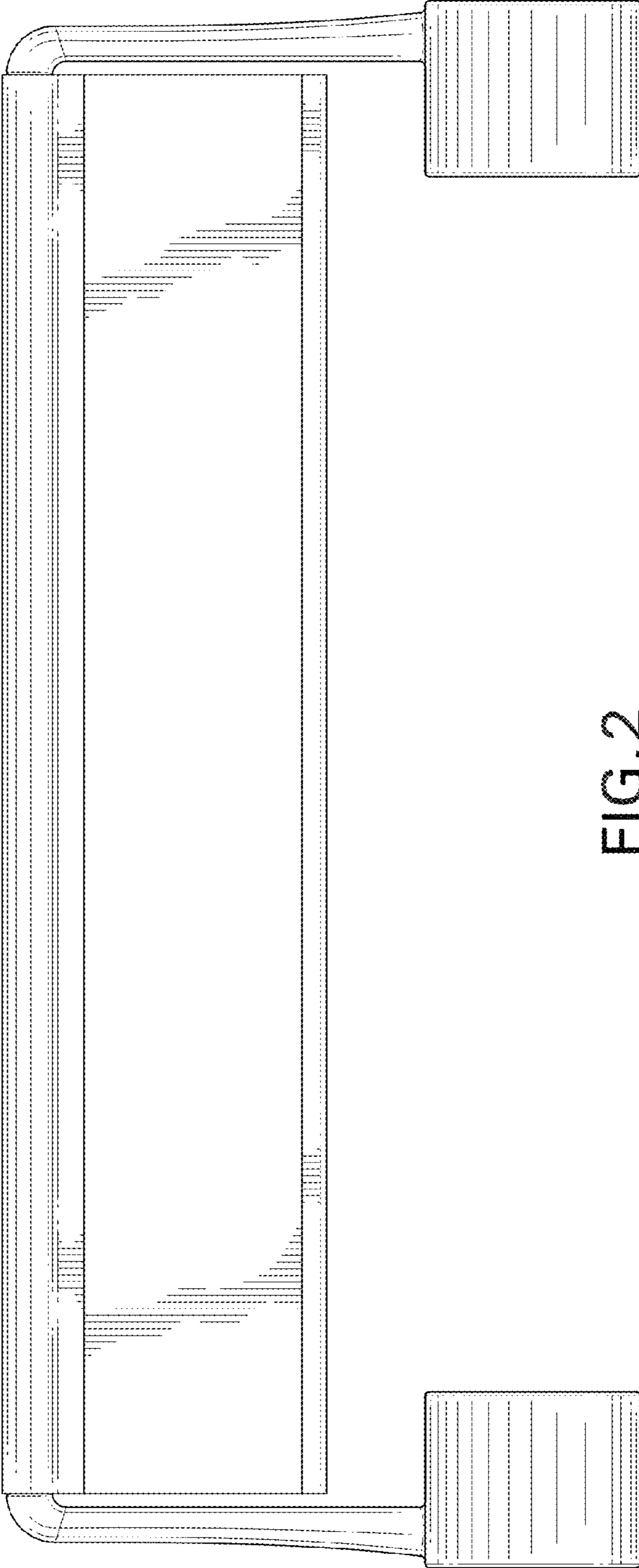

FIG.2

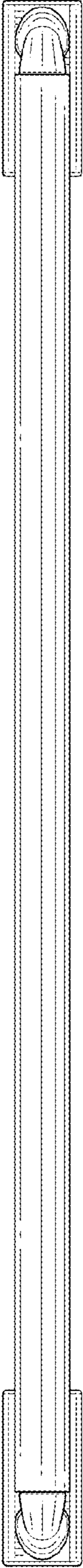

FIG. 3

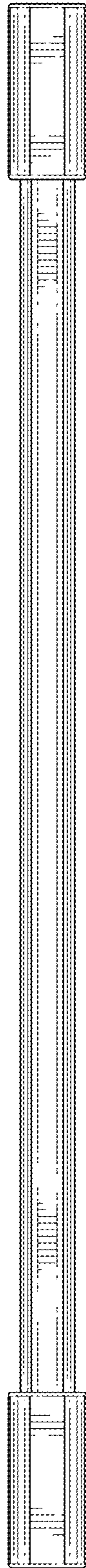

FIG. 4

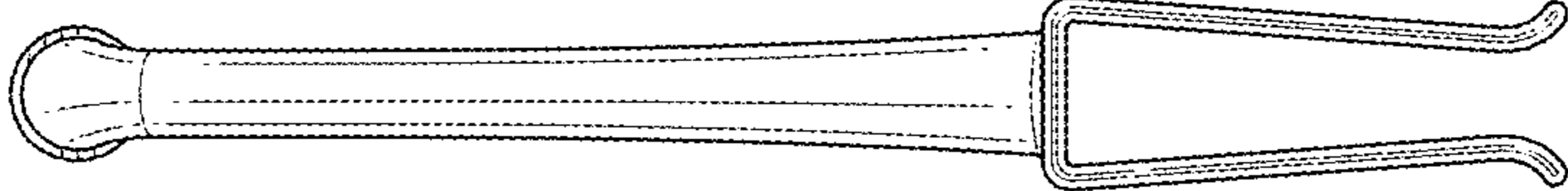

FIG. 6

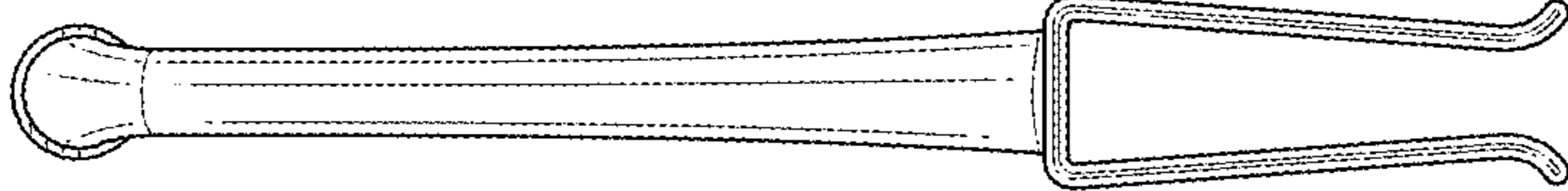

FIG. 5

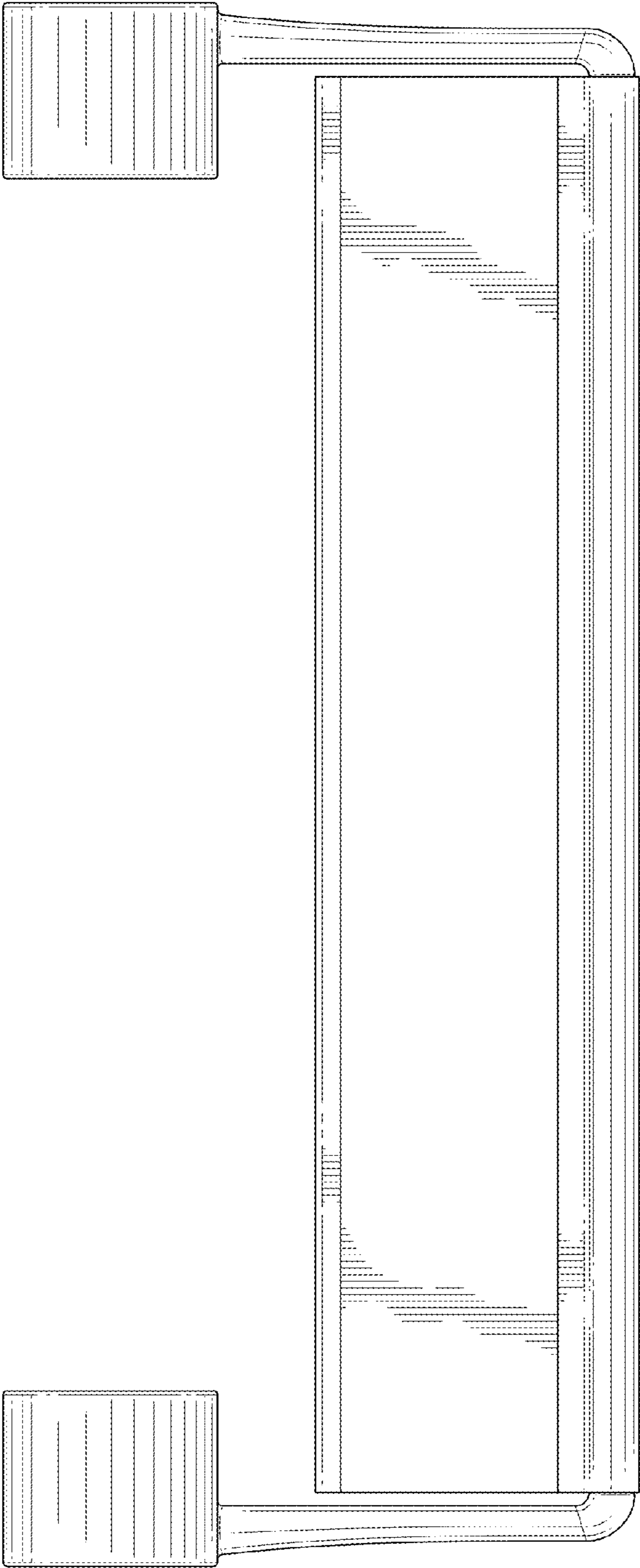

FIG. 7

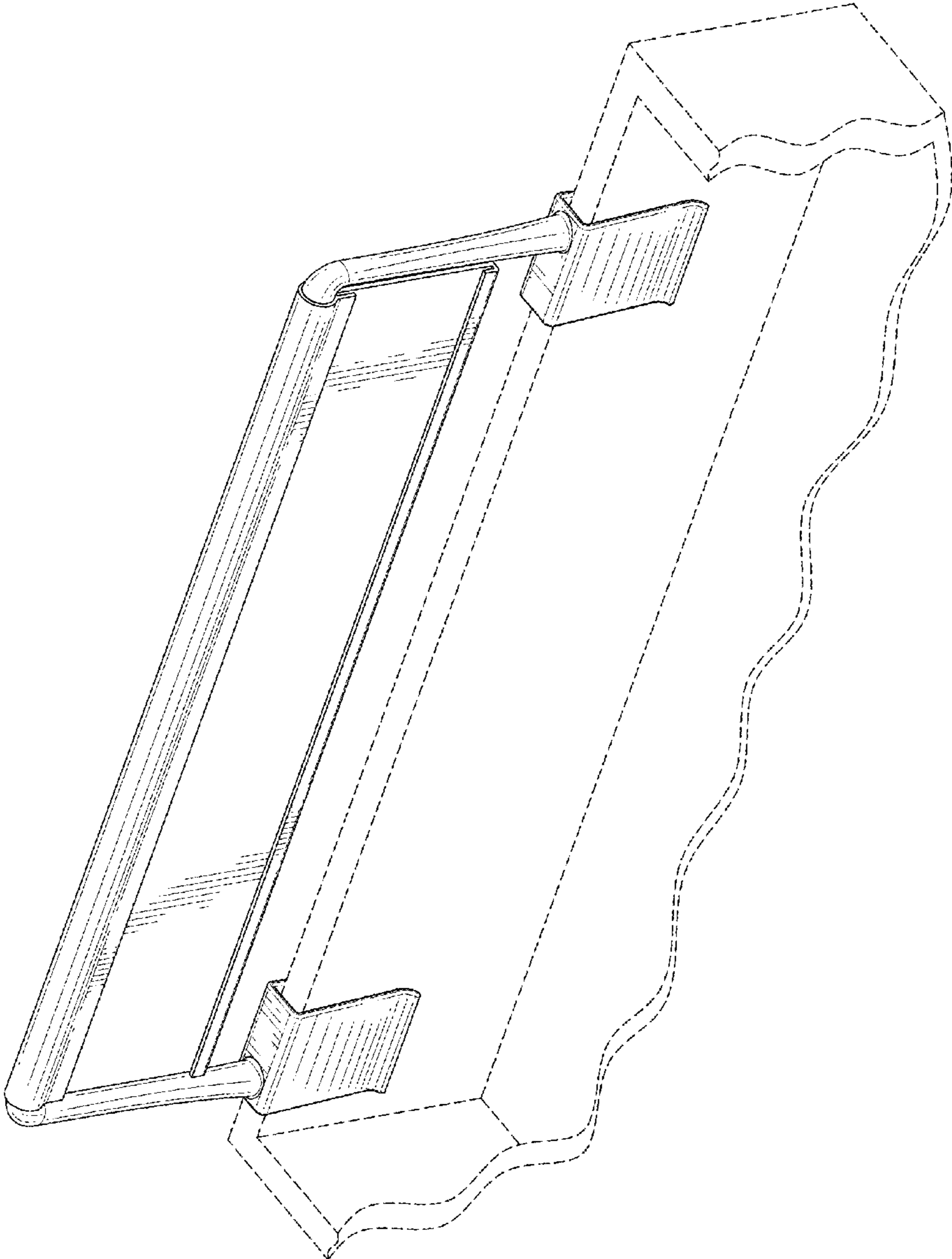

FIG.8