



US00D692485S

(12) **United States Design Patent**
Newson

(10) **Patent No.:** **US D692,485 S**

(45) **Date of Patent:** **** Oct. 29, 2013**

(54) **PEN**

(75) Inventor: **Marc Newson**, London (GB)

(73) Assignee: **Hermes Sellier (Societe par Actions Simplifiee)**, Paris (FR)

(**) Term: **14 Years**

(21) Appl. No.: **29/423,409**

(22) Filed: **May 31, 2012**

(30) **Foreign Application Priority Data**

Dec. 2, 2011 (WO) DM/077 237

(51) **LOC (9) Cl.** **19-06**

(52) **U.S. Cl.**
USPC **D19/51**

(58) **Field of Classification Search**
USPC D14/411; D19/35, 36, 41-51, 53-58;
24/11 F, 11 P, 11 R; 401/52, 99-109,
401/192, 195, 196

See application file for complete search history.

(56) **References Cited**

U.S. PATENT DOCUMENTS

D116,098 S *	8/1939	Parker	D19/51
D146,806 S *	5/1947	Moholy-Nagy	D19/51
2,608,953 A *	9/1952	Kollsman	401/35
2,669,223 A *	2/1954	Miessner	401/183
2,669,224 A *	2/1954	Miessner	15/447
D178,033 S *	6/1956	Young et al.	D19/51
D472,240 S *	3/2003	Seog	D14/411
D500,790 S *	1/2005	Jaakkola	D19/43
D589,556 S *	3/2009	Keda	D19/45
D641,409 S *	7/2011	Wang et al.	D19/50

D647,964 S *	11/2011	Wang et al.	D19/50
D667,828 S *	9/2012	Park	D14/411
D669,128 S *	10/2012	Zhang	D19/50

* cited by examiner

Primary Examiner — Elizabeth Albert

(74) *Attorney, Agent, or Firm* — Foley & Lardner LLP

(57) **CLAIM**

I claim the ornamental design for a pen, as shown and described.

DESCRIPTION

FIG. 1 is a front elevation view of a pen showing my new design with the nib retracted;

FIG. 2 is a rear elevation view of FIG. 1;

FIG. 3 is a right side elevation view of FIG. 1;

FIG. 4 is a left side elevation view of FIG. 1;

FIG. 5 is a top plan view of FIG. 1;

FIG. 6 is a bottom plan view of FIG. 1;

FIG. 7 is a front, bottom perspective view of FIG. 1;

FIG. 8 is a front, top perspective view of FIG. 1;

FIG. 9 is a front elevation view of FIG. 1 with the nib extended;

FIG. 10 is a rear elevation view of FIG. 9;

FIG. 11 is a right side elevation view of FIG. 9;

FIG. 12 is a left side elevation view of FIG. 9;

FIG. 13 is a top plan view of FIG. 9;

FIG. 14 is a bottom plan view of FIG. 9;

FIG. 15 is a front, bottom perspective view of FIG. 9; and,

FIG. 16 is an enlarged perspective detail view of a portion of FIG. 15.

The broken lines in FIGS. 15 and 16 are included for the purpose of identifying the detail view and form no part of the claimed design.

1 Claim, 14 Drawing Sheets

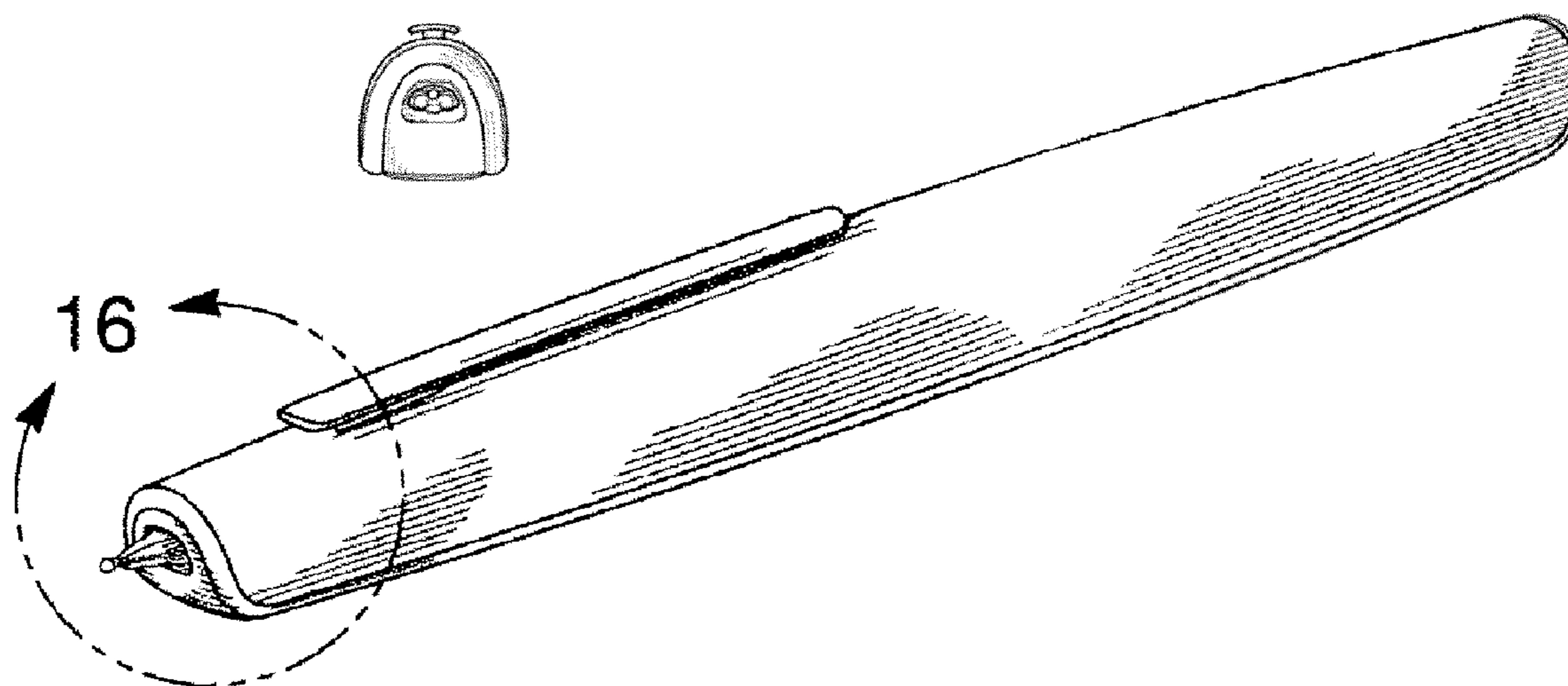



Fig. 1

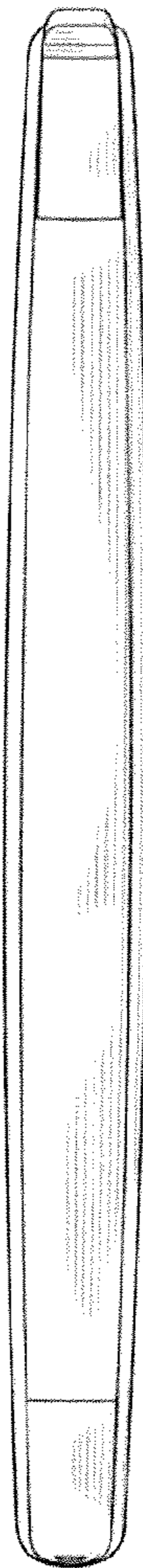

Fig. 2

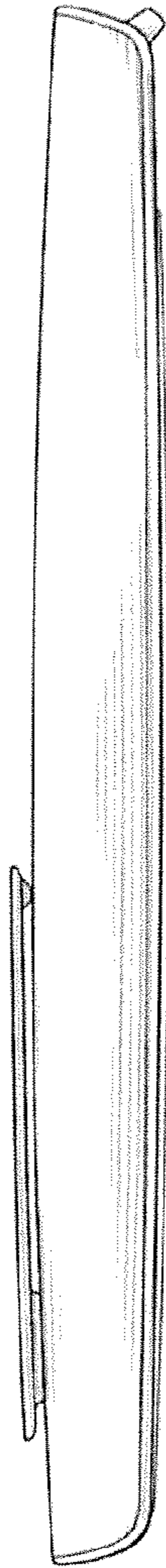

Fig. 3

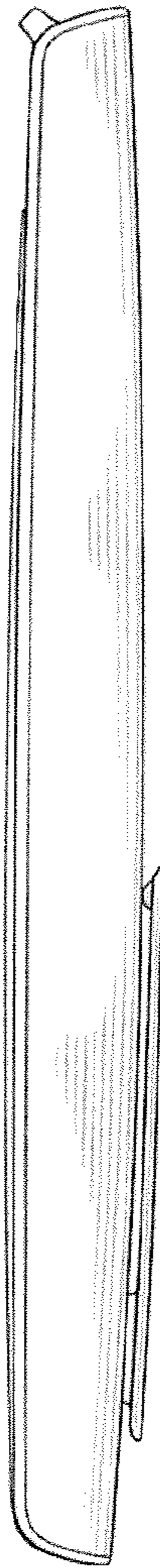

Fig. 4

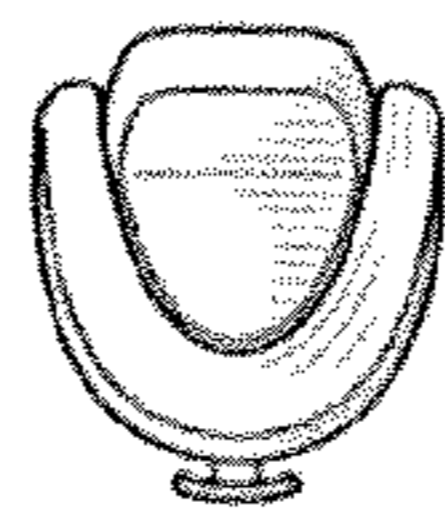

Fig. 5



Fig. 6

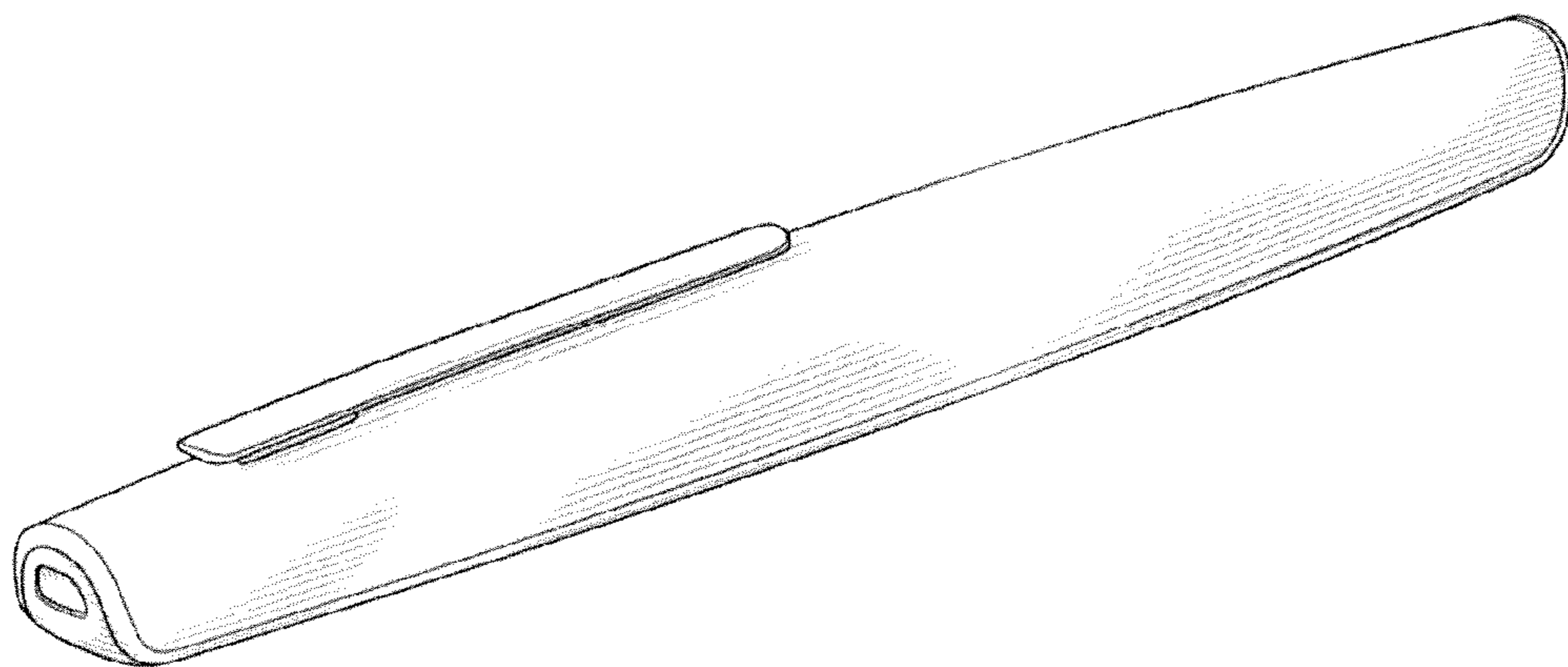

Fig. 7

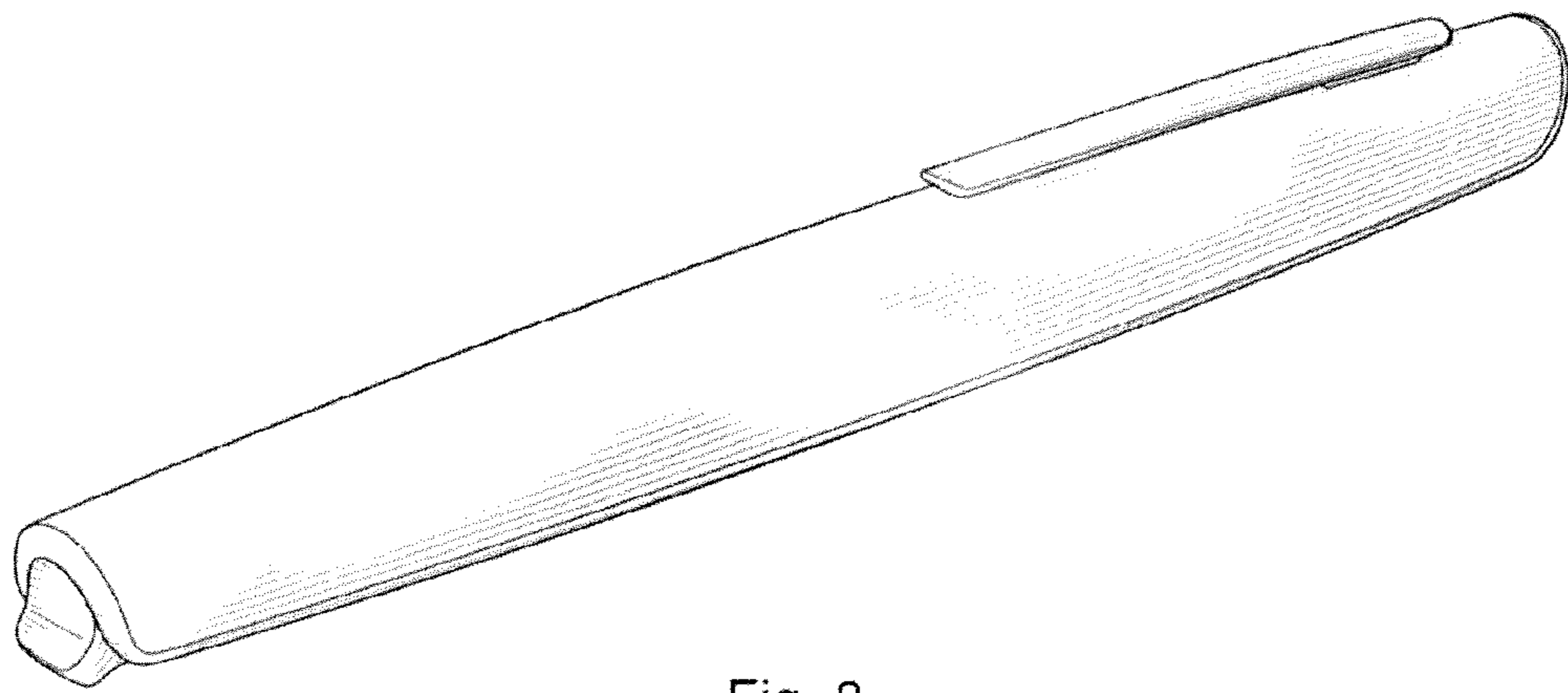

Fig. 8

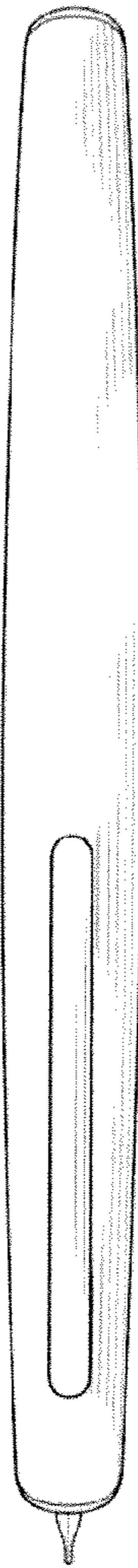

Fig. 9

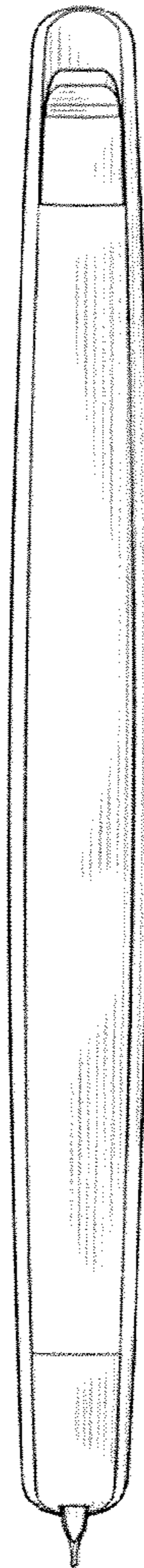

Fig. 10

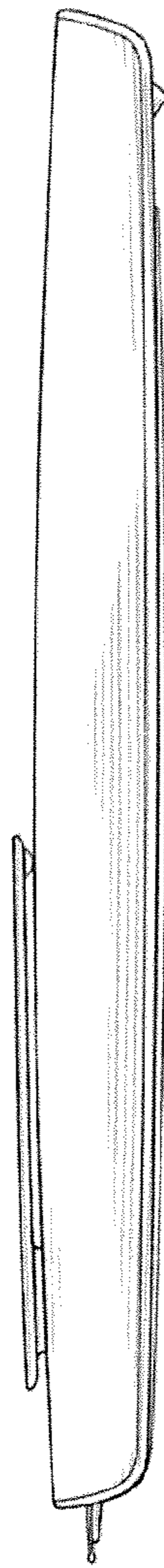

Fig. 11

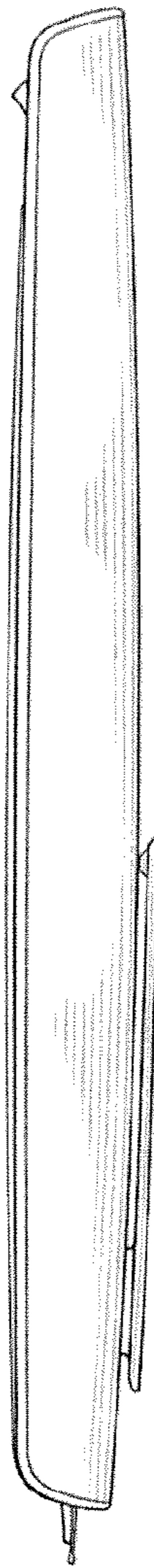

Fig. 12



Fig. 13

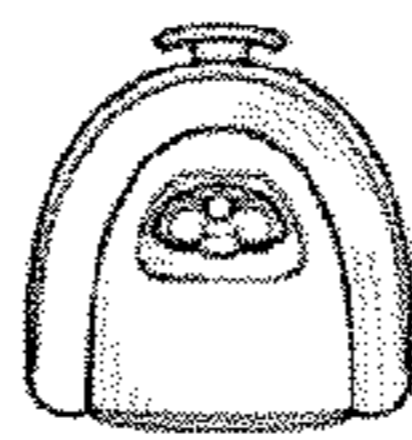

Fig. 14

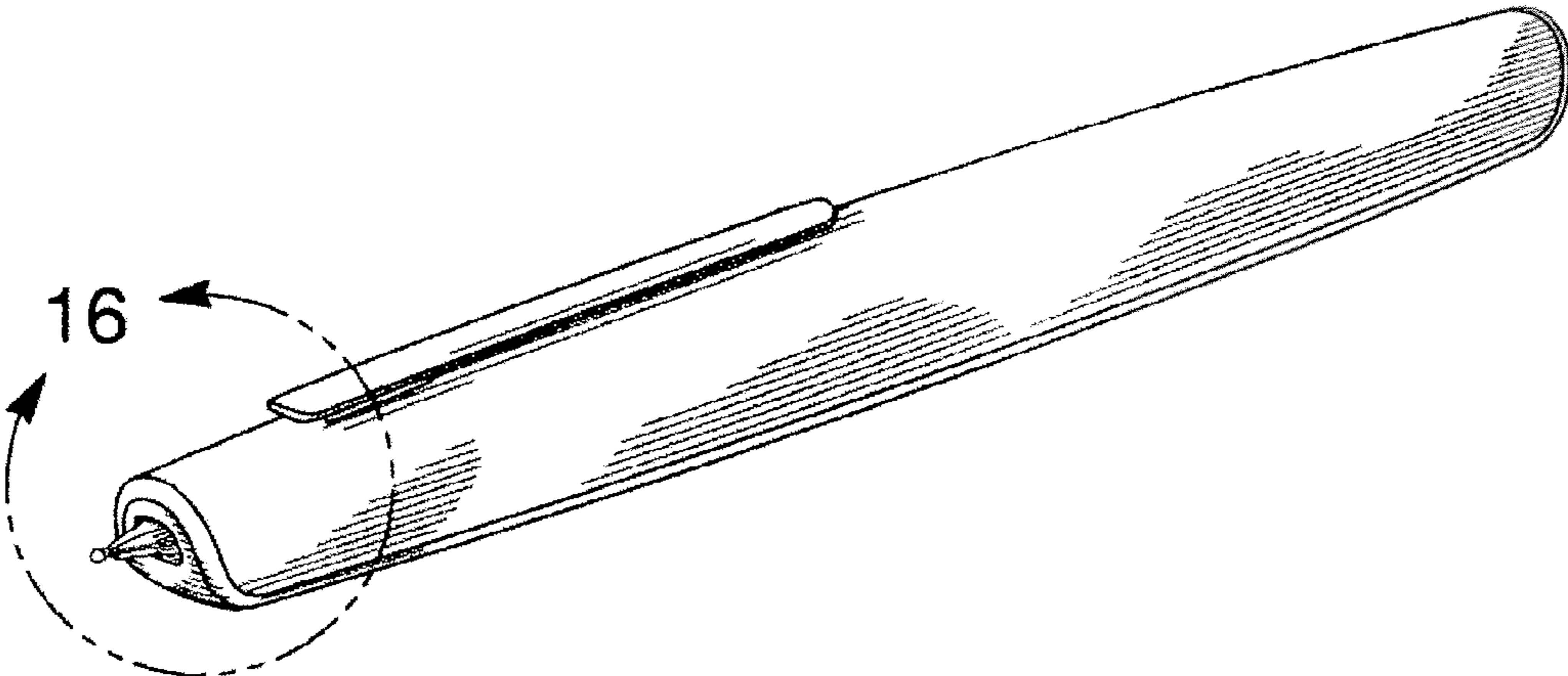

Fig. 15

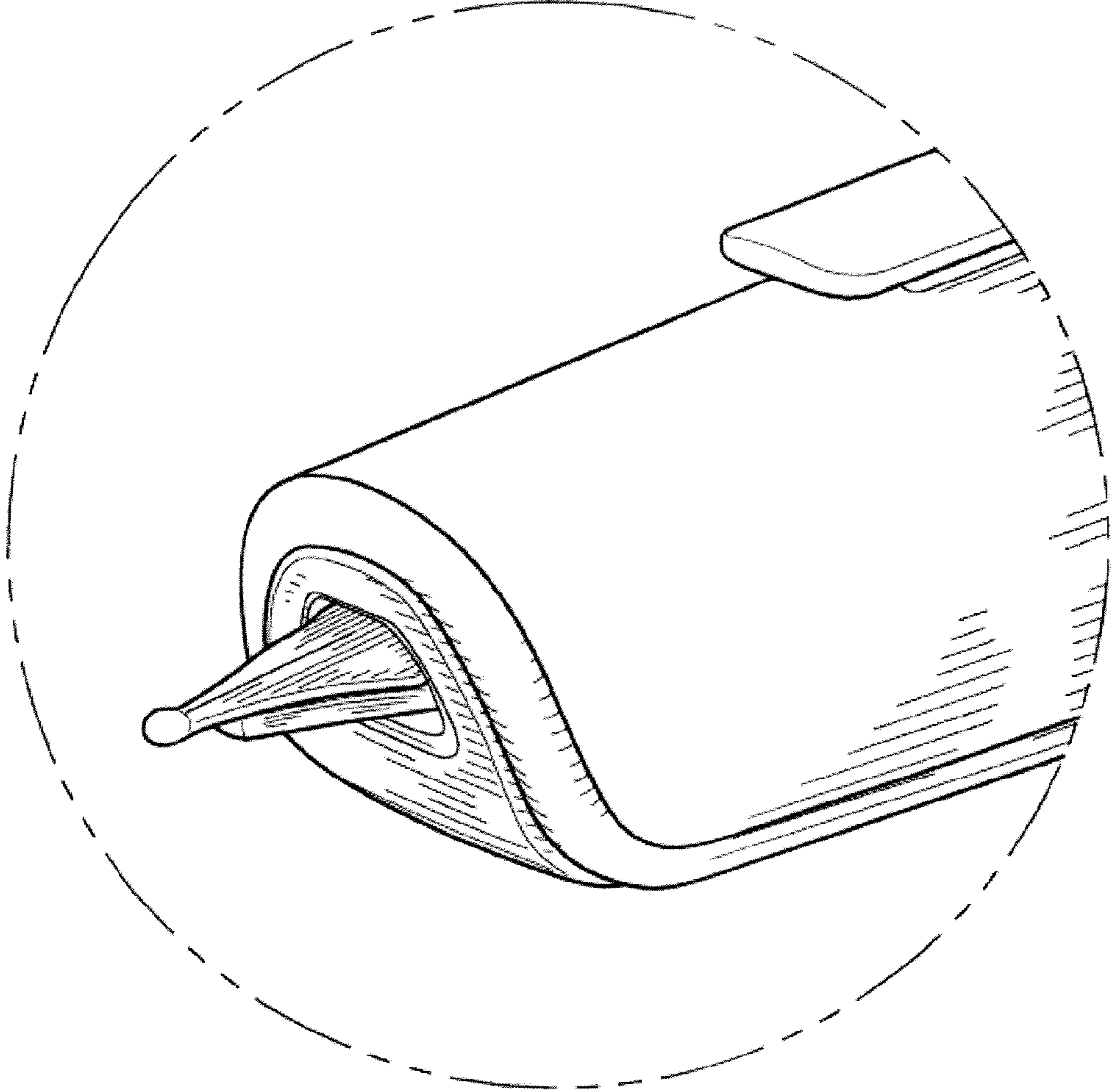

Fig. 16