

US00D692391S

(12) **United States Design Patent**
Kim

(10) **Patent No.:** **US D692,391 S**
(45) **Date of Patent:** **** Oct. 29, 2013**

(54) **O-RING**
(75) Inventor: **Jin-Kwang Kim**, Kyung-Nam (KR)
(73) Assignee: **Tyco Electronics Amp Korea Ltd.**,
Kyungsangbuk-Do (KR)
(**) Term: **14 Years**
(21) Appl. No.: **29/399,840**

D643,912 S * 8/2011 Bowman et al. D23/269
D646,764 S * 10/2011 Rusconi D23/269
D655,797 S * 3/2012 Muramatsu D23/269

FOREIGN PATENT DOCUMENTS

JP D1333539 C 8/1986
JP D1394393 C 8/1987
JP D1397981 C 9/1987
JP D1448949 A 6/1989

OTHER PUBLICATIONS

Abstract of JP 1148949 (A), Method and Apparatus For Reproducing
Rough Particle Region of Neck Part of Bonding Wire, published Jun.
12, 1989, Applicant Nippon Steel Corp, 2 pages.
Abstract of JP 1333539 (C), Casting Method of Gas Turbine Blade,
published Aug. 28, 1986, Applicant Hitachi LTD, 1 page.

* cited by examiner

Primary Examiner — Daniel Bui
(74) *Attorney, Agent, or Firm* — Barley Snyder

(57) **CLAIM**
The ornamental design for an O-ring, as shown and described.

DESCRIPTION

FIG. 1 is a top perspective view of an O-ring, showing my new
design;
FIG. 2 is a front elevation view thereof;
FIG. 3 is a rear elevation view thereof;
FIG. 4 is a left side elevation view thereof;
FIG. 5 is a right side elevation view thereof;
FIG. 6 is a top plan view thereof;
FIG. 7 is a bottom plan view thereof; and,
FIG. 8 is a cross sectional view thereof taken along the line
8-8 of FIG. 6.

1 Claim, 8 Drawing Sheets

(22) Filed: **Aug. 19, 2011**
(30) **Foreign Application Priority Data**
Feb. 21, 2011 (KR) 30-2011-0006799
(51) **LOC (9) Cl.** **13-03**
(52) **U.S. Cl.**
USPC **D13/154**; D23/269
(58) **Field of Classification Search**
USPC D13/133, 147, 148, 154, 184, 199;
D23/259, 262, 269; 174/31.5, 50.52,
174/59, 60, 64, 520, 539, 554, 650;
277/301, 304, 310-311, 351, 902-935;
439/180, 246, 252, 278, 374, 378, 379,
439/380, 381, 527, 530, 533, 892, 894
See application file for complete search history.

(56) **References Cited**
U.S. PATENT DOCUMENTS
D196,724 S * 10/1963 Davis, Jr. D24/129
D243,406 S * 2/1977 Mooney et al. D13/154
D289,078 S * 3/1987 Vassallo et al. D23/269
D558,310 S * 12/2007 Quesada D23/269
D633,991 S * 3/2011 Nakagawa D23/269

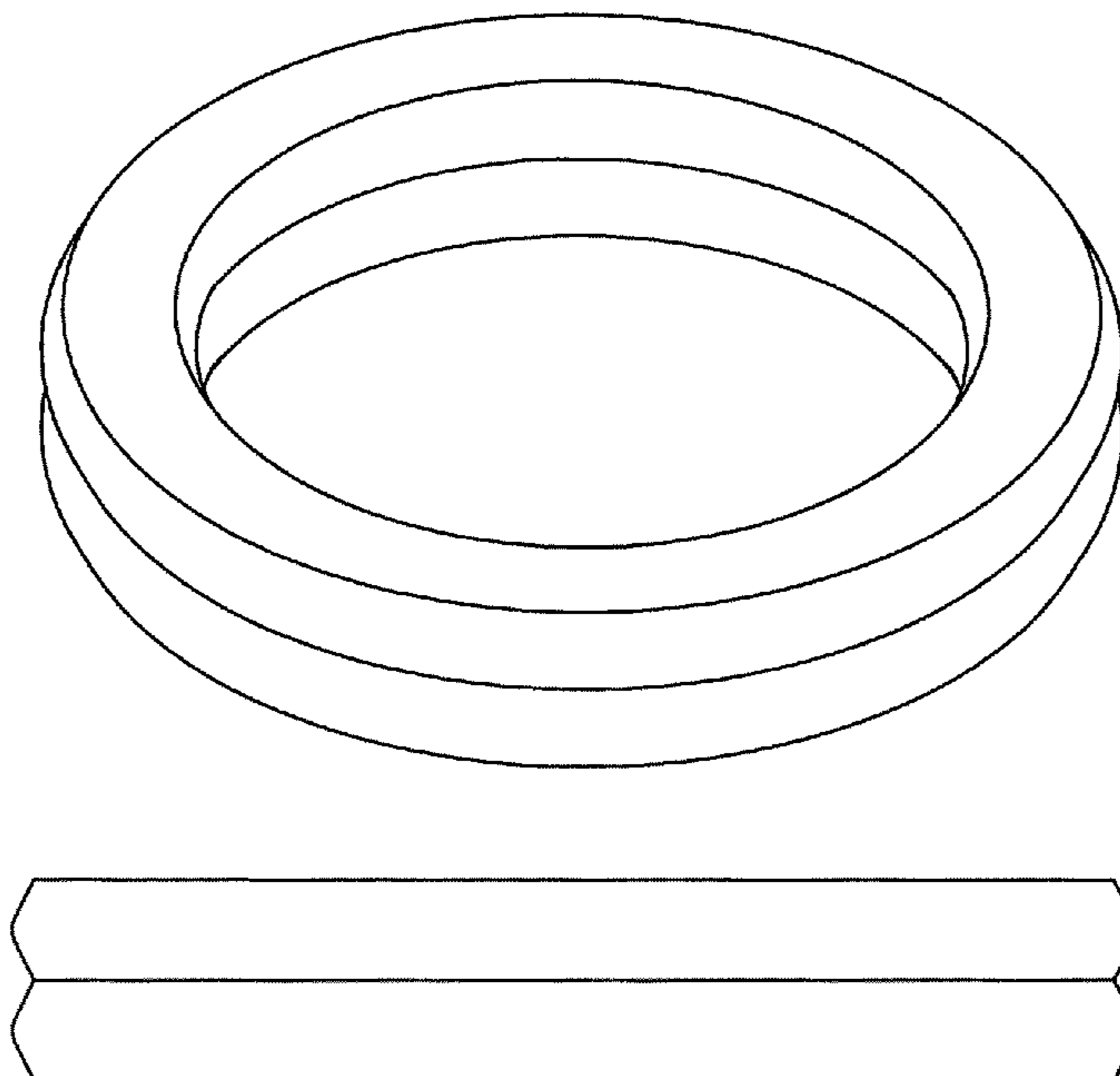

Fig. 1

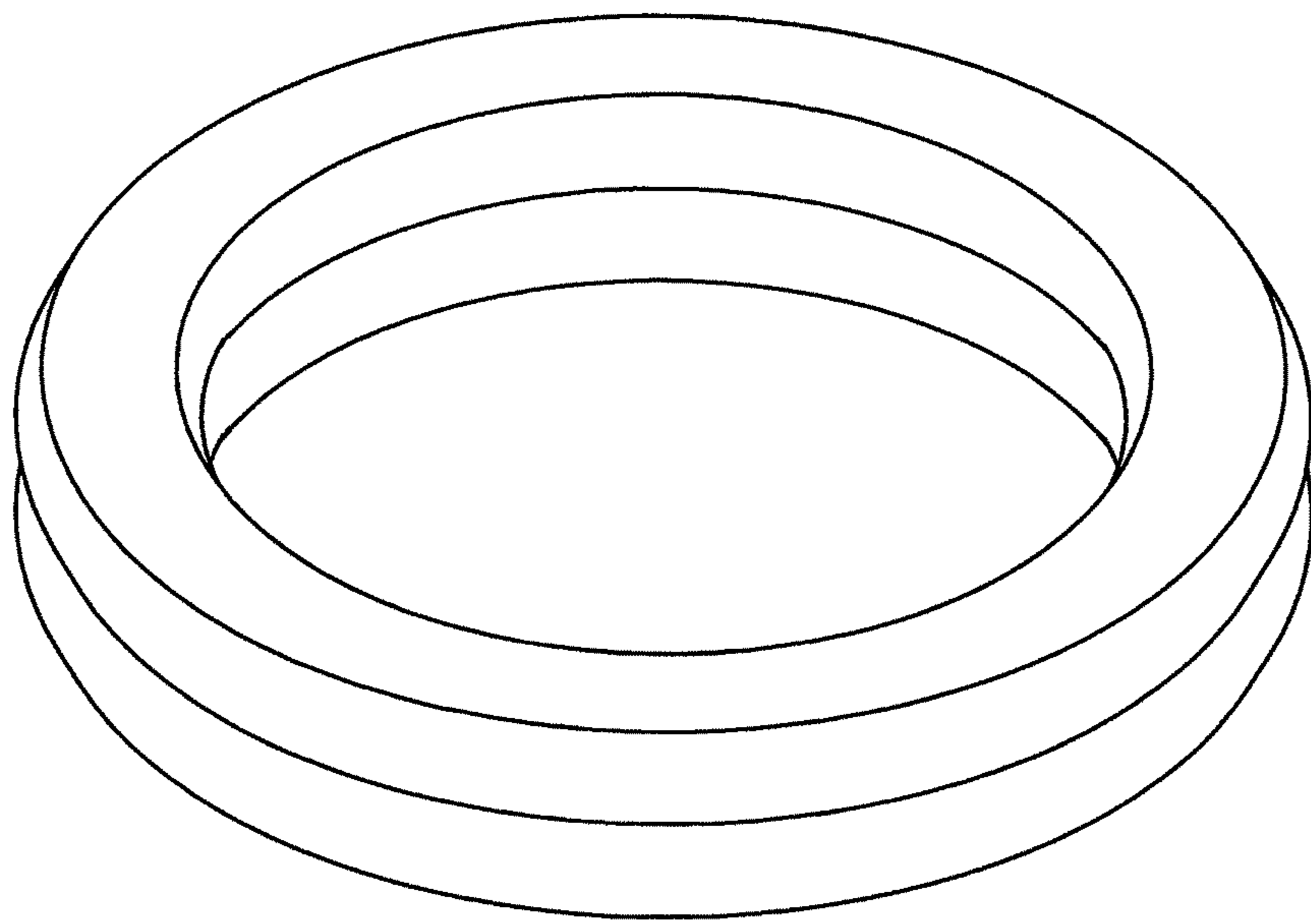

Fig. 2

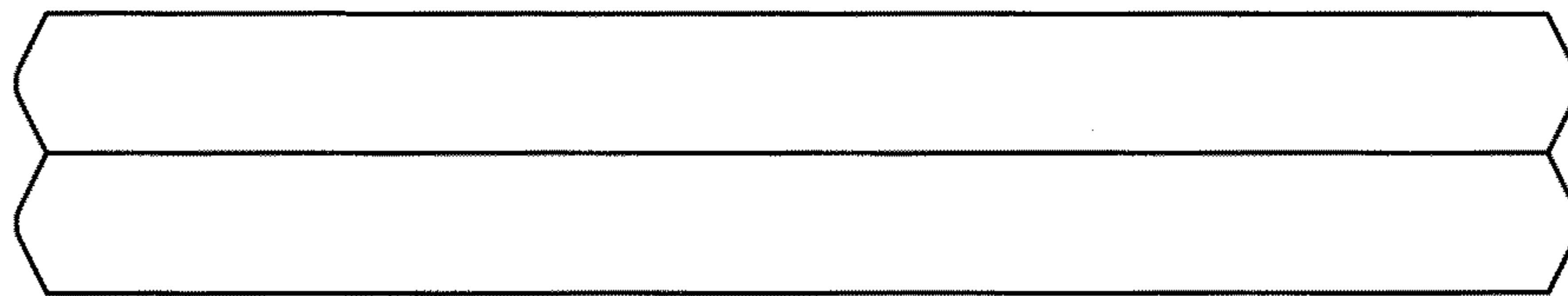

Fig. 3

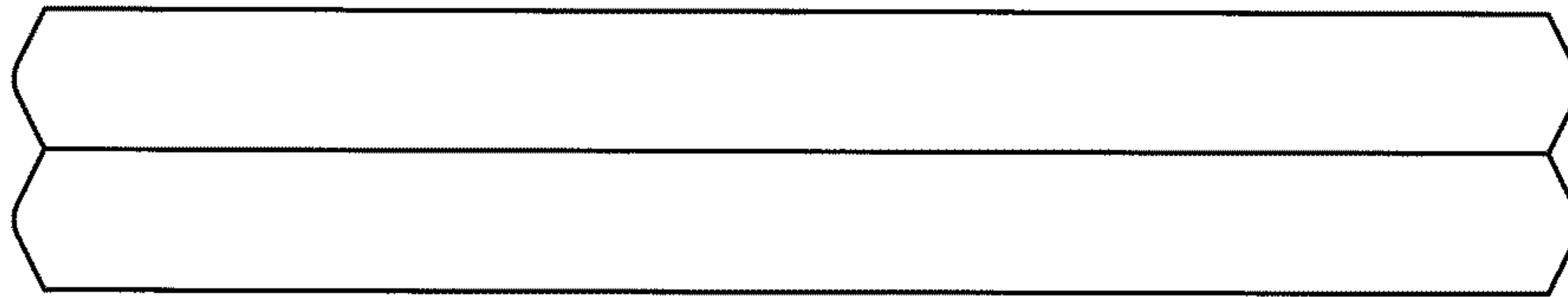

Fig. 4

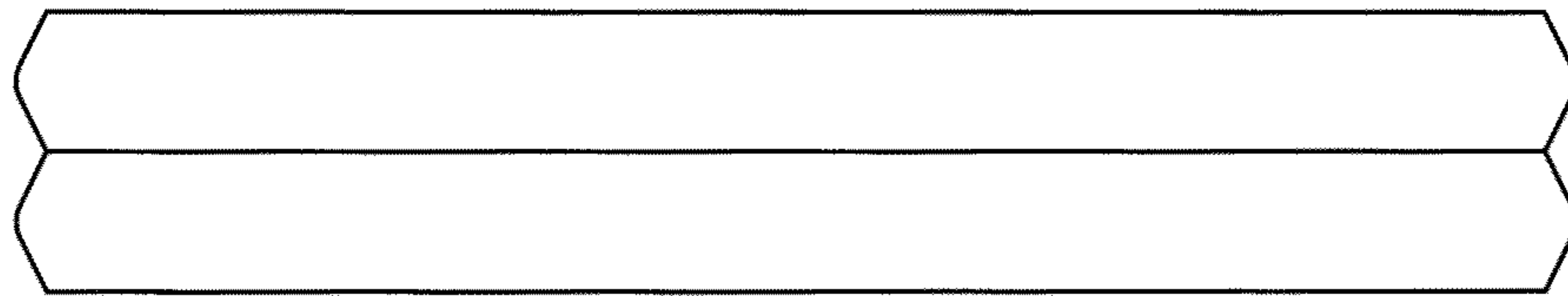

Fig. 5

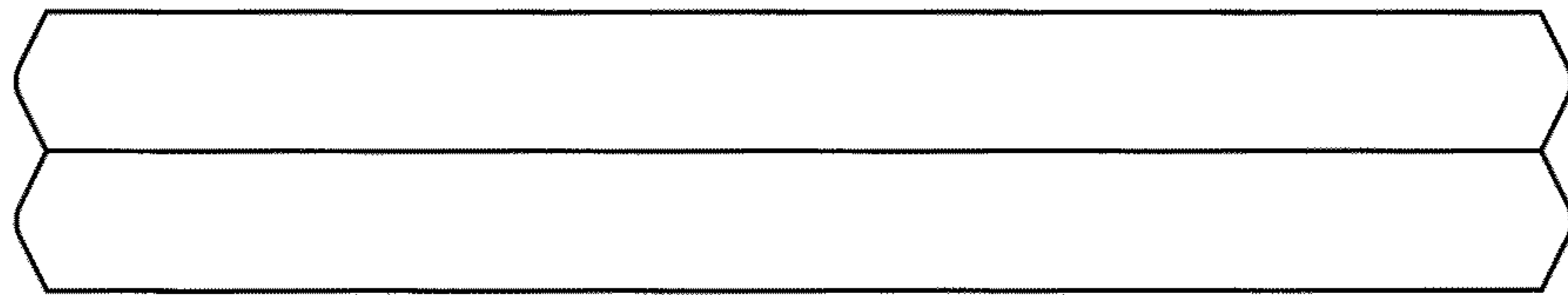

Fig. 6

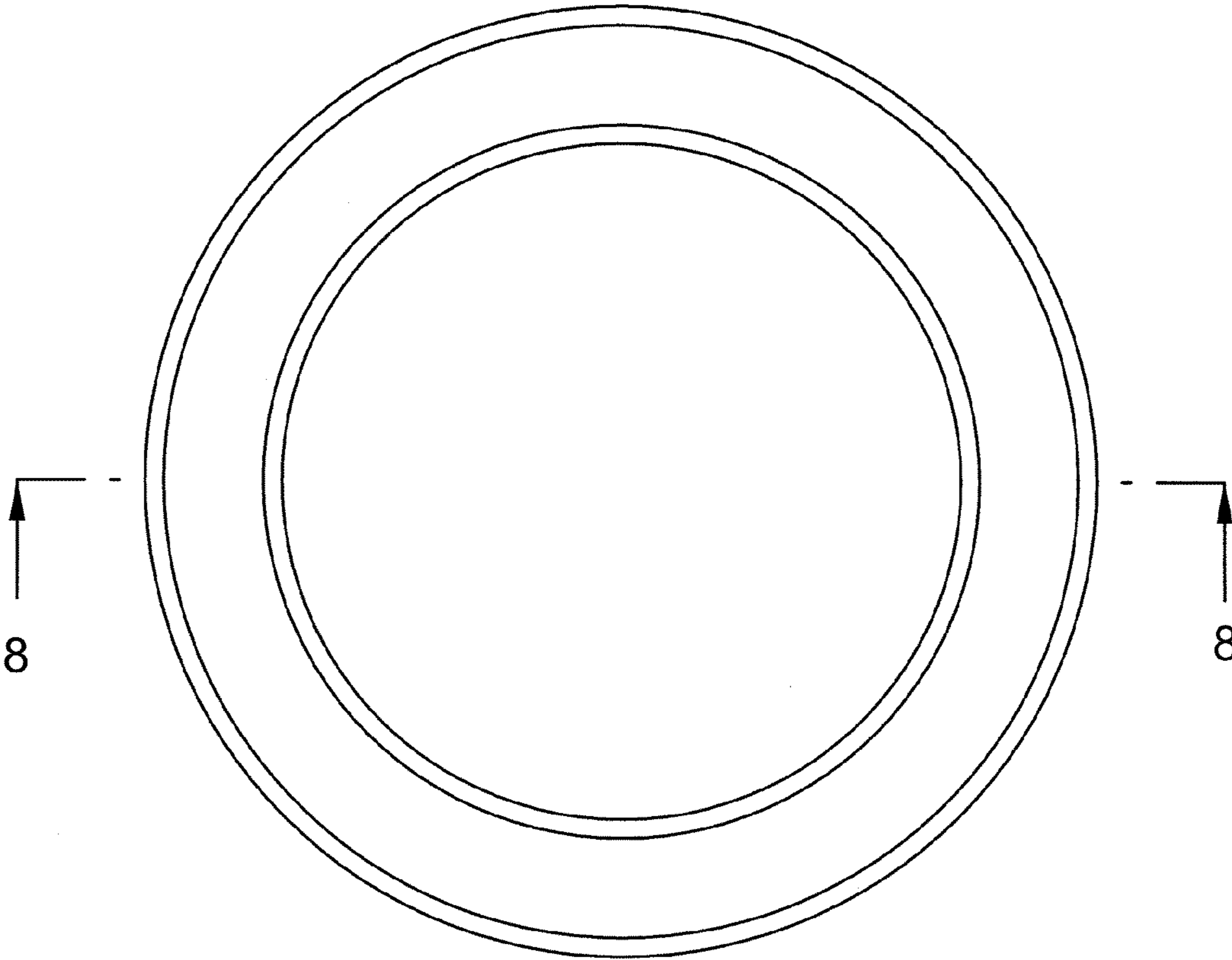

Fig. 7

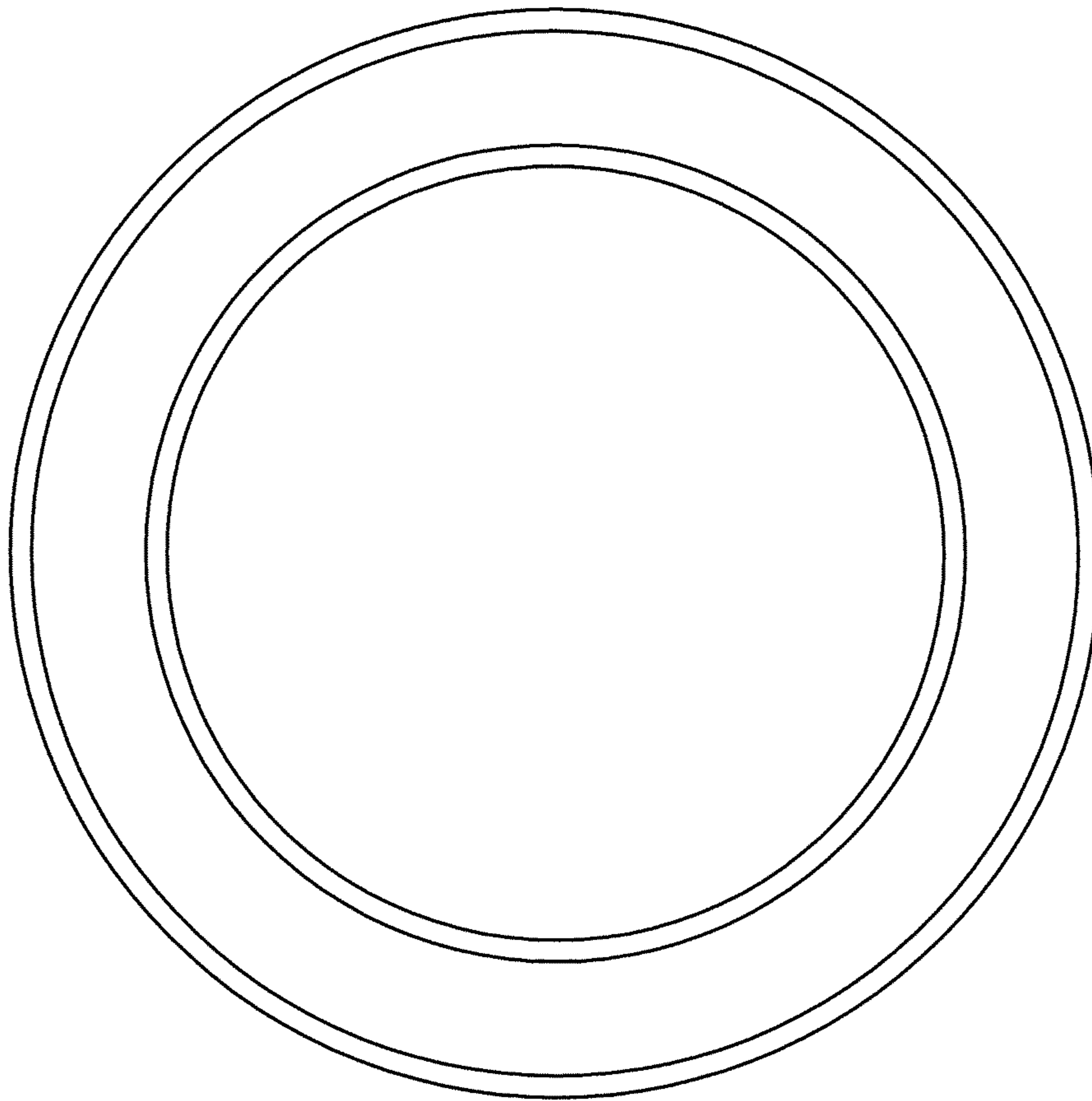

Fig. 8

