



US00D692282S

(12) **United States Design Patent**
George

(10) **Patent No.:** **US D692,282 S**

(45) **Date of Patent:** **** Oct. 29, 2013**

(54) **FOOD CONTAINER**

(75) Inventor: **Sarah Danger George**, Vashon, WA
(US)

(73) Assignee: **Pacific Market International, LLC**,
Seattle, WA (US)

(**) Term: **14 Years**

(21) Appl. No.: **29/430,526**

(22) Filed: **Aug. 27, 2012**

(51) **LOC (9) Cl.** **07-07**

(52) **U.S. Cl.**

USPC **D7/629**

(58) **Field of Classification Search**

USPC D7/629, 601, 602, 630, 538-542;
D3/201-203.8, 273, 274;
220/780-806, 675, 236, 326, 324,
220/4.23-4.25

See application file for complete search history.

(56) **References Cited**

U.S. PATENT DOCUMENTS

D369,282 S *	4/1996	Arduini	D7/629
D452,374 S *	12/2001	Kim	D3/302
D481,910 S *	11/2003	Kim	D7/629
D483,622 S *	12/2003	Kim	D7/629
D493,073 S *	7/2004	Kim	D7/629
6,793,096 B1 *	9/2004	Seok	220/788
D517,311 S *	3/2006	Kim	D3/218

D544,762 S *	6/2007	Zimmerman	D7/629
D562,083 S *	2/2008	Lown et al.	D7/629
D617,151 S *	6/2010	Olivari	D7/629

* cited by examiner

Primary Examiner — Terry Wallace

(74) *Attorney, Agent, or Firm* — Davis Wright Tremaine
LLP; George C. Rondeau, Jr.

(57) **CLAIM**

The ornamental design for a food container, as shown and
described.

DESCRIPTION

FIG. 1 is a top left side perspective view of a food container
showing my new design.

FIG. 2 is a top plan view thereof.

FIG. 3 is a left side elevational view thereof.

FIG. 4 is a front elevational view thereof.

FIG. 5 is a right side elevational view thereof.

FIG. 6 is a rear elevational view thereof.

FIG. 7 is a bottom plan view thereof.

FIG. 8 is a top left side perspective view of a second embodi-
ment thereof.

FIG. 9 is a top plan view thereof.

FIG. 10 is a left side elevational view thereof.

FIG. 11 is a front elevational view thereof.

FIG. 12 is a right side elevational view thereof.

FIG. 13 is a rear elevational view thereof; and,

FIG. 14 is a bottom plan view thereof.

The broken lines represent portions of the food container that
form no part of the claim.

1 Claim, 14 Drawing Sheets

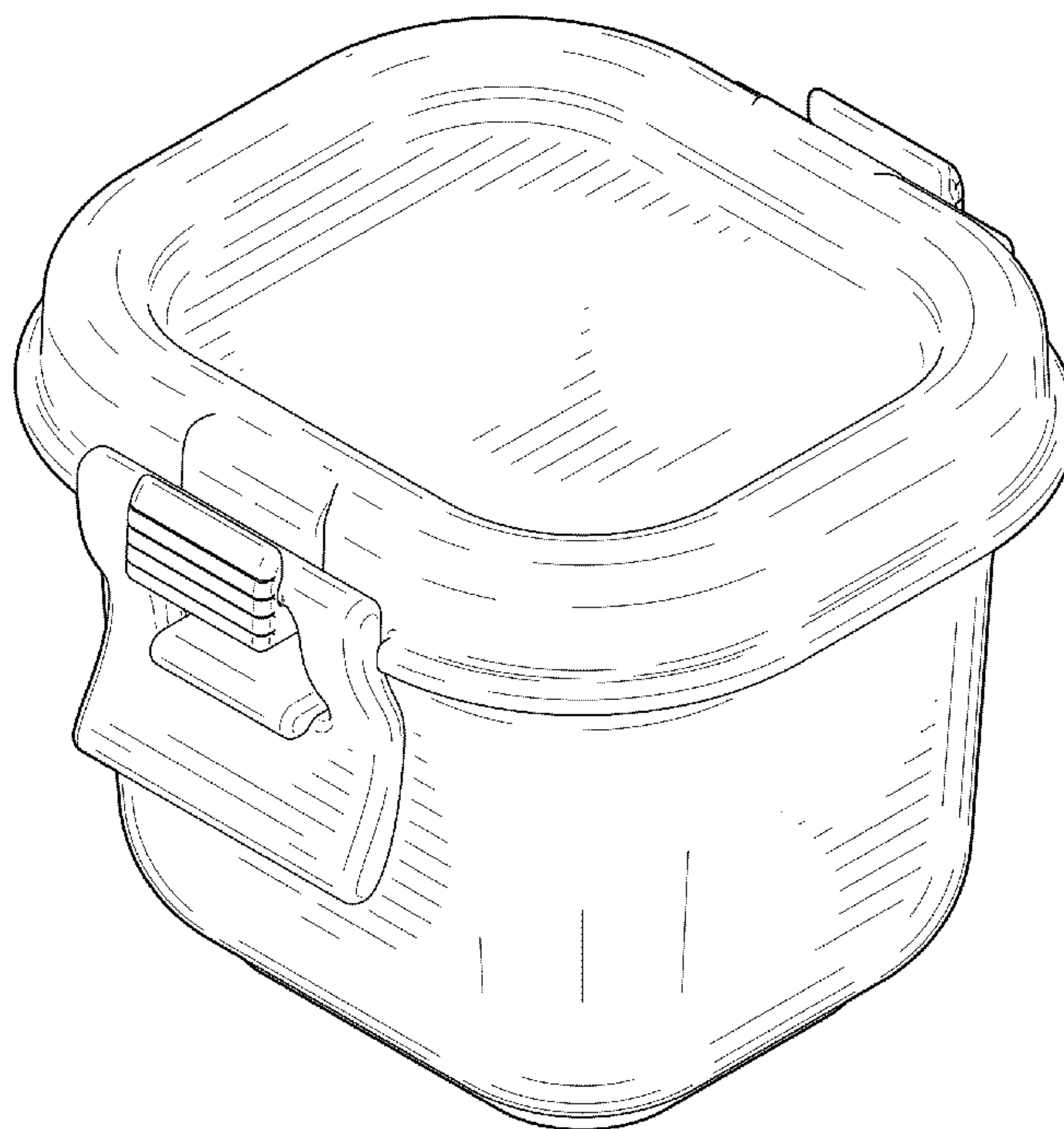

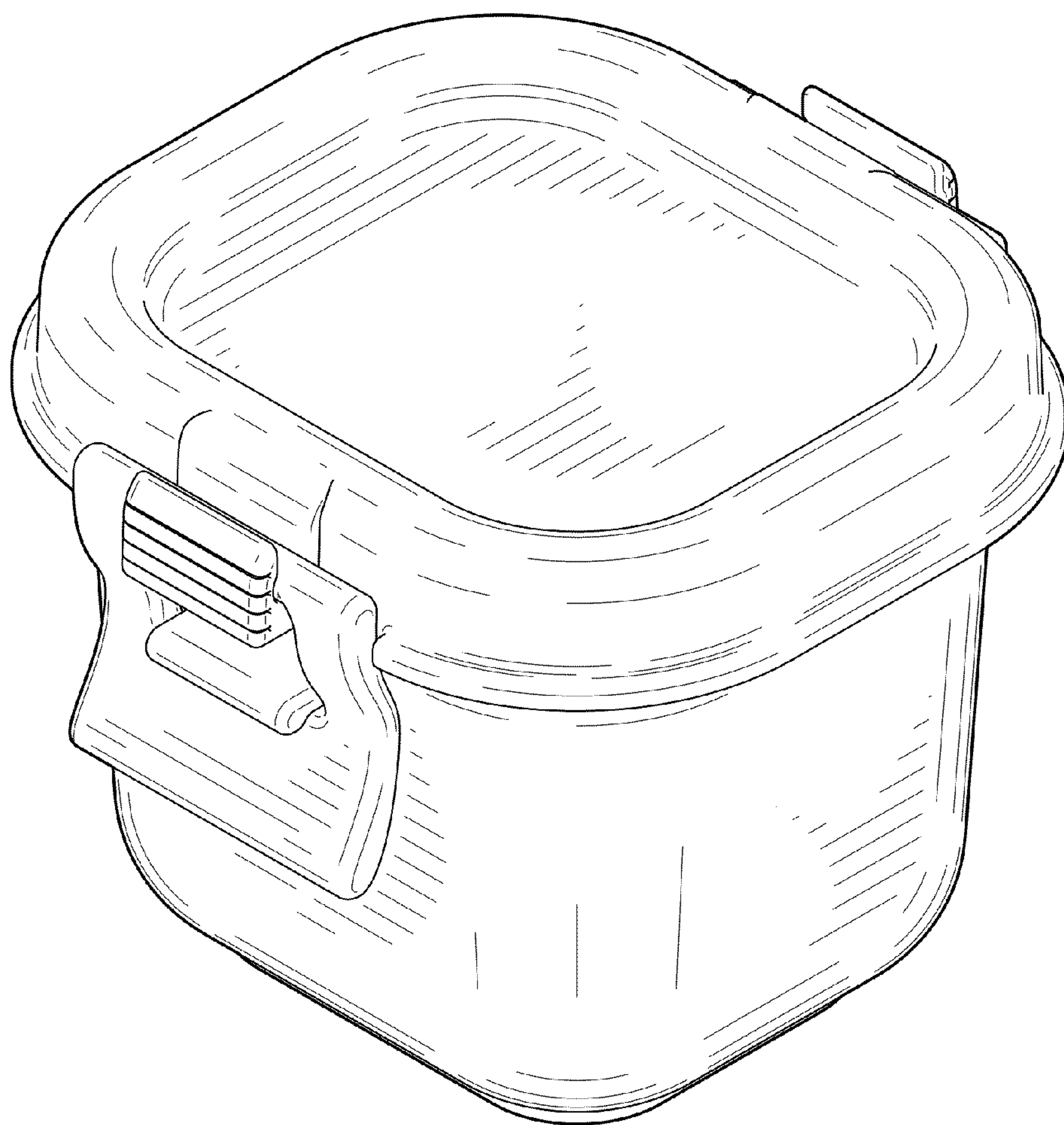

FIG.1

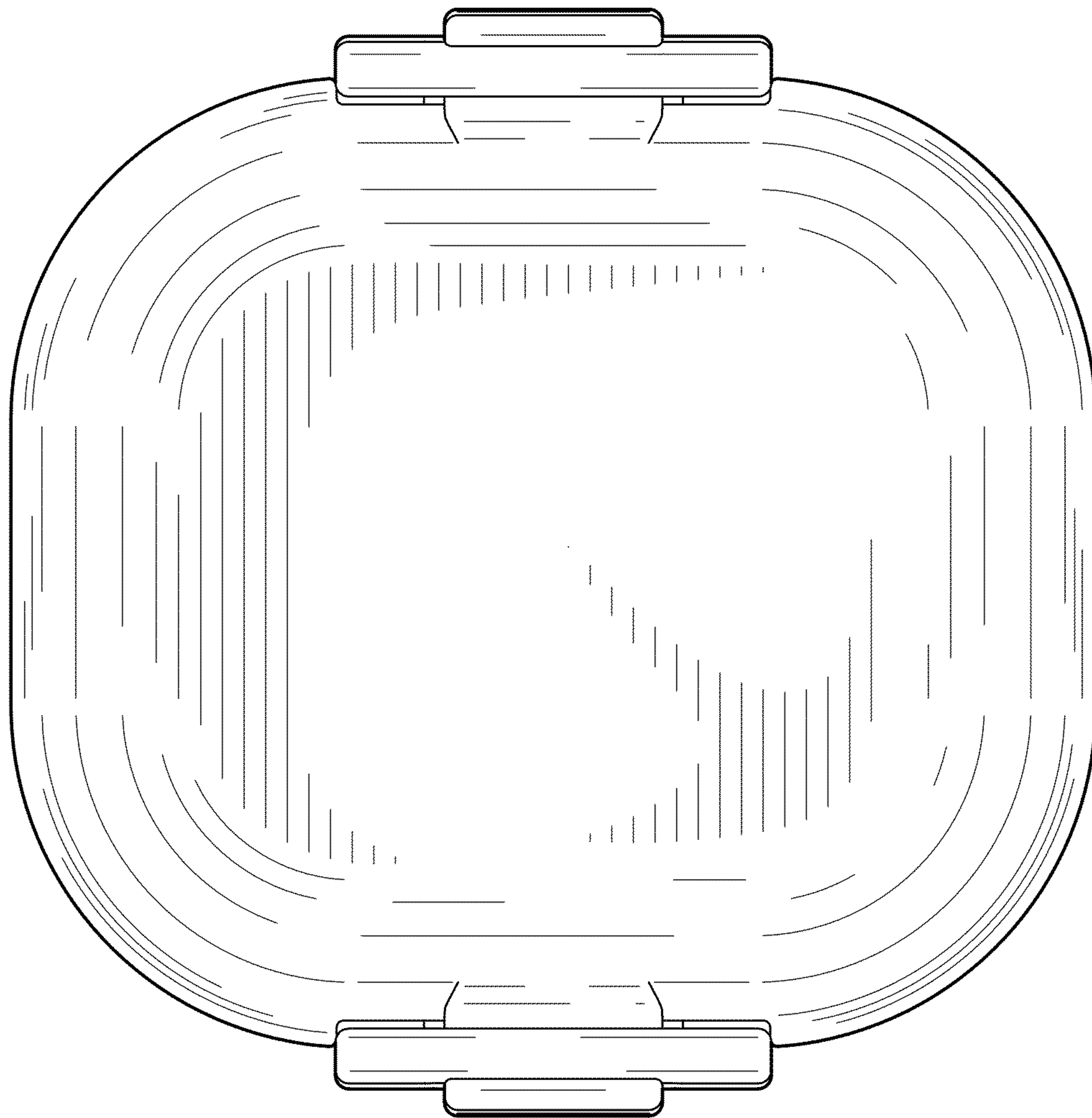

FIG.2

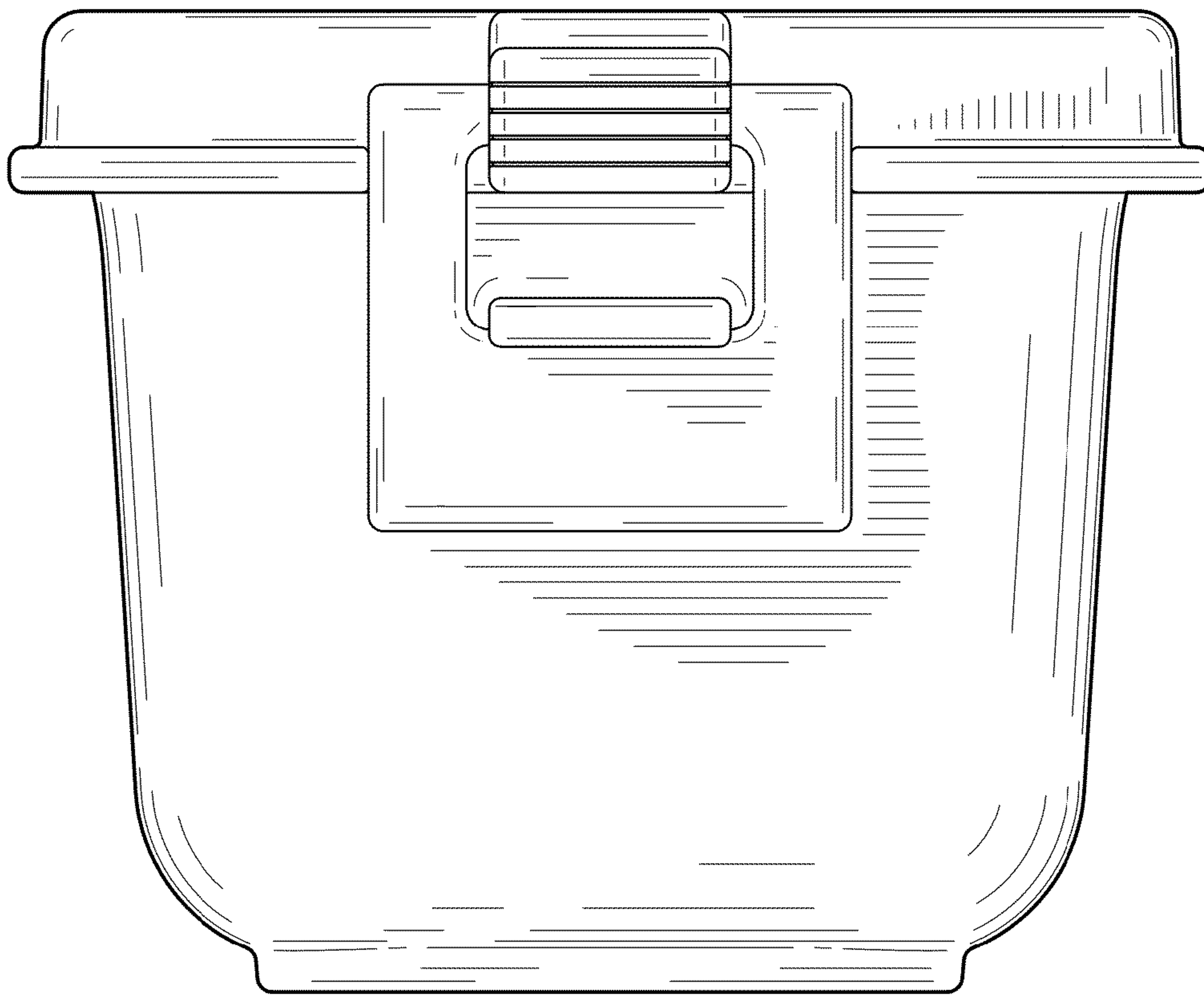

FIG. 3

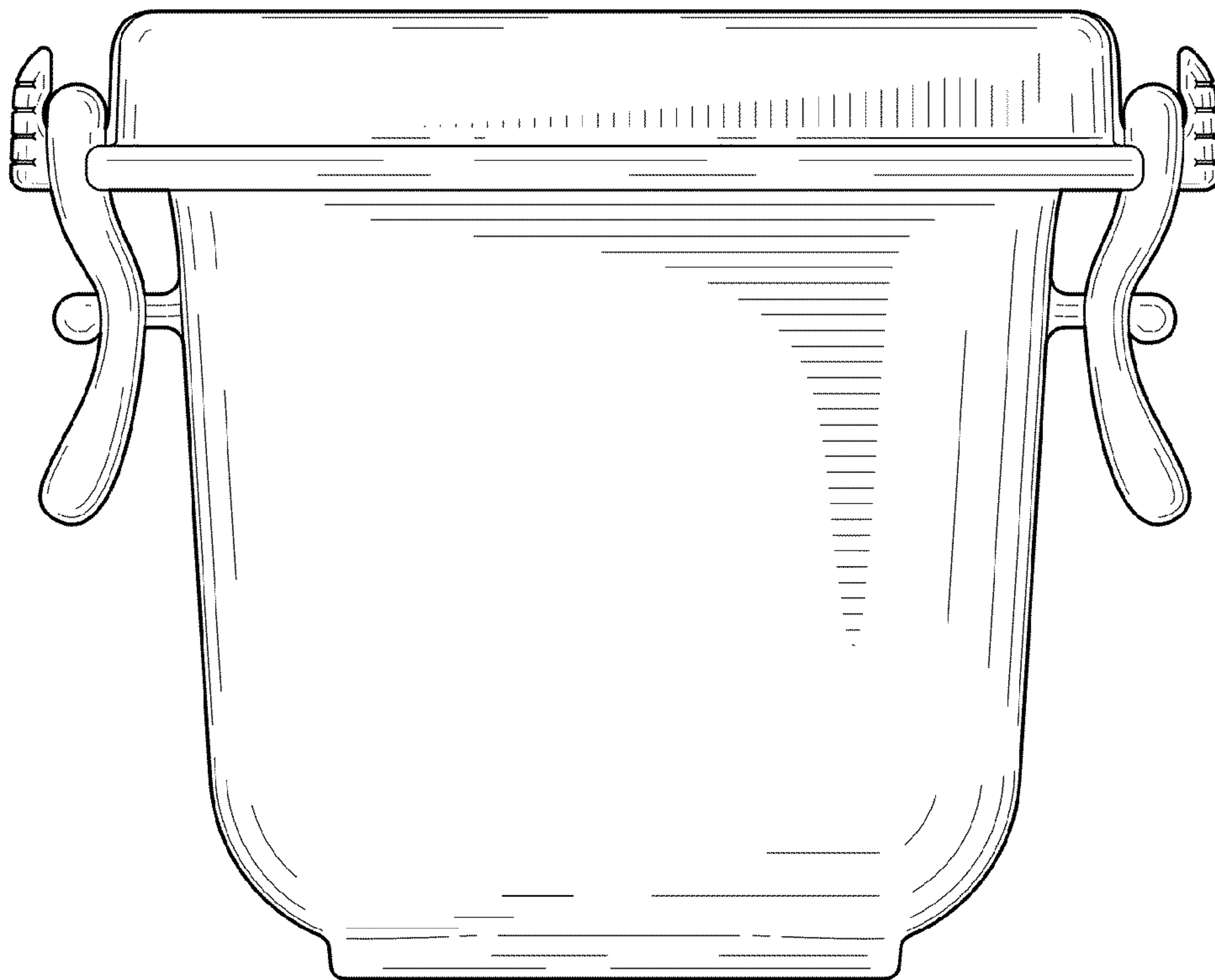

FIG.4

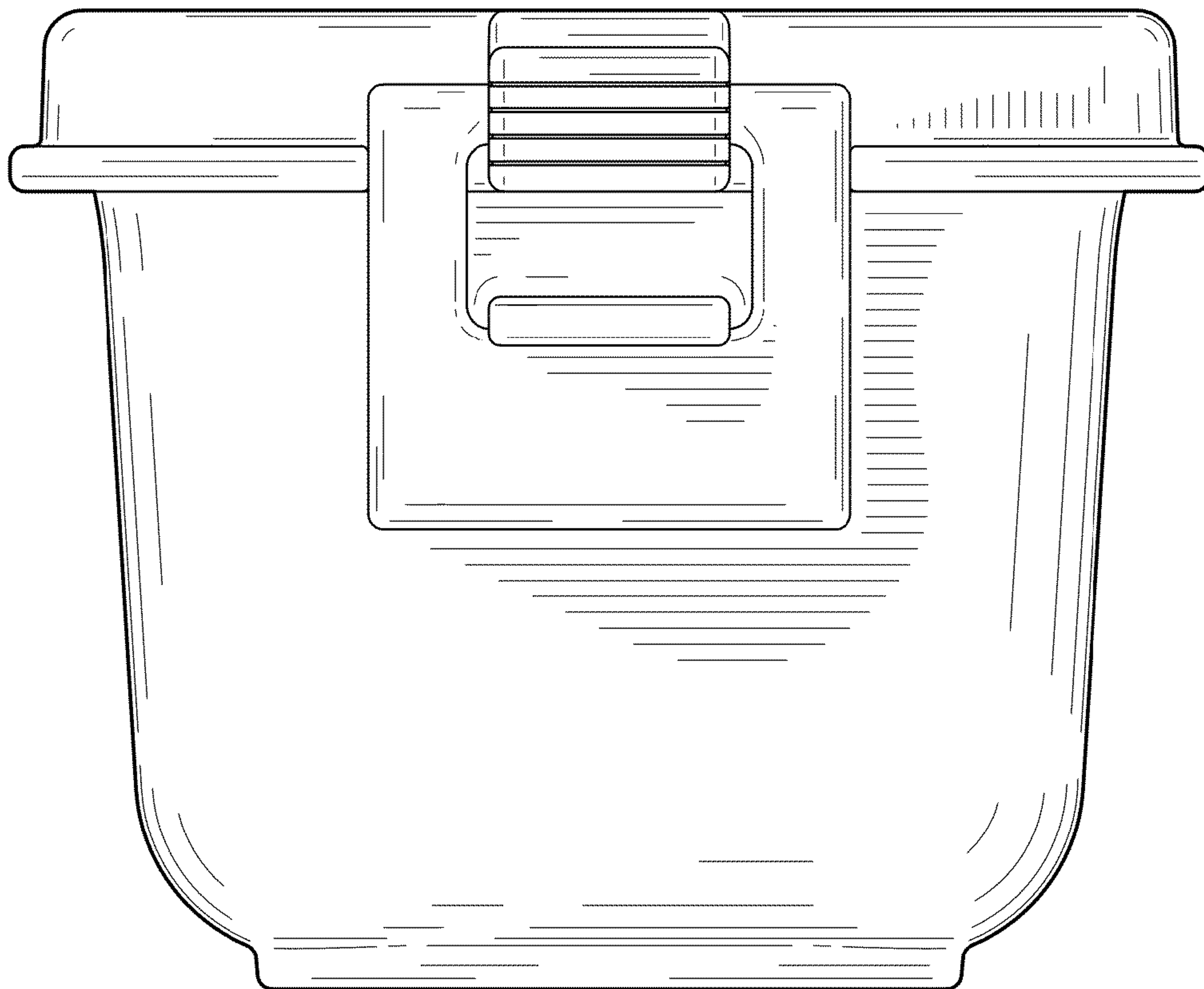

FIG.5

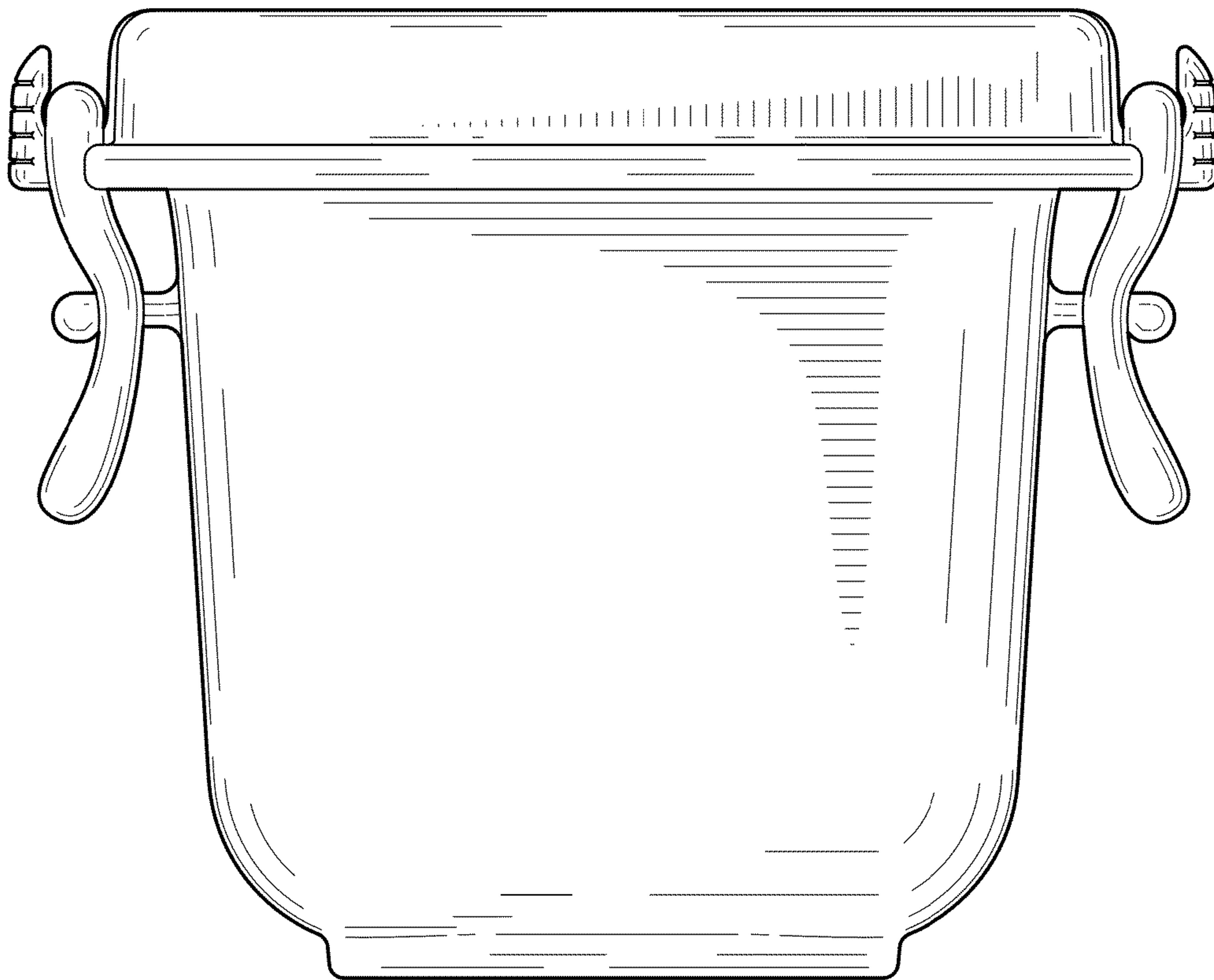

FIG.6

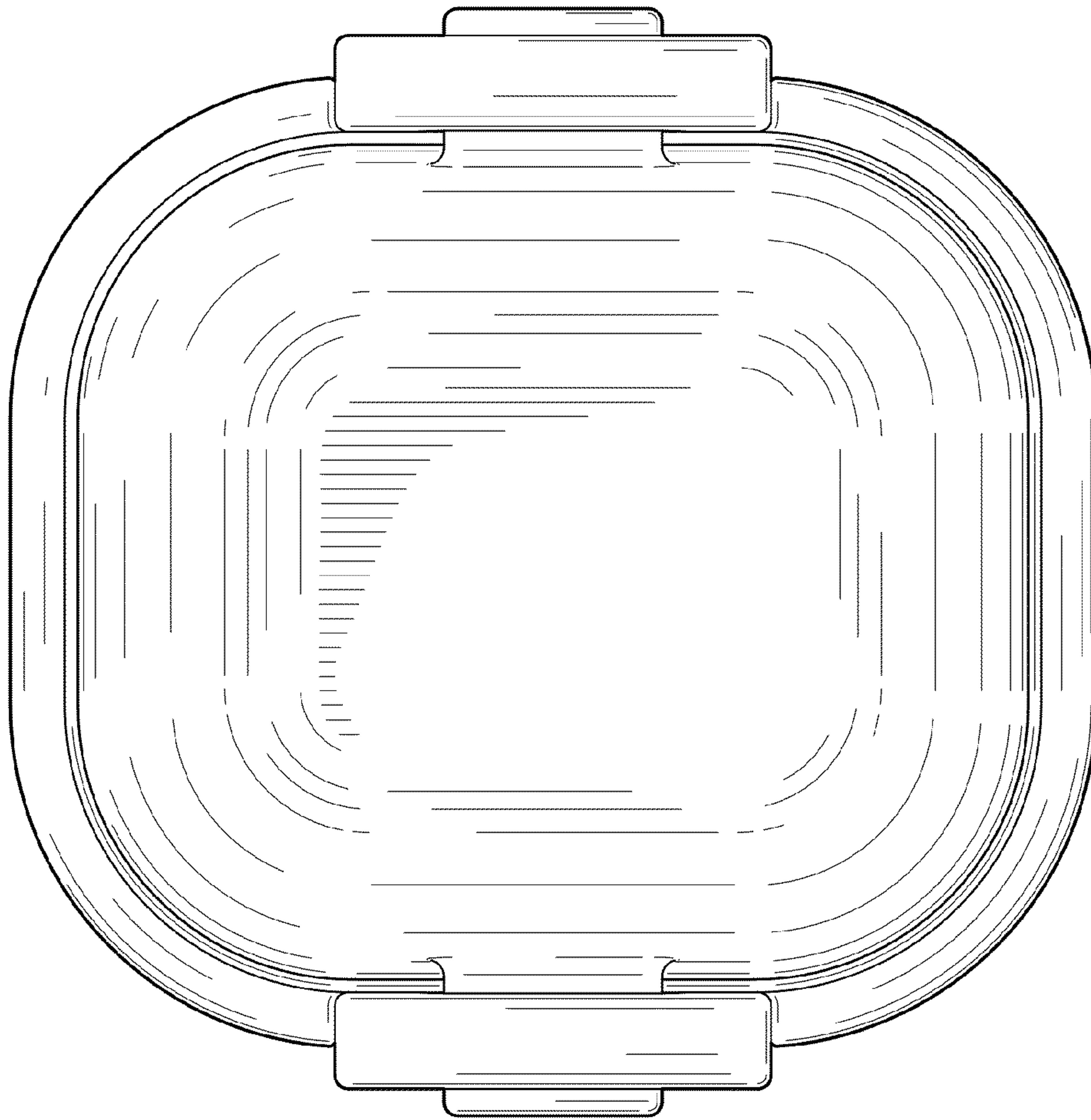

FIG. 7

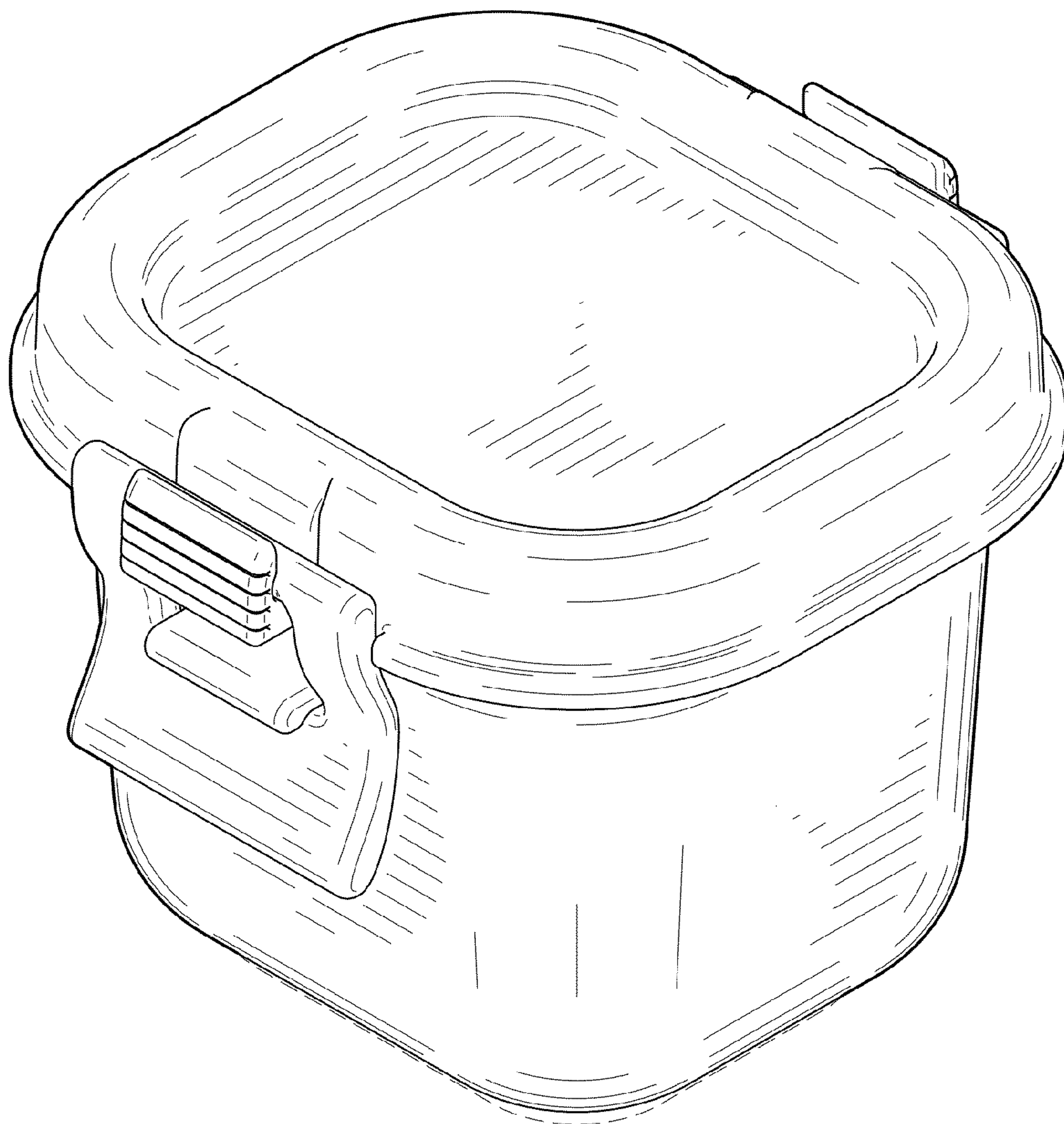

FIG. 8

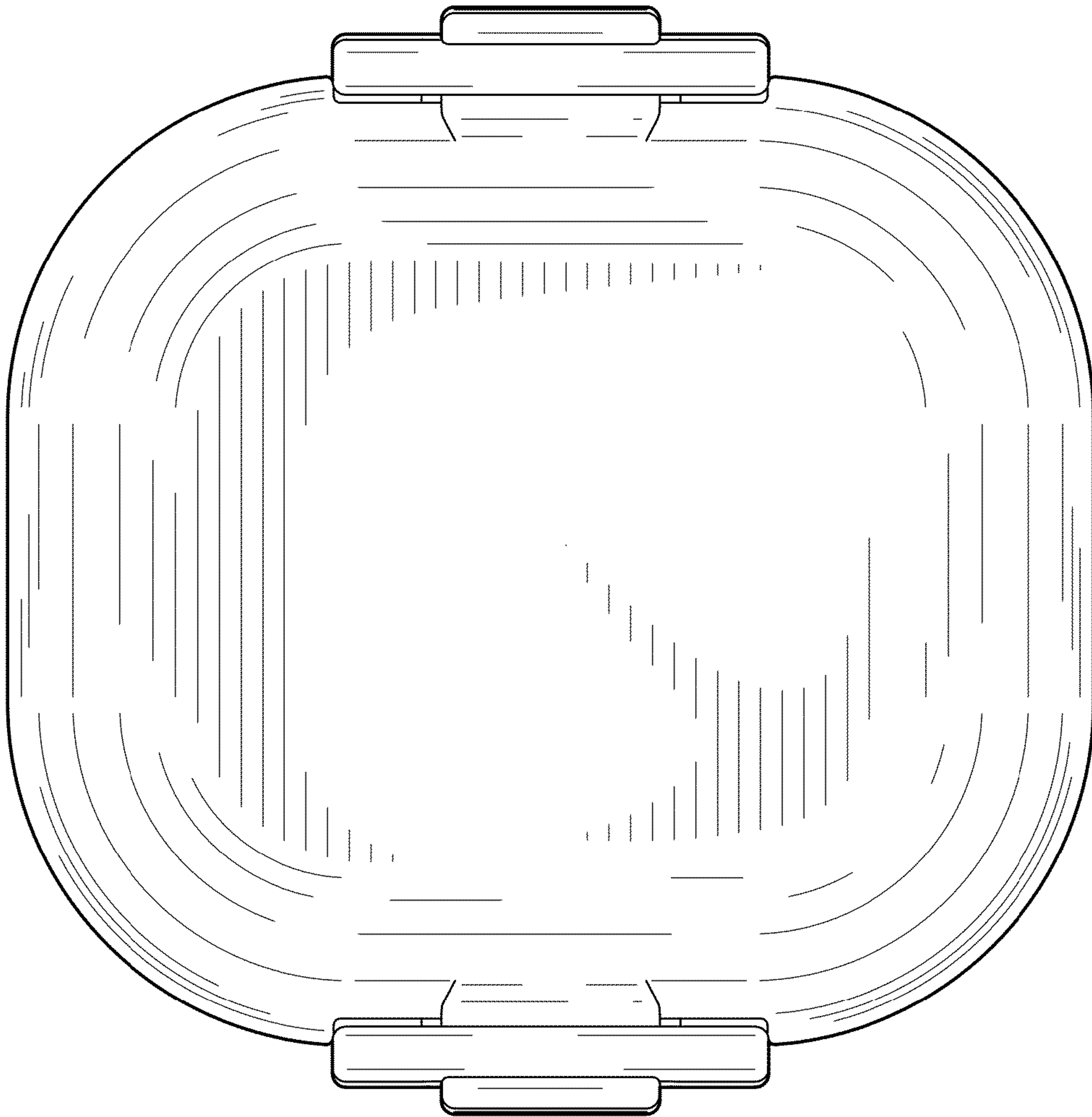

FIG. 9

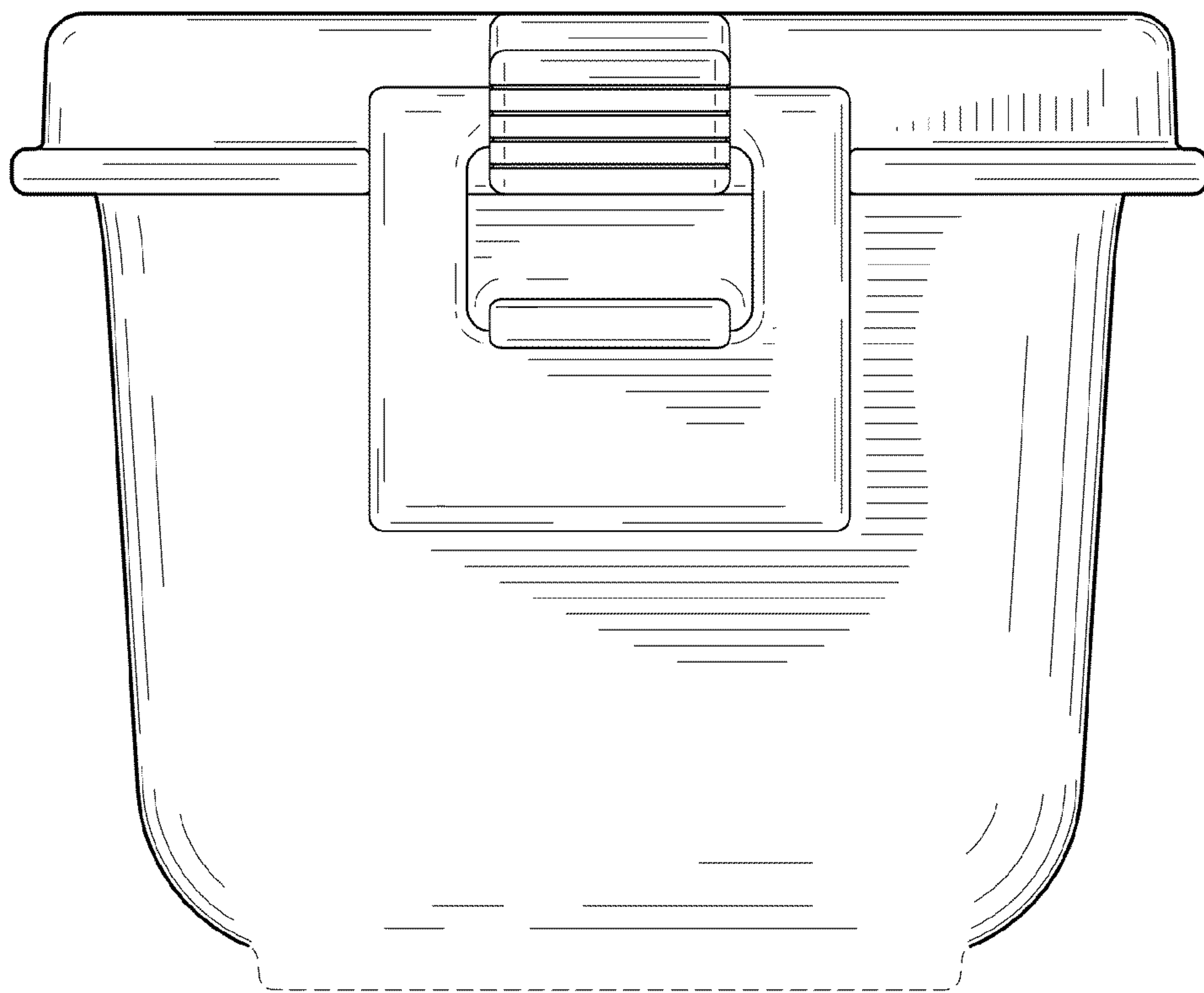

FIG.10

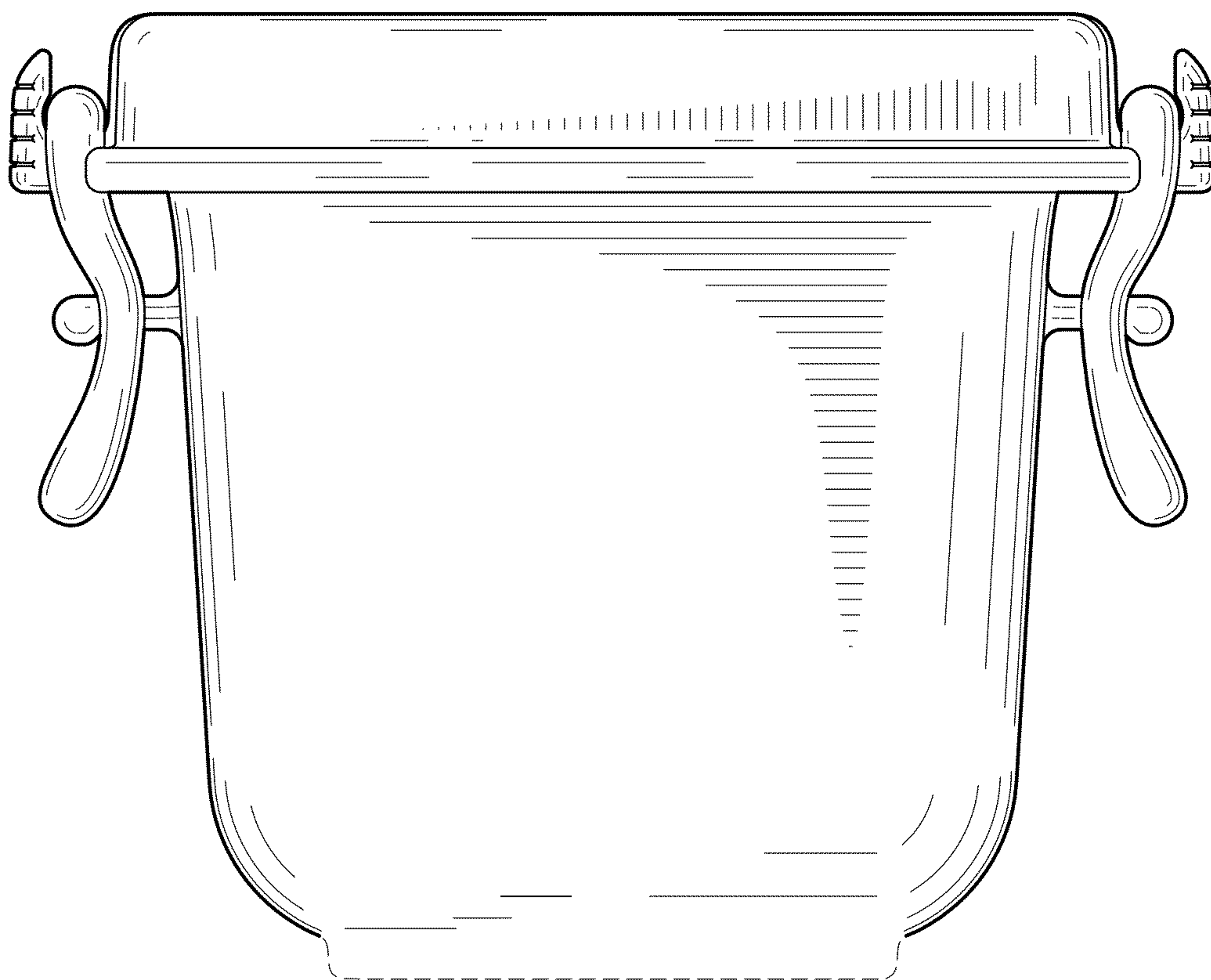

FIG. 11

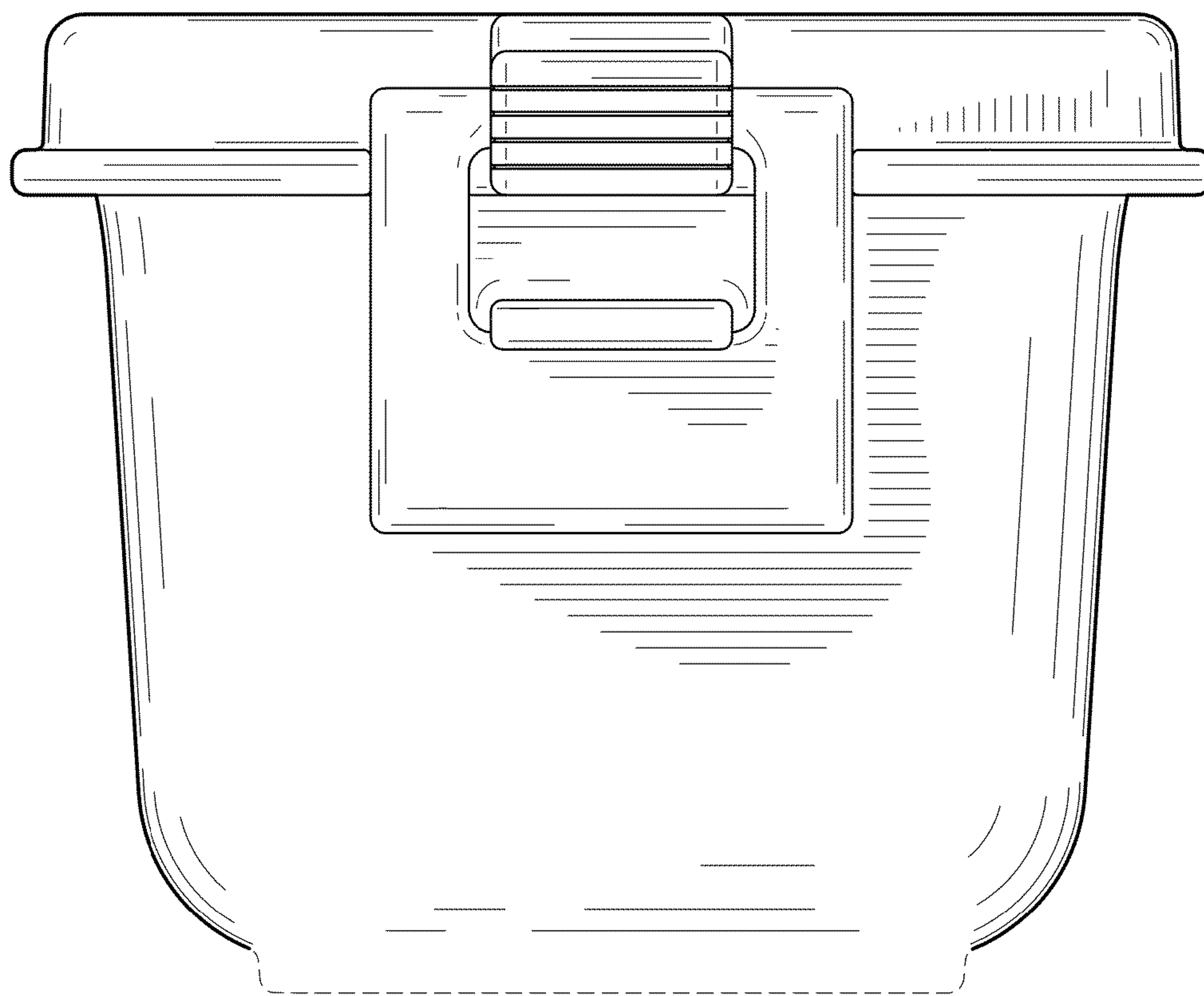

FIG.12

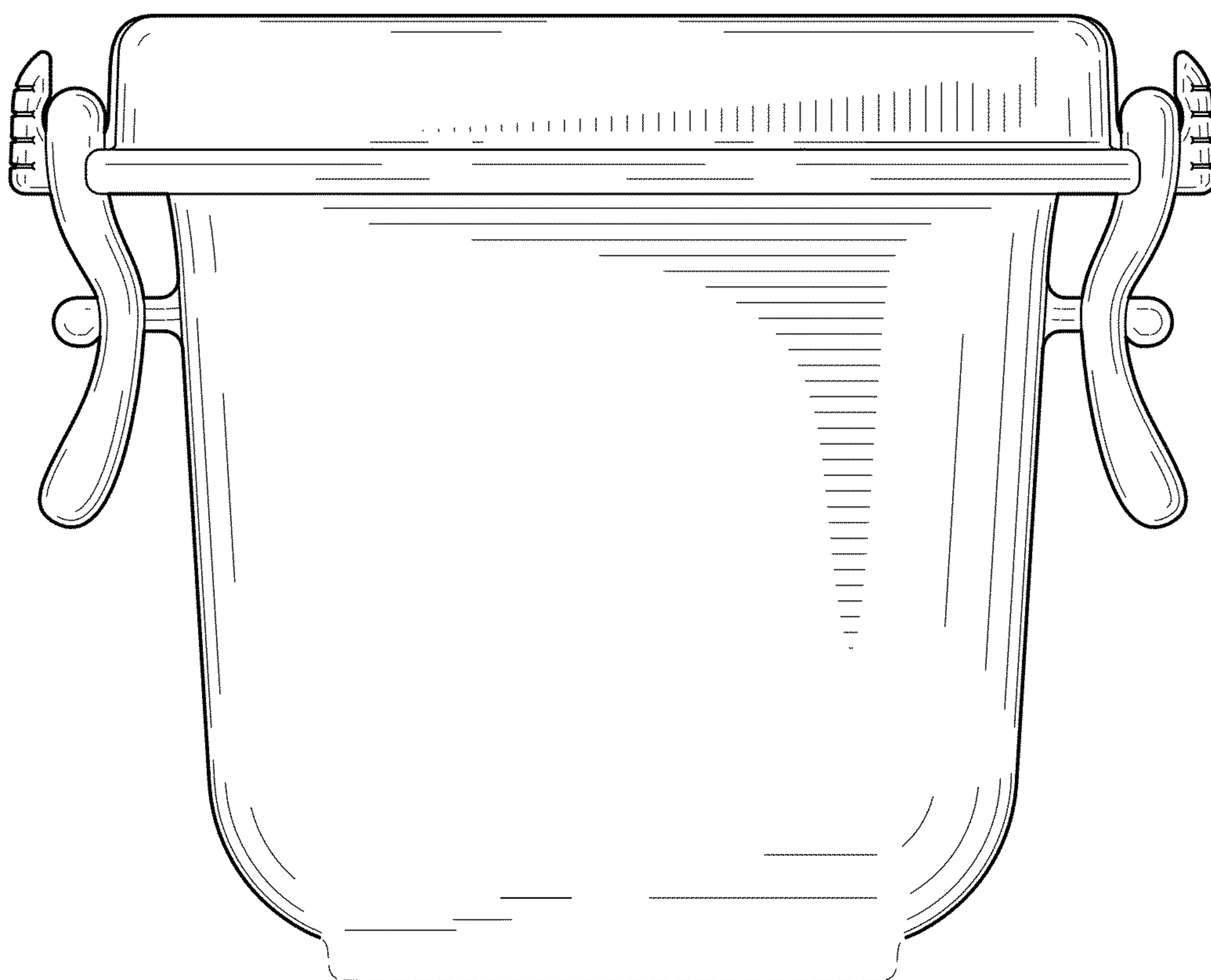

FIG.13

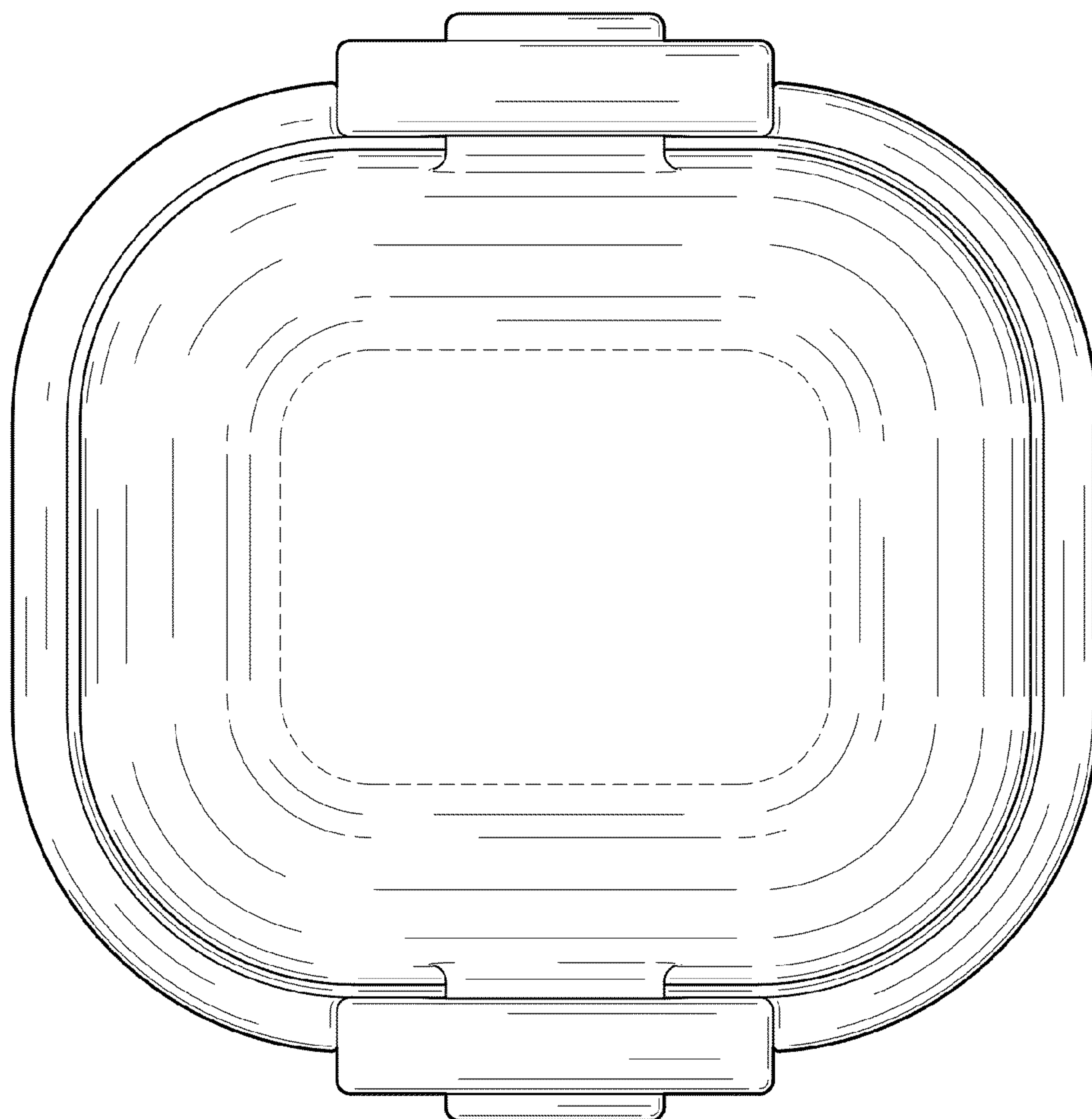

FIG.14