

US00D692208S

(12) **United States Design Patent**
LaCour-Phillippi

(10) **Patent No.:** **US D692,208 S**

(45) **Date of Patent:** **** *Oct. 29, 2013**

(54) **TIGHT FITTING SANITARY ABSORBENT UNDER SHORTS**

(76) Inventor: **Anita LaCour-Phillippi**, Eden Prairie, MN (US)

(*) Notice: This patent is subject to a terminal disclaimer.

(**) Term: **14 Years**

(21) Appl. No.: **29/416,194**

(22) Filed: **Mar. 20, 2012**

(51) **LOC (9) Cl.** **02-01**

(52) **U.S. Cl.**
USPC **D2/712**

(58) **Field of Classification Search**
USPC D2/700, 701, 702, 703, 704, 705, 711, D2/712, 713, 714, 731, 738, 742; D24/200, 226; 2/46, 67, 69, 78.1, 78.2, 2/78.3, 78.4, 227, 228, 238, 400, 401, 2/402, 403, 404, 405; 66/177; 450/94, 450/99, 100, 101, 102, 103, 104, 114, 115, 450/116; 600/38, 41; 602/67; 604/358, 366, 604/385.01, 385.13, 396

See application file for complete search history.

(56) **References Cited**

U.S. PATENT DOCUMENTS

387,159 A *	7/1888	Grossmann	604/395
2,490,137 A *	12/1949	Keller	450/102
2,732,556 A *	1/1956	Erteszek	450/104
D179,336 S *	12/1956	Bayer	D2/702
3,013,562 A *	12/1961	Blatt	450/104
3,044,470 A *	7/1962	Gourdon	450/104
3,279,469 A *	10/1966	Schustack	450/113
D210,815 S *	4/1968	Brigham	D2/704
D211,232 S *	6/1968	Tenusiak	D2/704
D213,667 S *	4/1969	Salisky	D2/704
D213,947 S *	4/1969	Dubner	D2/704
3,768,481 A	10/1973	Shibata	
D229,899 S *	1/1974	Williams	D2/704
3,824,812 A *	7/1974	Matthews et al.	66/177
D234,984 S *	4/1975	Gentile	D2/704

4,641,381 A	2/1987	Heran et al.	
4,745,636 A	5/1988	Lunt	
4,813,950 A	3/1989	Branch	
4,938,753 A	7/1990	Van Gompel et al.	
5,037,416 A	8/1991	Allen et al.	
5,163,932 A	11/1992	Nomura et al.	
5,390,376 A *	2/1995	Marx et al.	2/406
5,440,764 A	8/1995	Matsushita	
5,827,261 A	10/1998	Osborn, III et al.	
5,944,708 A	8/1999	Philpott	
6,049,916 A	4/2000	Rajala et al.	
6,240,569 B1	6/2001	Van Gompel et al.	
6,270,469 B1 *	8/2001	Mott	602/61
6,287,169 B1	9/2001	Willms et al.	
6,367,089 B2	4/2002	Van Gompel et al.	
6,613,034 B2	9/2003	Nozaki et al.	
6,807,685 B1	10/2004	Hasegawa et al.	
6,848,121 B1 *	2/2005	Halid	2/400
7,150,731 B2	12/2006	Cazzato et al.	
7,344,524 B2	3/2008	Cazzato et al.	
7,419,562 B2	9/2008	Van Gompel et al.	
7,837,665 B2	11/2010	Van Gompel et al.	
2001/0007935 A1	7/2001	Gompel et al.	
2004/0054340 A1	3/2004	Mitchell	
2006/0161131 A1	7/2006	Kurta et al.	
2011/0111673 A1 *	5/2011	Soeda	450/1

FOREIGN PATENT DOCUMENTS

EP	0650350 B1	7/1993
EP	0716587 B1	8/1994
EP	0716587 B2	8/1994
EP	1327430 A2	1/1996
EP	1327430 A3	1/1996
EP	1327430 B1	1/1996
EP	1327431 A3	1/1996
EP	1327432 A2	1/1996
EP	1327432 A3	1/1996
EP	0886509 B1	2/1997
WO	WO9506451 A1	8/1994

* cited by examiner

Primary Examiner — Karen E Eldridge Powers
(74) *Attorney, Agent, or Firm* — Antonio Papageorgiou; Ostrow Kaufman LLP

(57) **CLAIM**
The ornamental design for tight fitting sanitary absorbent under shorts, as shown and described.

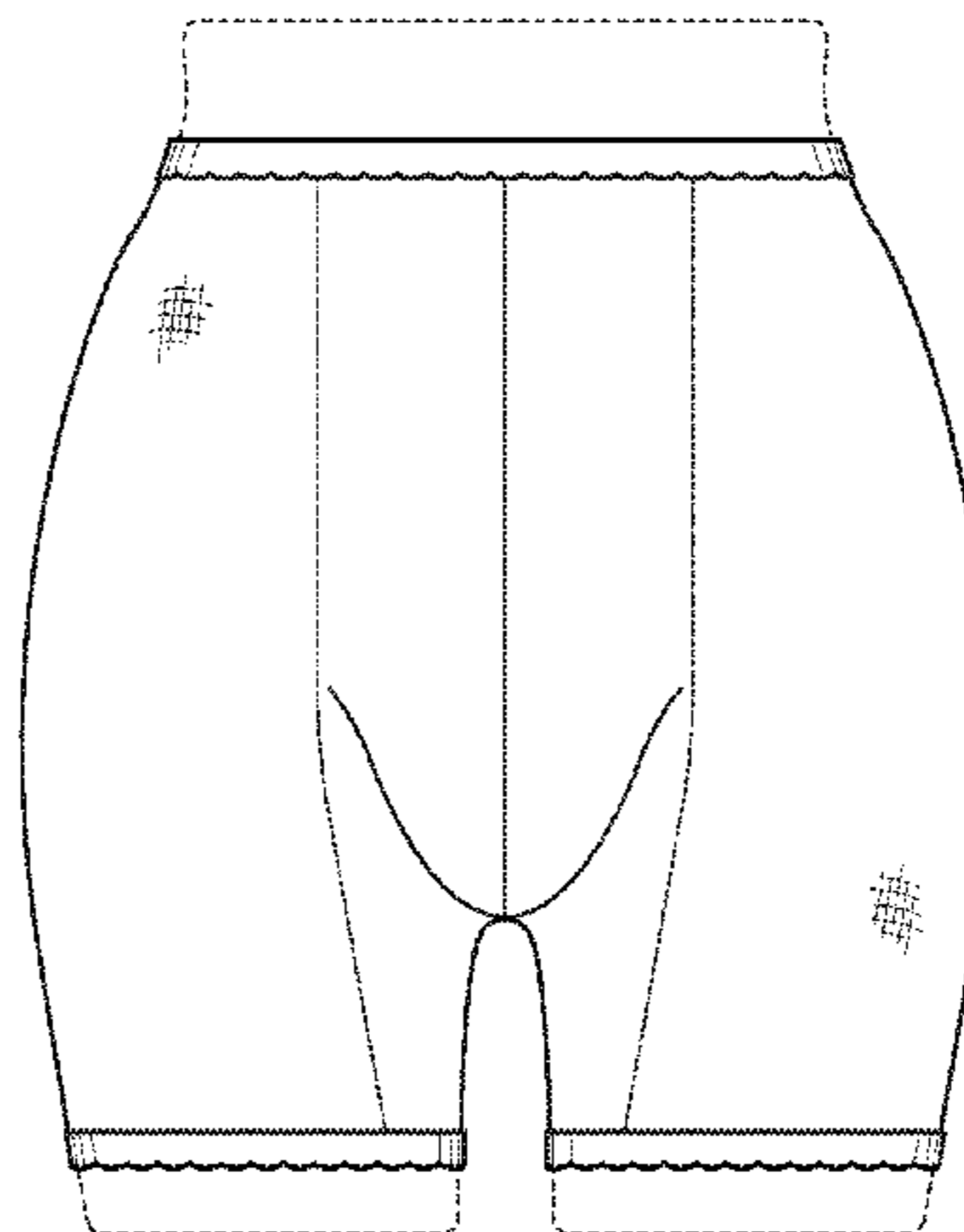
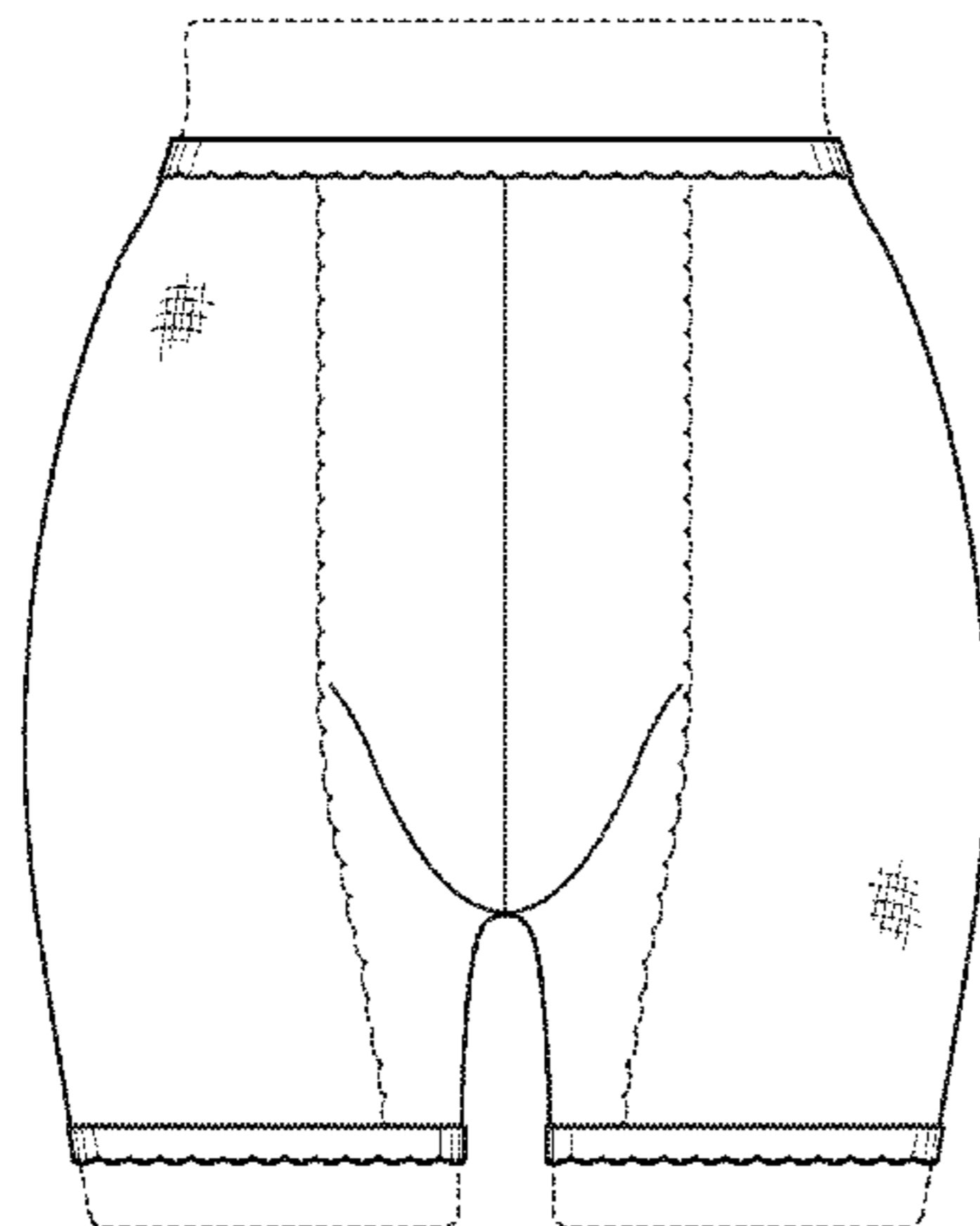

DESCRIPTION

FIG. 1 is a perspective view of one side and the front of a first embodiment of the tight fitting sanitary absorbent under shorts with front and back scalloped stitching, clothing the female form, according to one embodiment of my new design;

FIG. 2 is a front elevation view thereof;

FIG. 3 is a right side elevation view thereof;

FIG. 4 is a left side elevation view thereof;

FIG. 5 is a back elevation view thereof;

FIG. 6 is a top plan view thereof; and

FIG. 7 is a bottom plan view thereof.

FIG. 8 is a perspective view of one side and the front of a second embodiment of the tight fitting sanitary absorbent under shorts with front and back scalloped stitching, clothing the female form, according to one embodiment of my new design;

FIG. 9 is a front elevation view thereof;

FIG. 10 is a right side elevation view thereof;

FIG. 11 is a left side elevation view thereof;

FIG. 12 is a back elevation view thereof;

FIG. 13 is a top plan view thereof; and

FIG. 14 is a bottom plan view thereof.

FIG. 15 is a perspective view of one side and the front of a third embodiment of the tight fitting sanitary absorbent under shorts with front and back straight stitching, clothing the female form, according to one embodiment of my new design;

FIG. 16 is a front elevation view thereof;

FIG. 17 is a right side elevation view thereof;

FIG. 18 is a left side elevation view thereof;

FIG. 19 is a back elevation view thereof;

FIG. 20 is a top plan view thereof; and,

FIG. 21 is a bottom plan view thereof.

FIG. 22 is a perspective view of one side and the front of a fourth embodiment of the tight fitting sanitary absorbent under shorts with front and back straight stitching, clothing the female form, according to one embodiment of my new design;

FIG. 23 is a front elevation view thereof;

FIG. 24 is a right side elevation view thereof;

FIG. 25 is a left side elevation view thereof;

FIG. 26 is a back elevation view thereof;

FIG. 27 is a top plan view thereof; and,

FIG. 28 is a bottom plan view thereof.

The dashed lines on the surface of the tight fitting sanitary absorbent under shorts represent stitching.

The scalloped and straight stitching shown in dashed lines are part of the claimed design.

The partial human figure shown in broken lines in the drawings illustrates the environment in which the claimed design is used and assists in showing how the design appears when worn. The partial human figure forms no part of the claim.

1 Claim, 28 Drawing Sheets

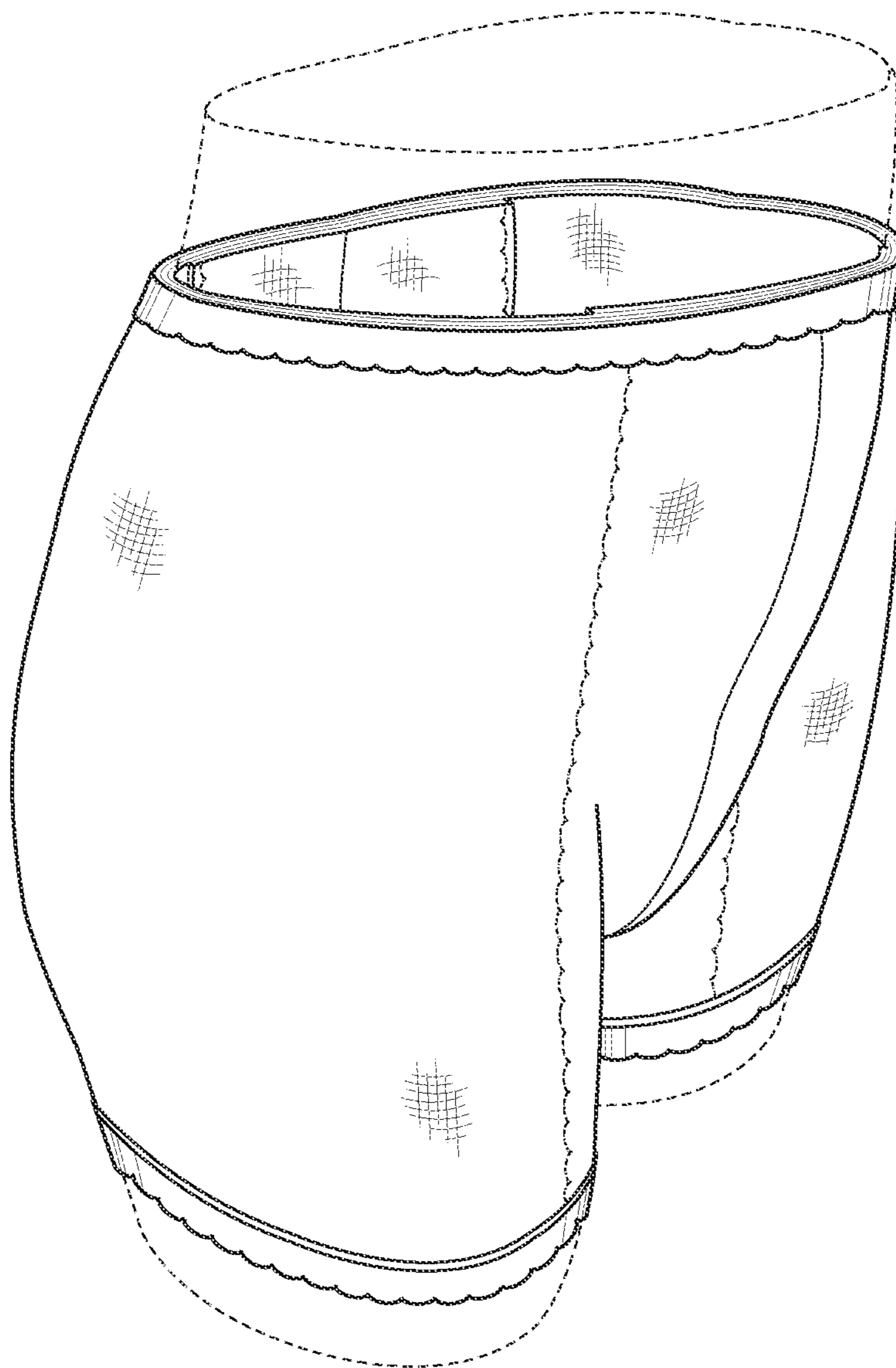

FIG. 1

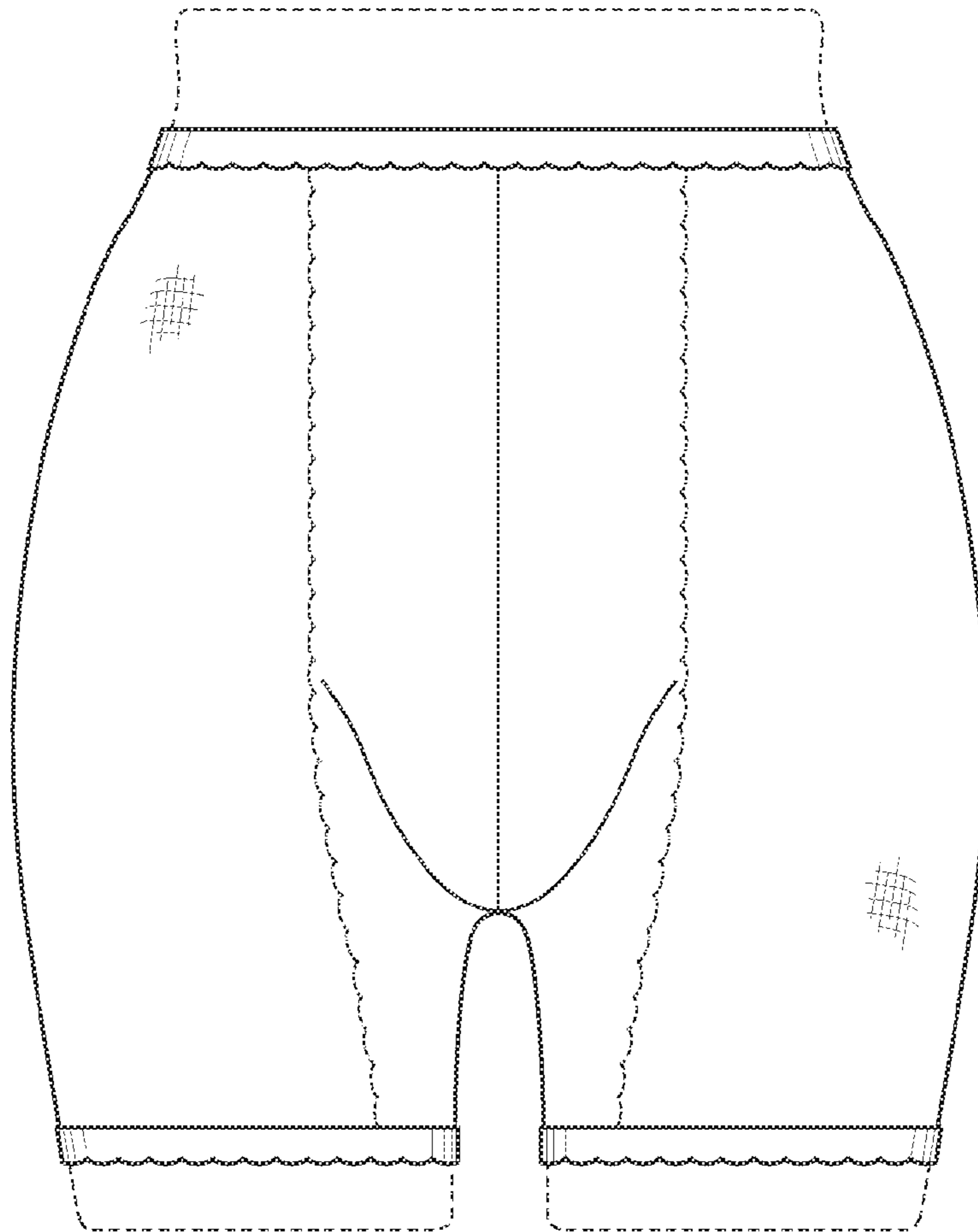

FIG. 2

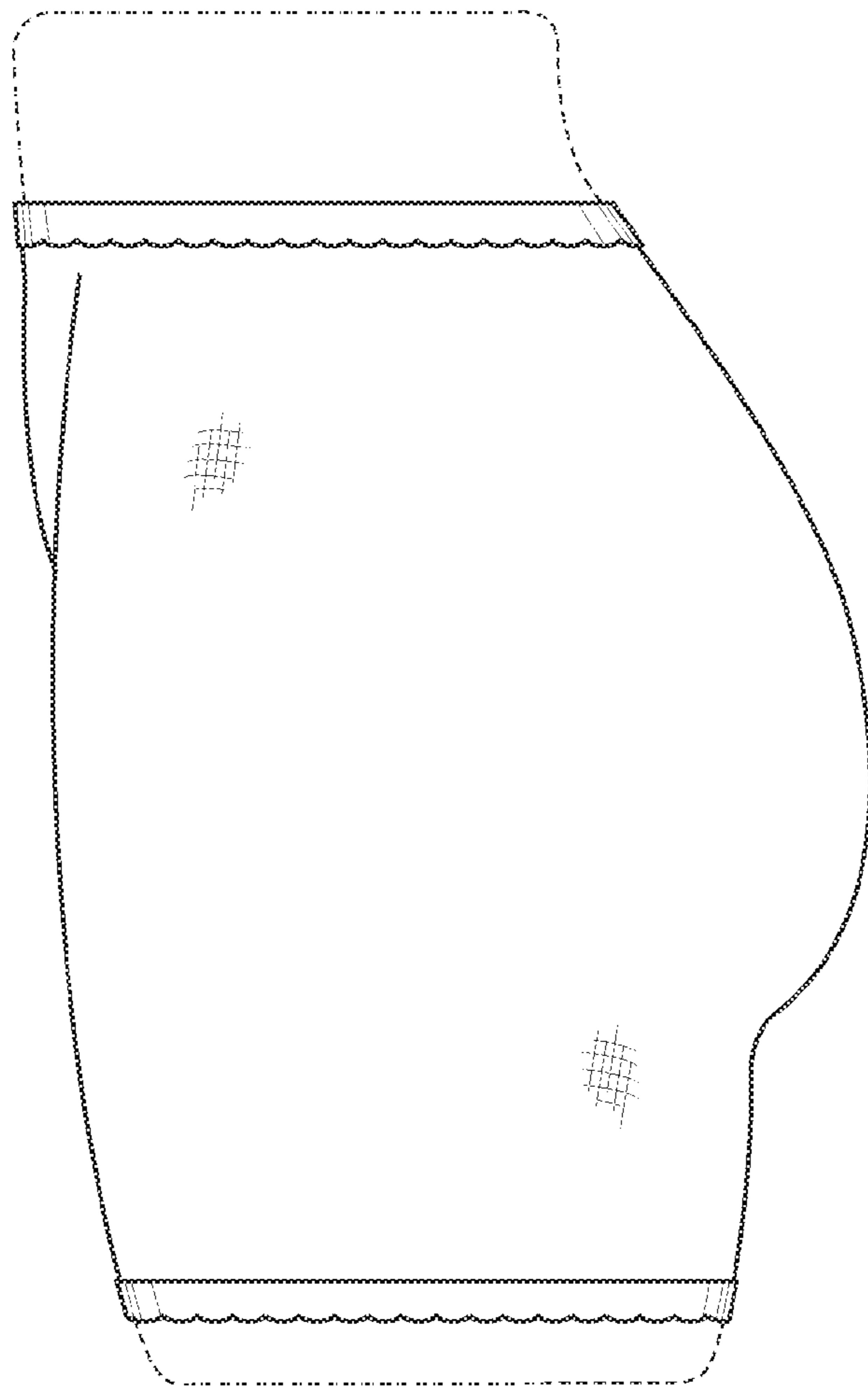

FIG. 3

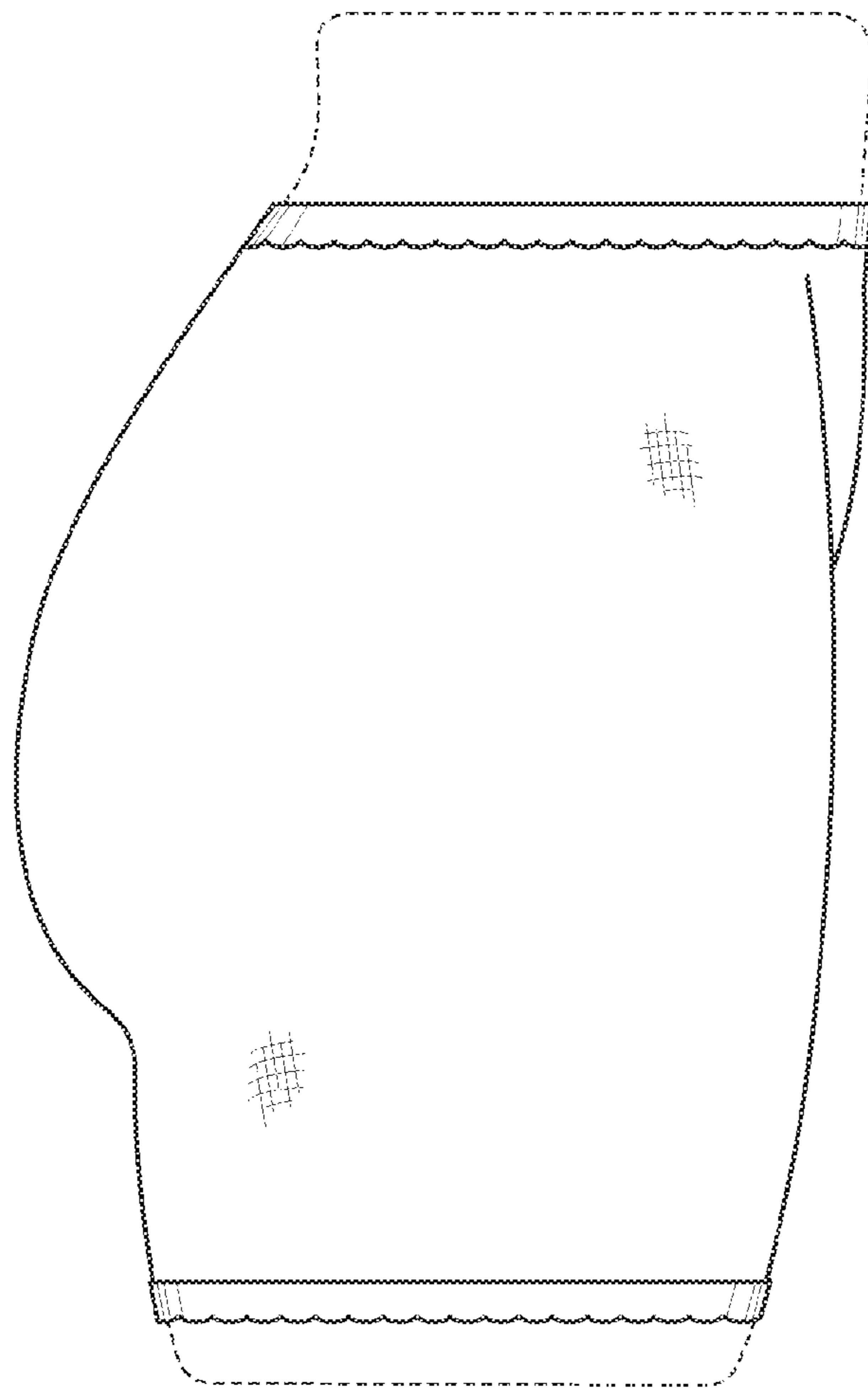

FIG. 4

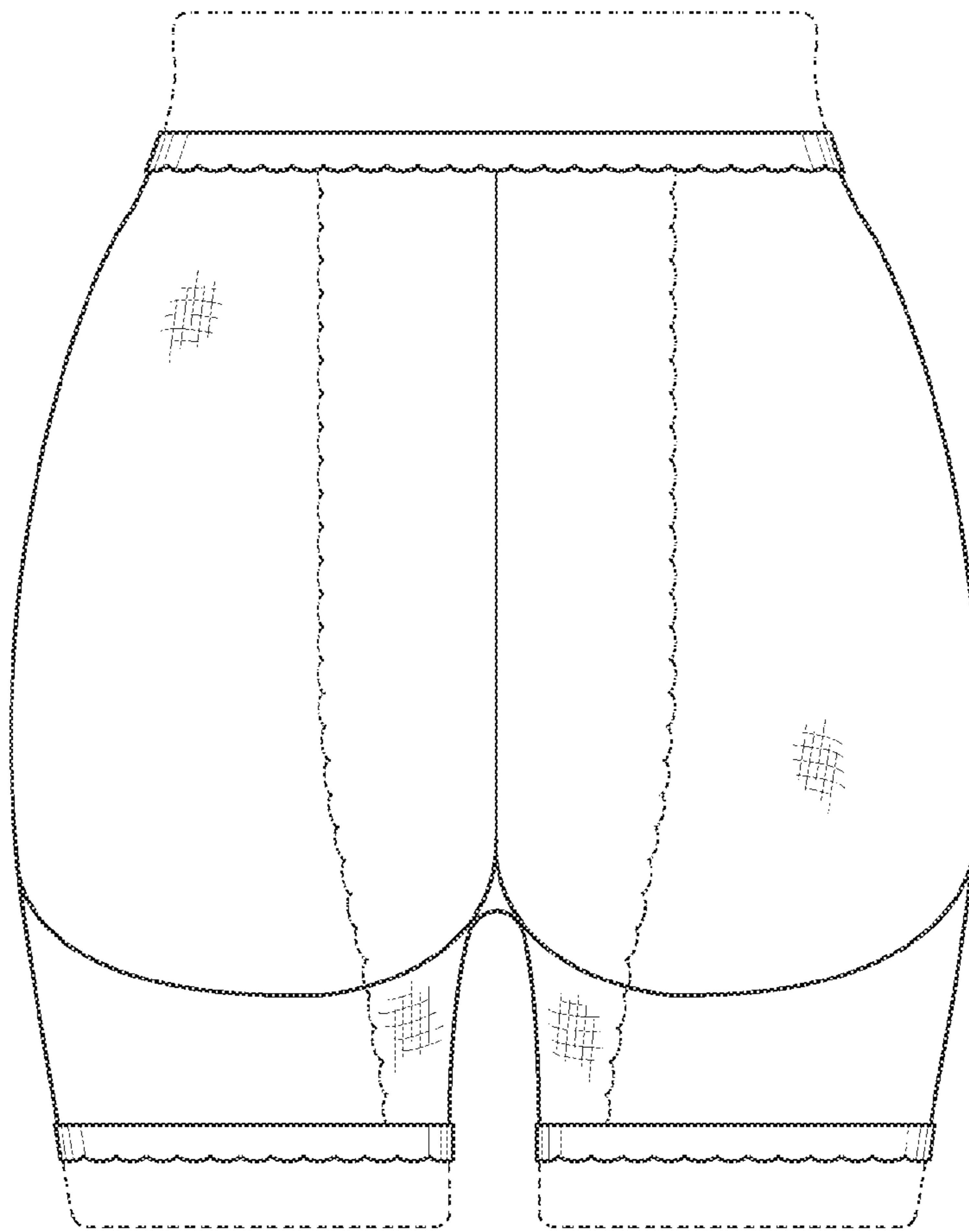

FIG. 5

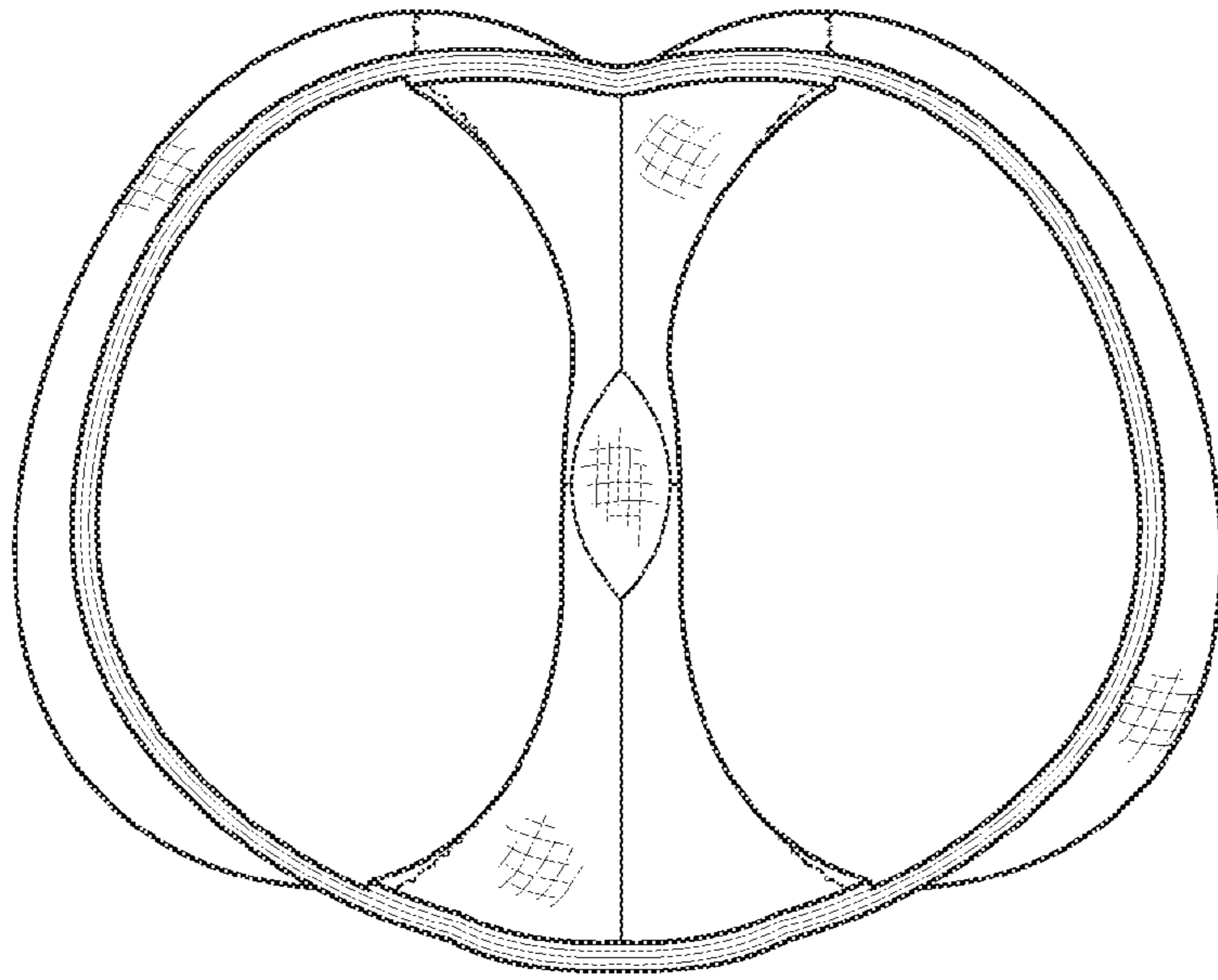

FIG. 6

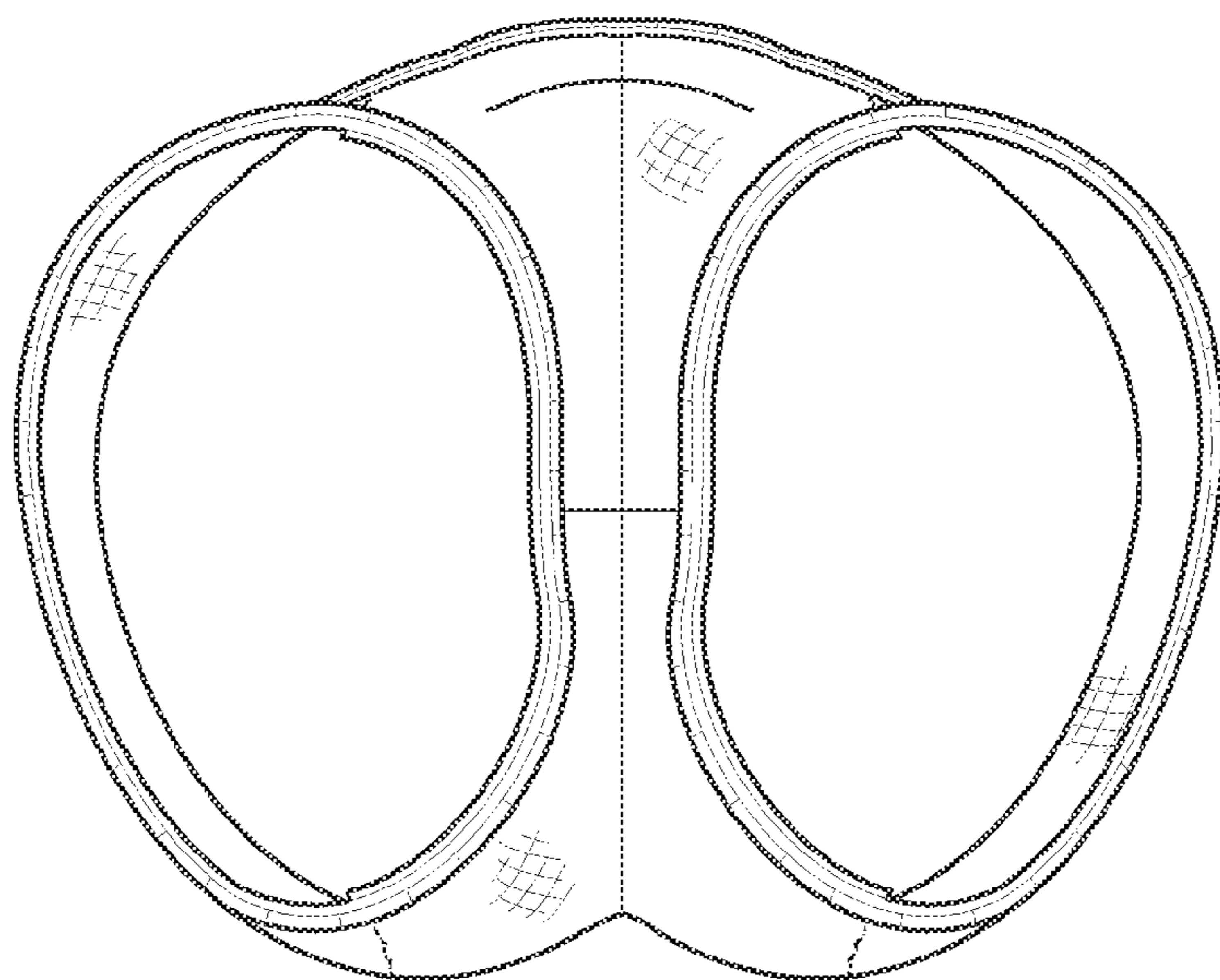

FIG. 7

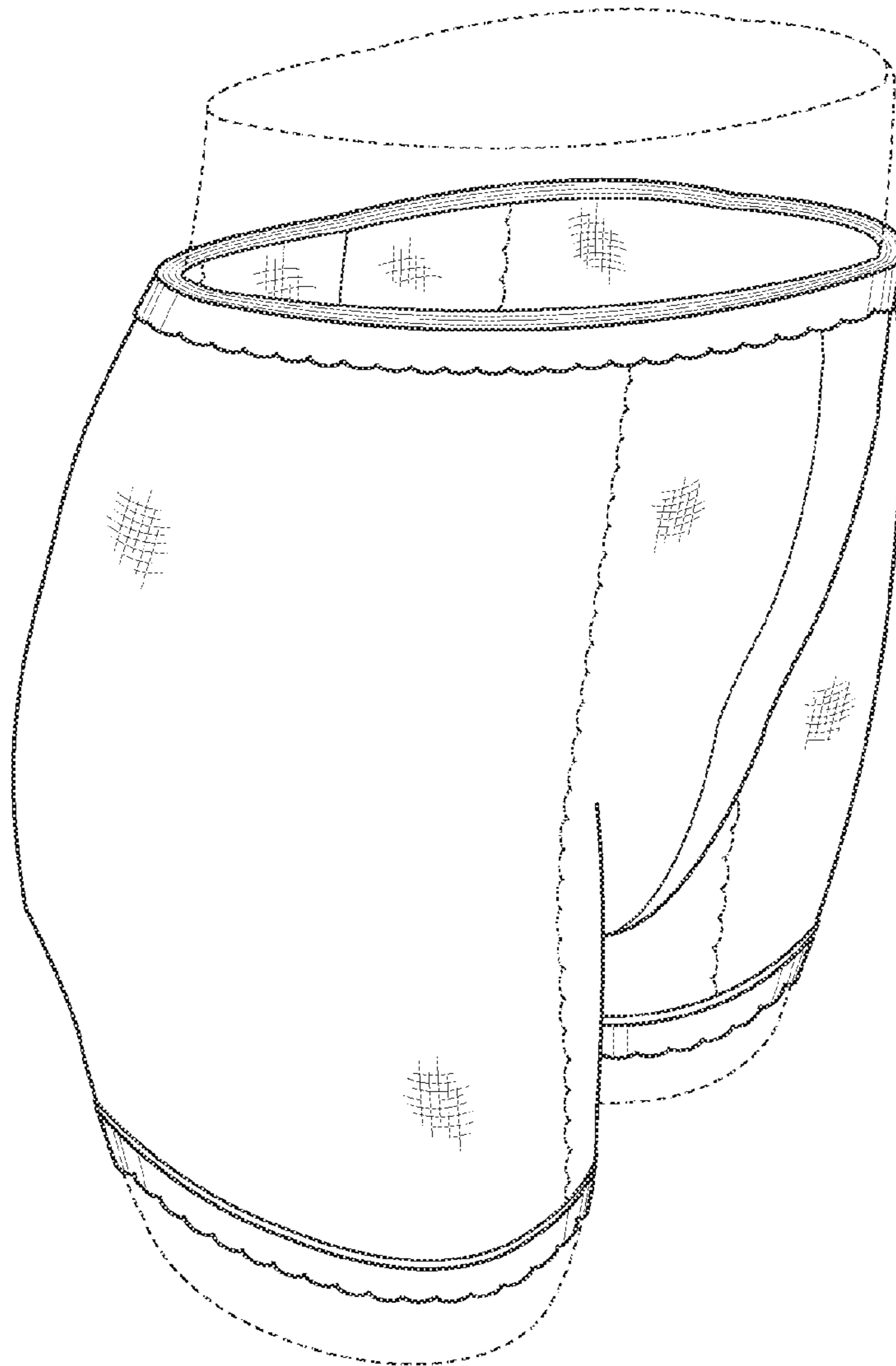

FIG. 8

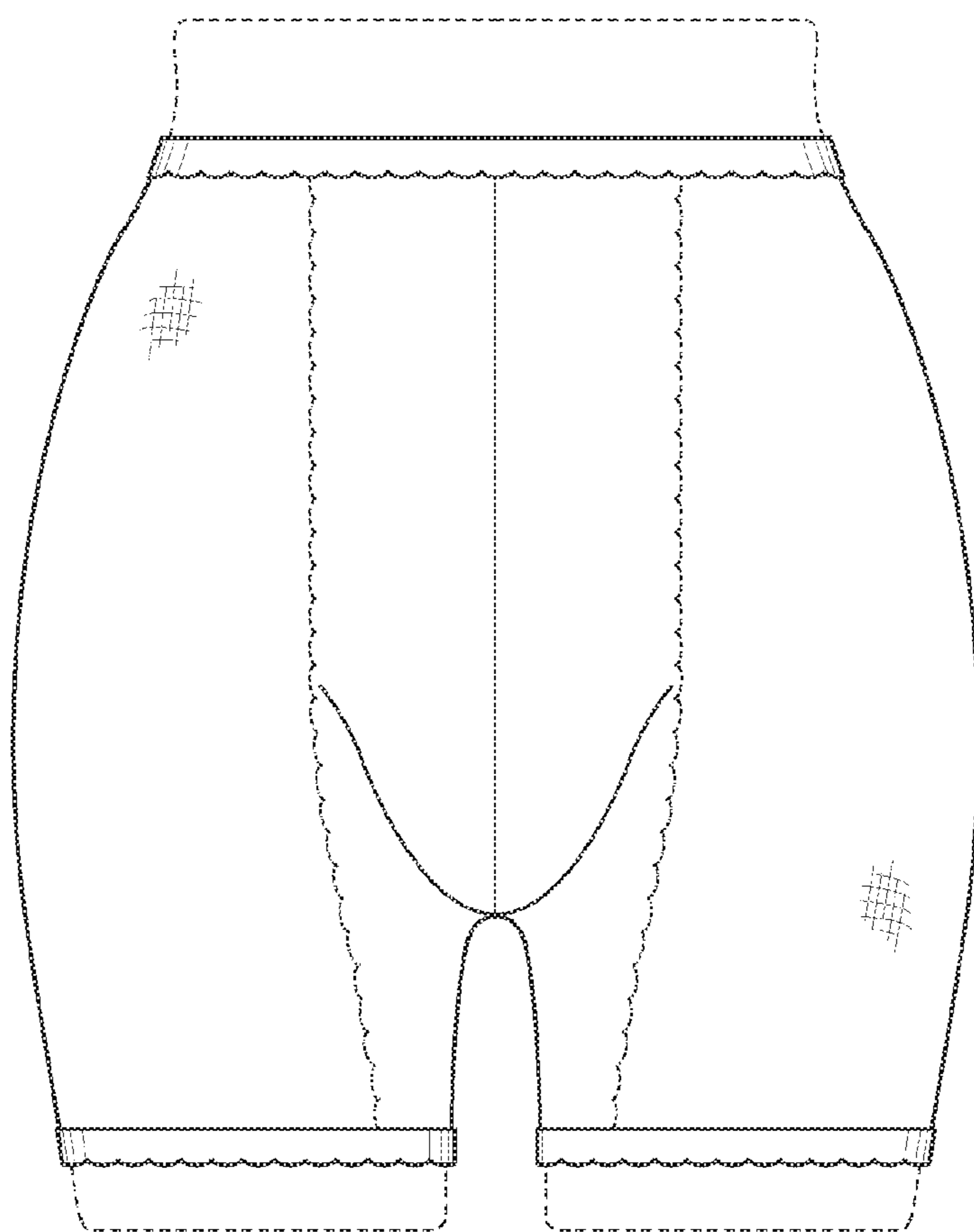

FIG. 9

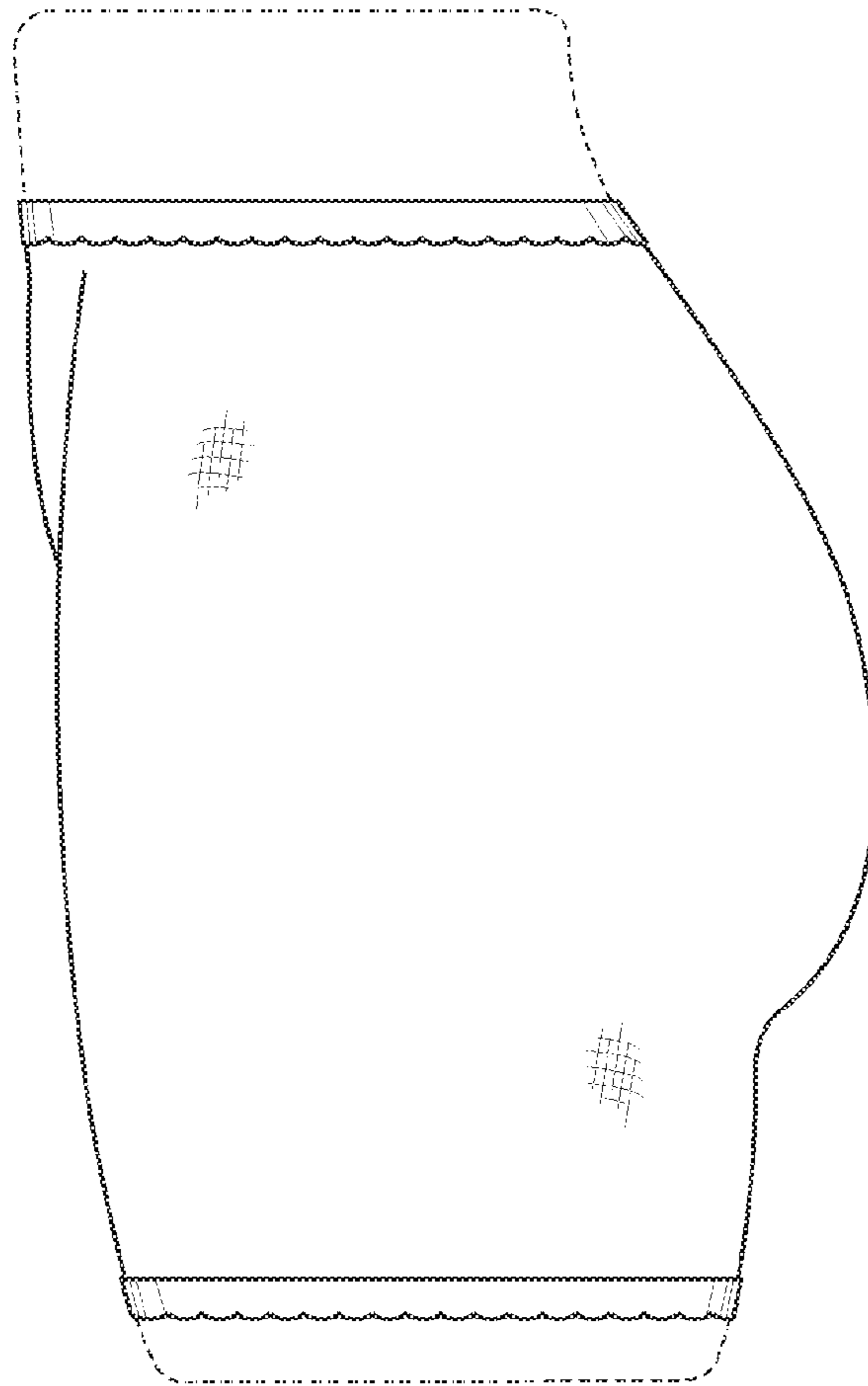

FIG. 10

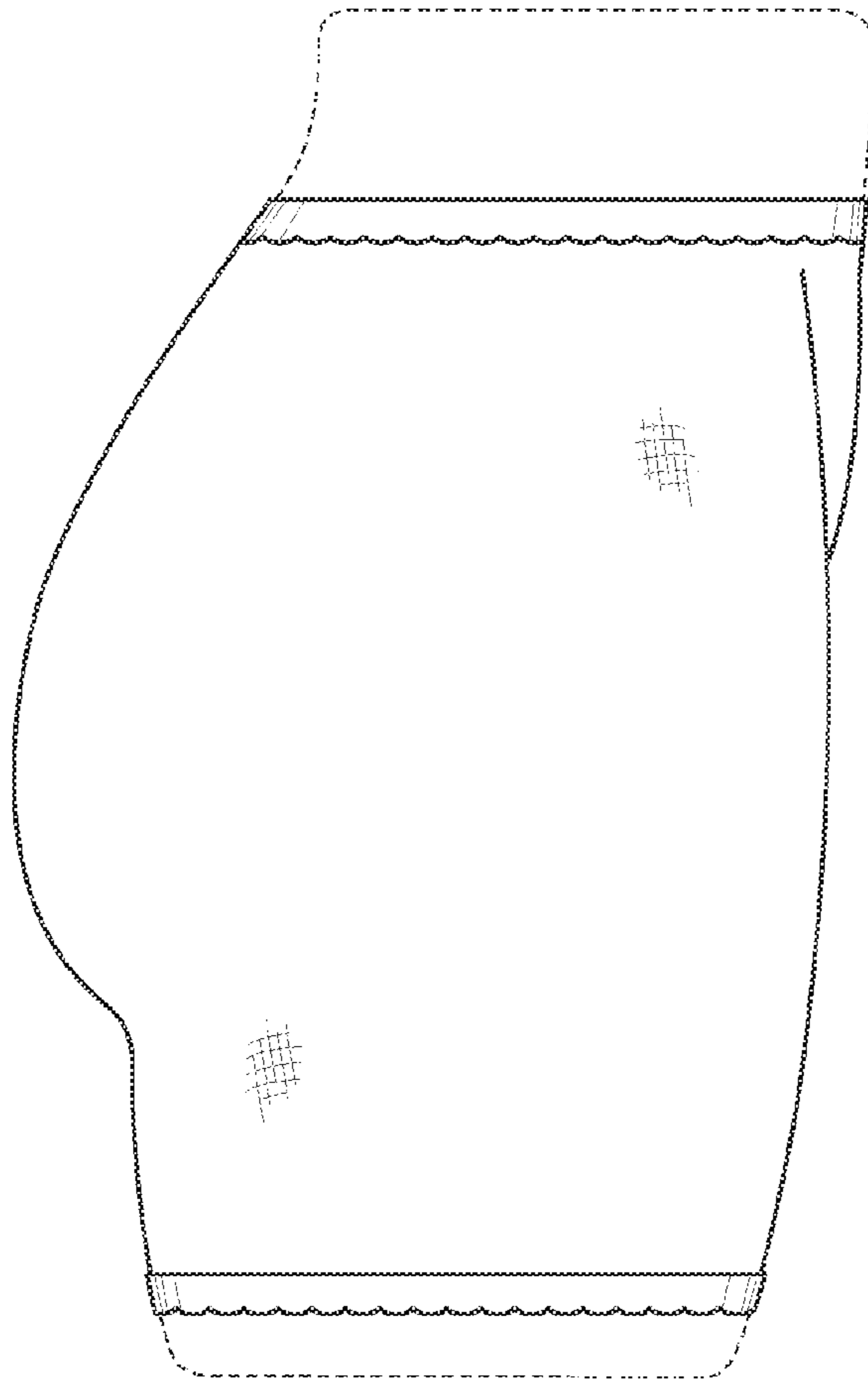

FIG. 11

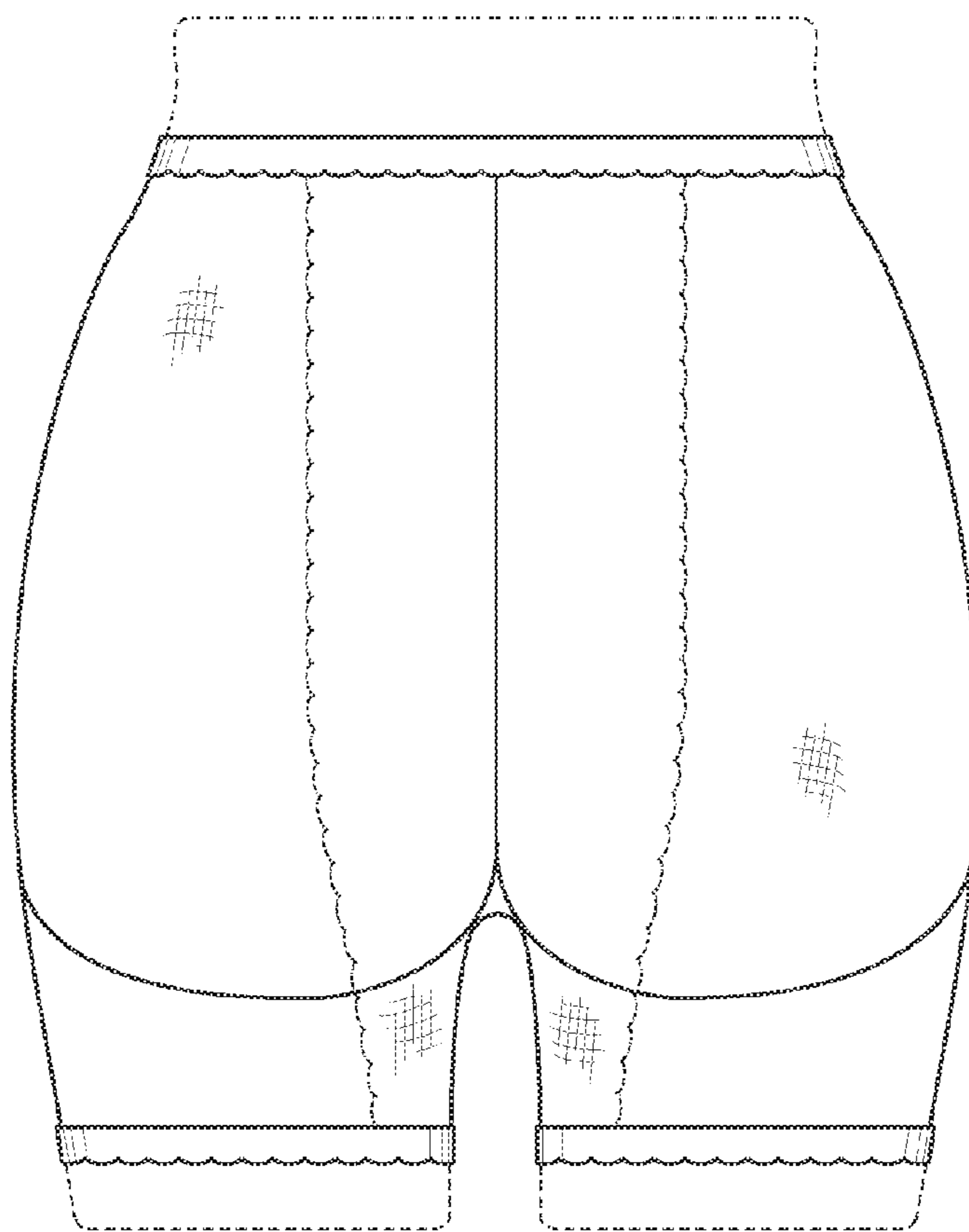

FIG. 12

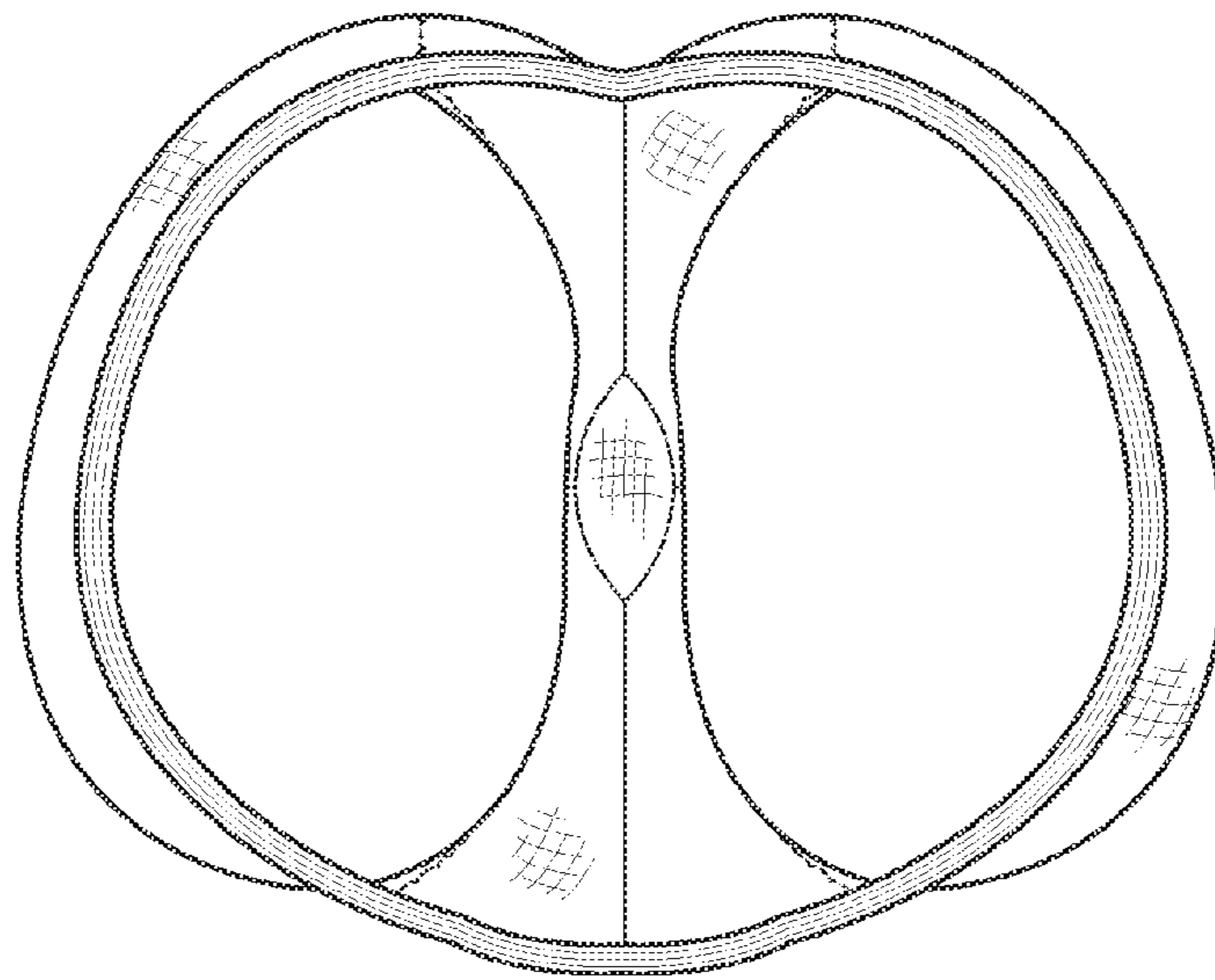

FIG. 13

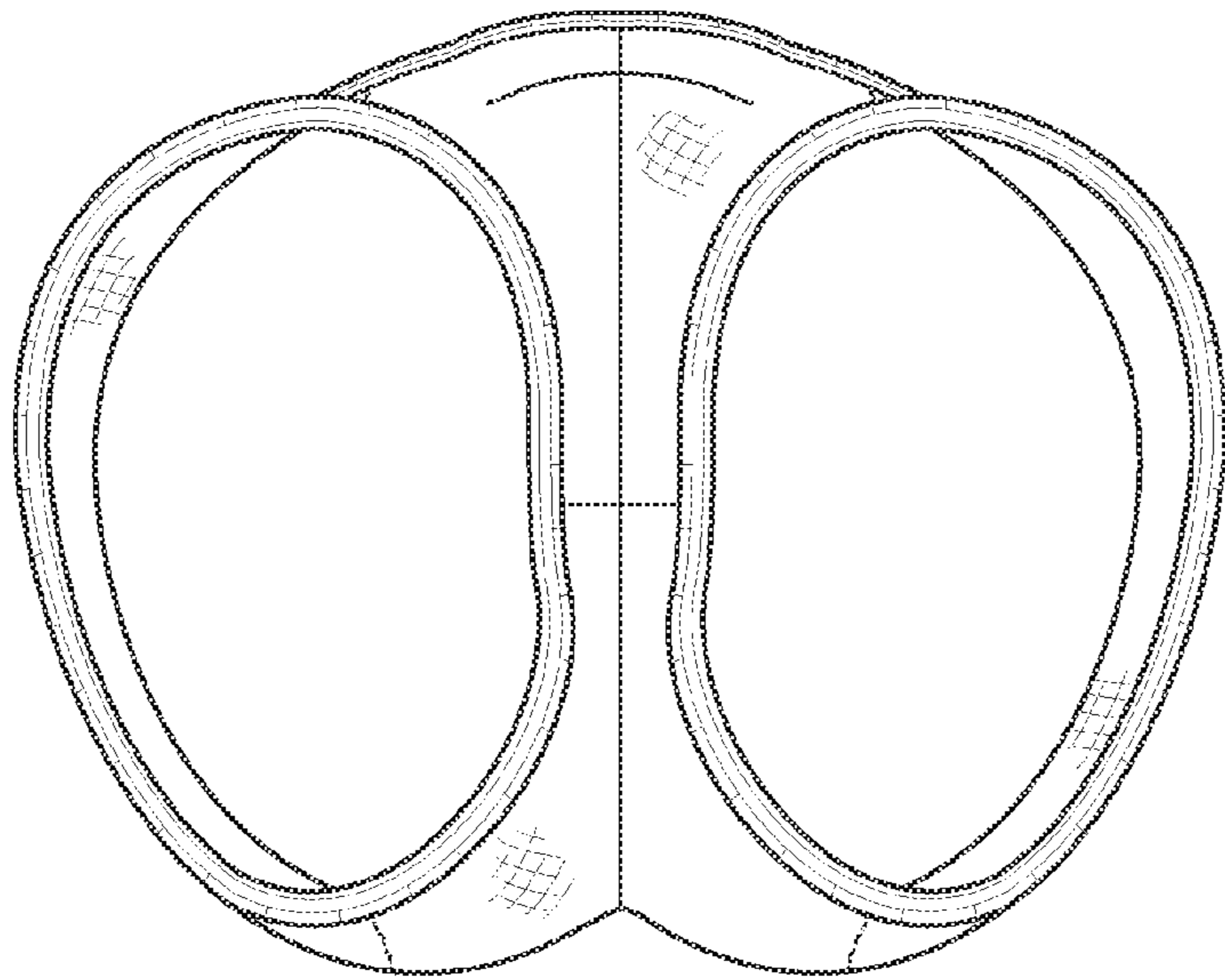

FIG. 14

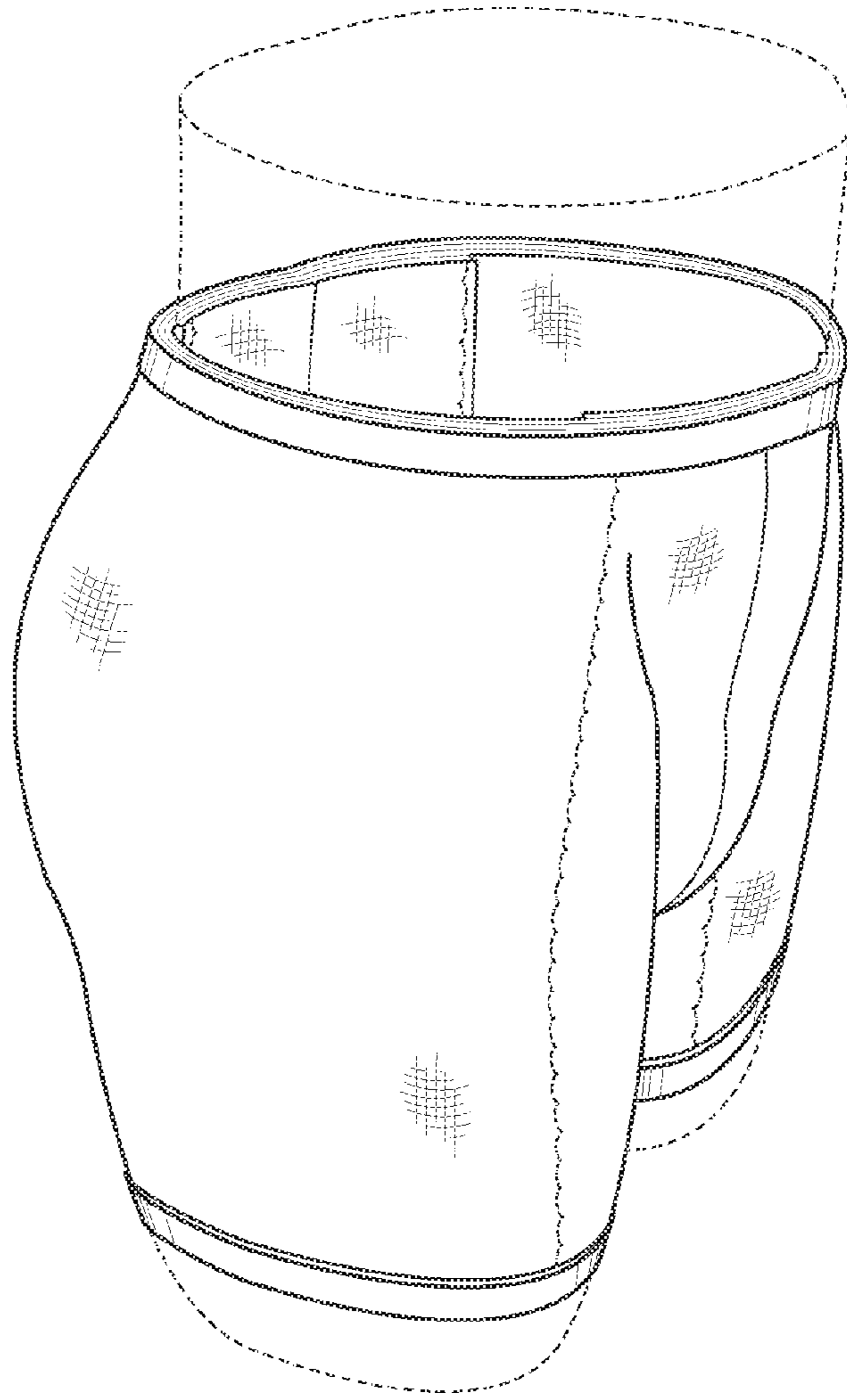

FIG. 15

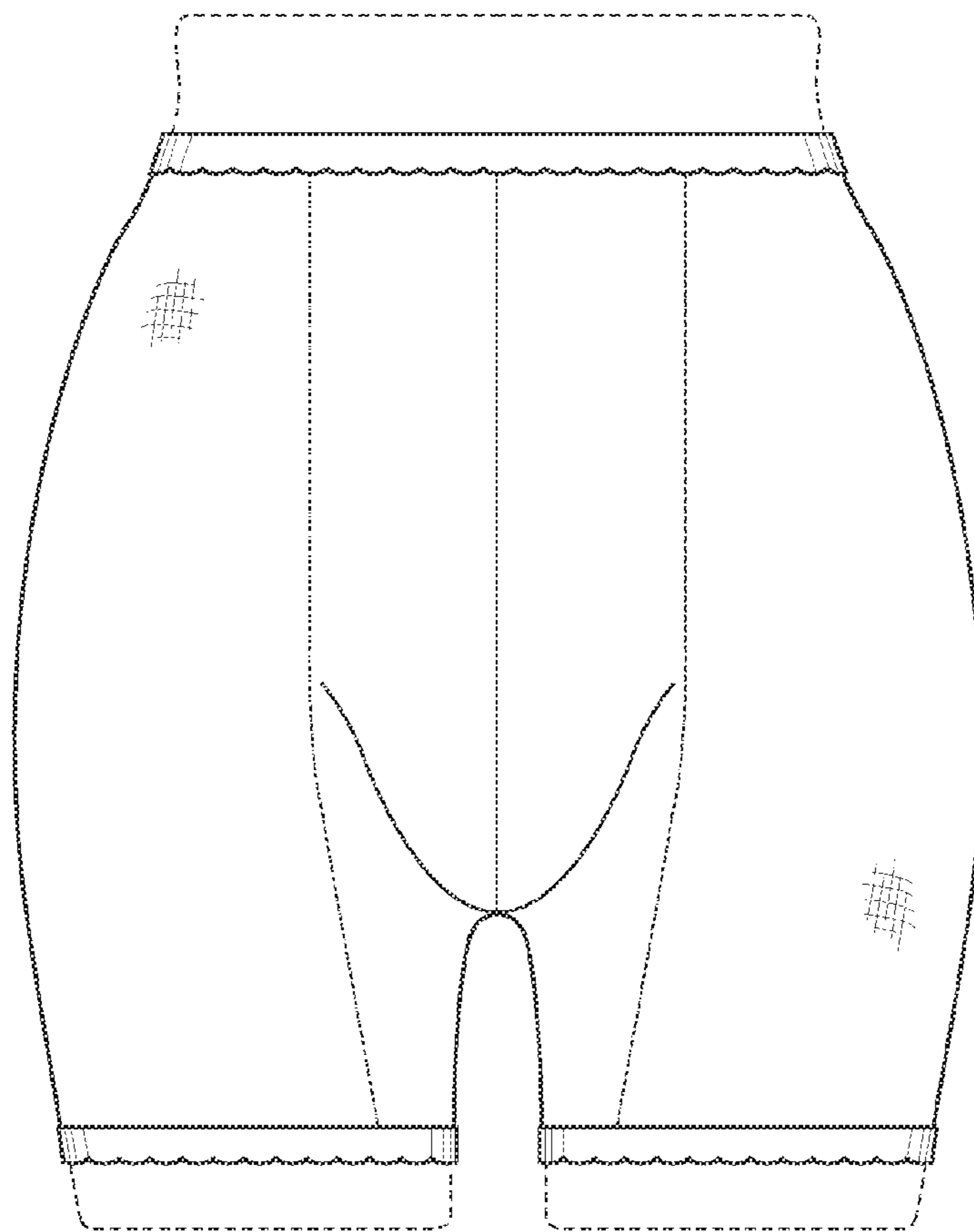

FIG. 16

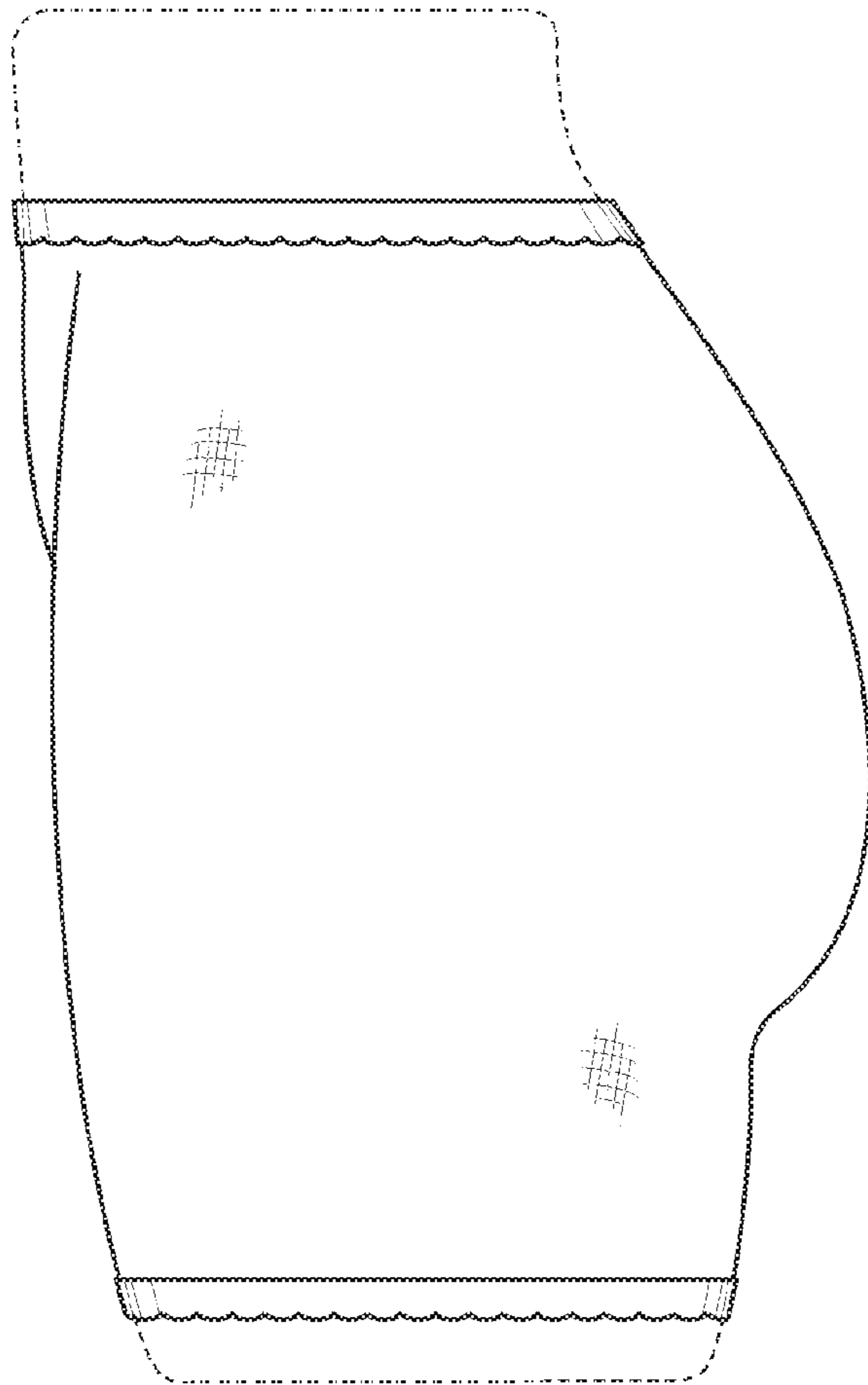

FIG. 17

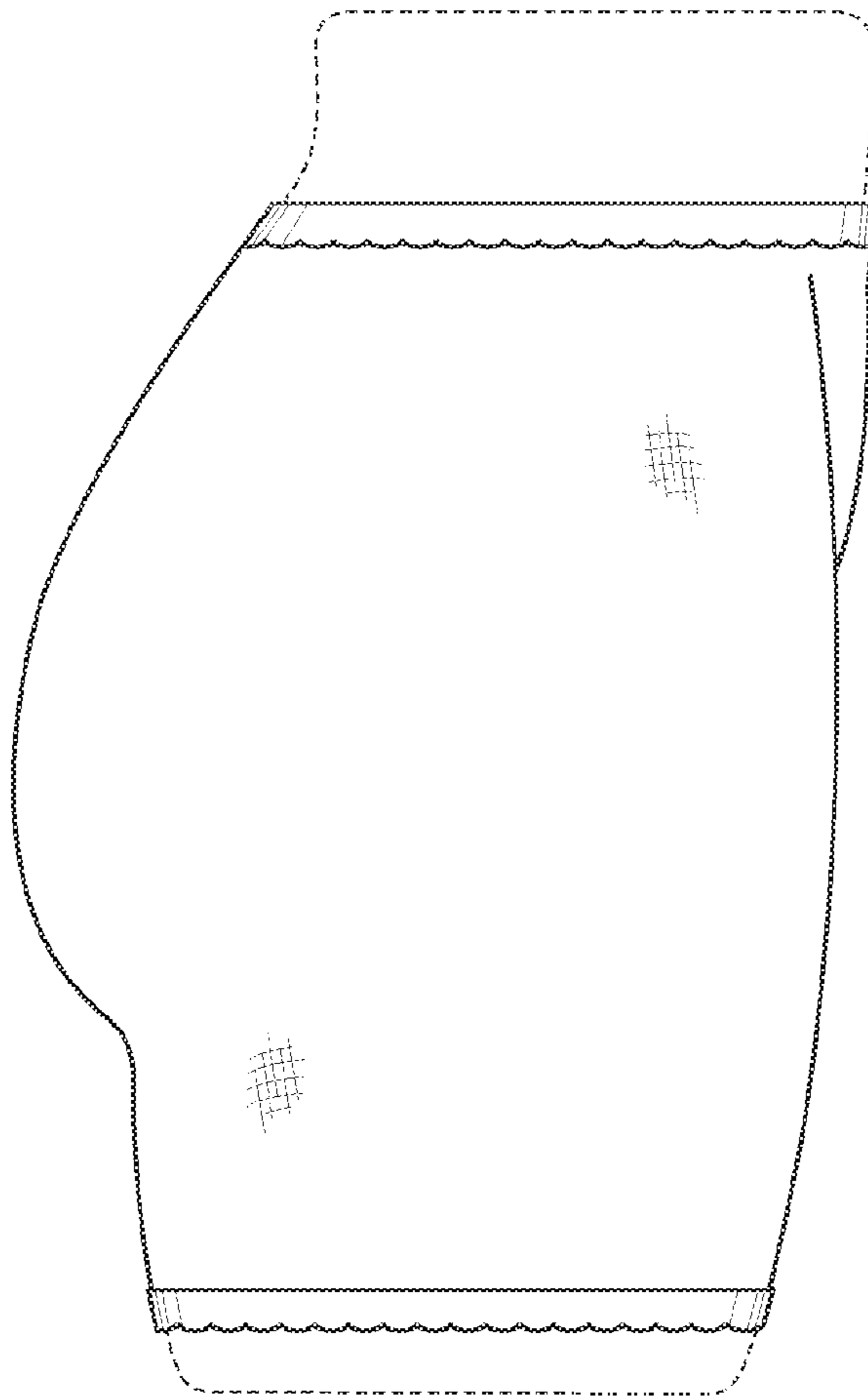

FIG. 18

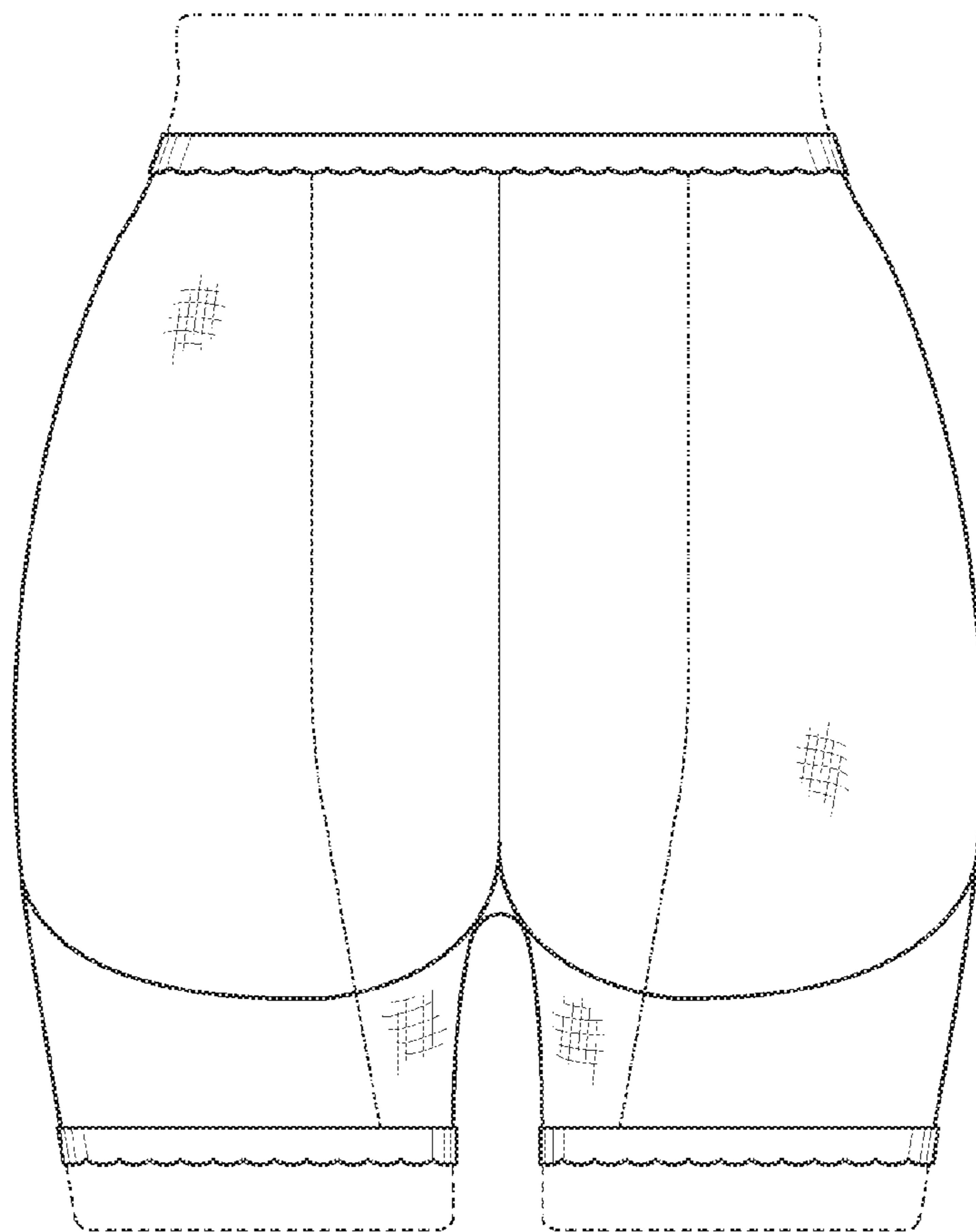

FIG. 19

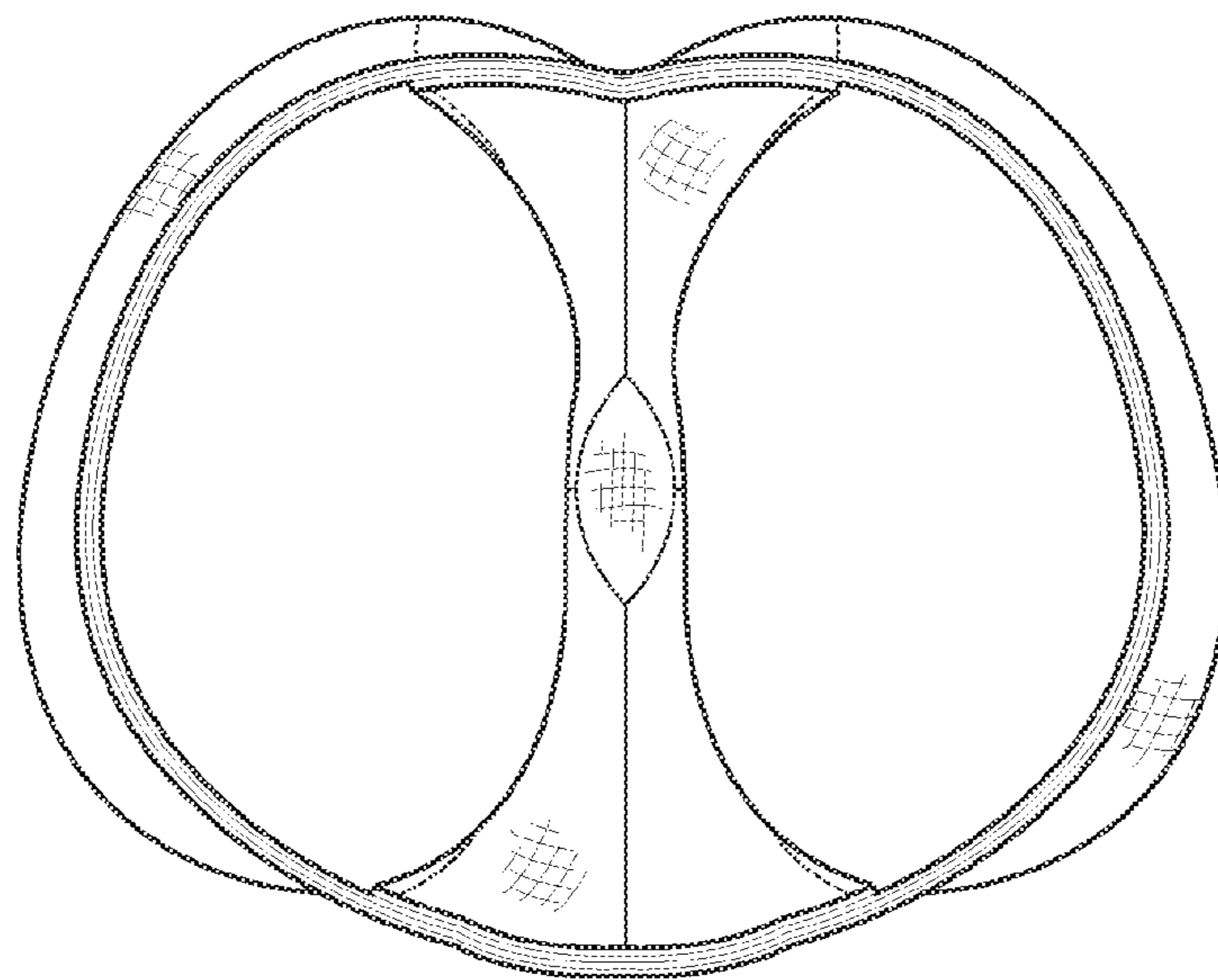

FIG. 20

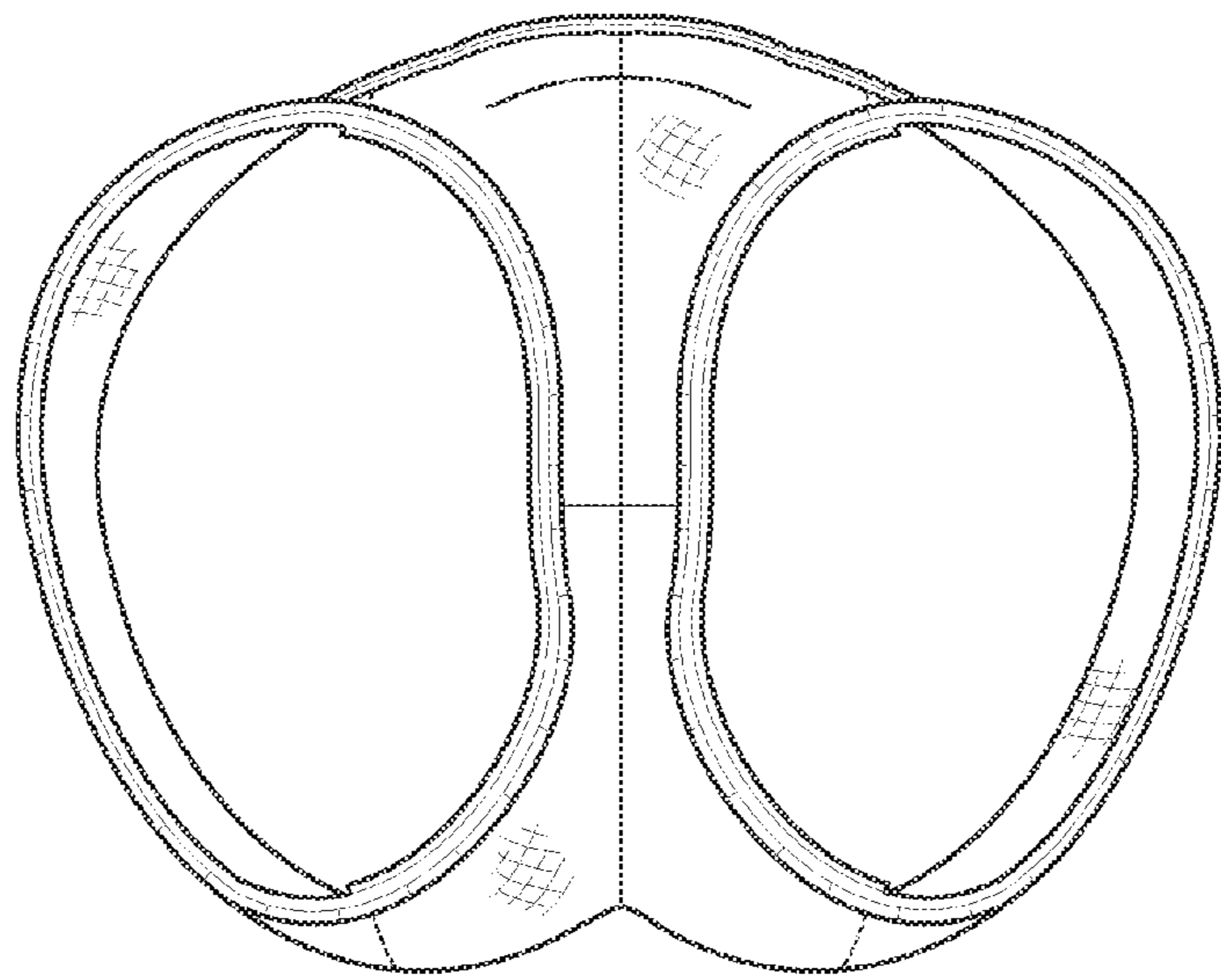

FIG. 21

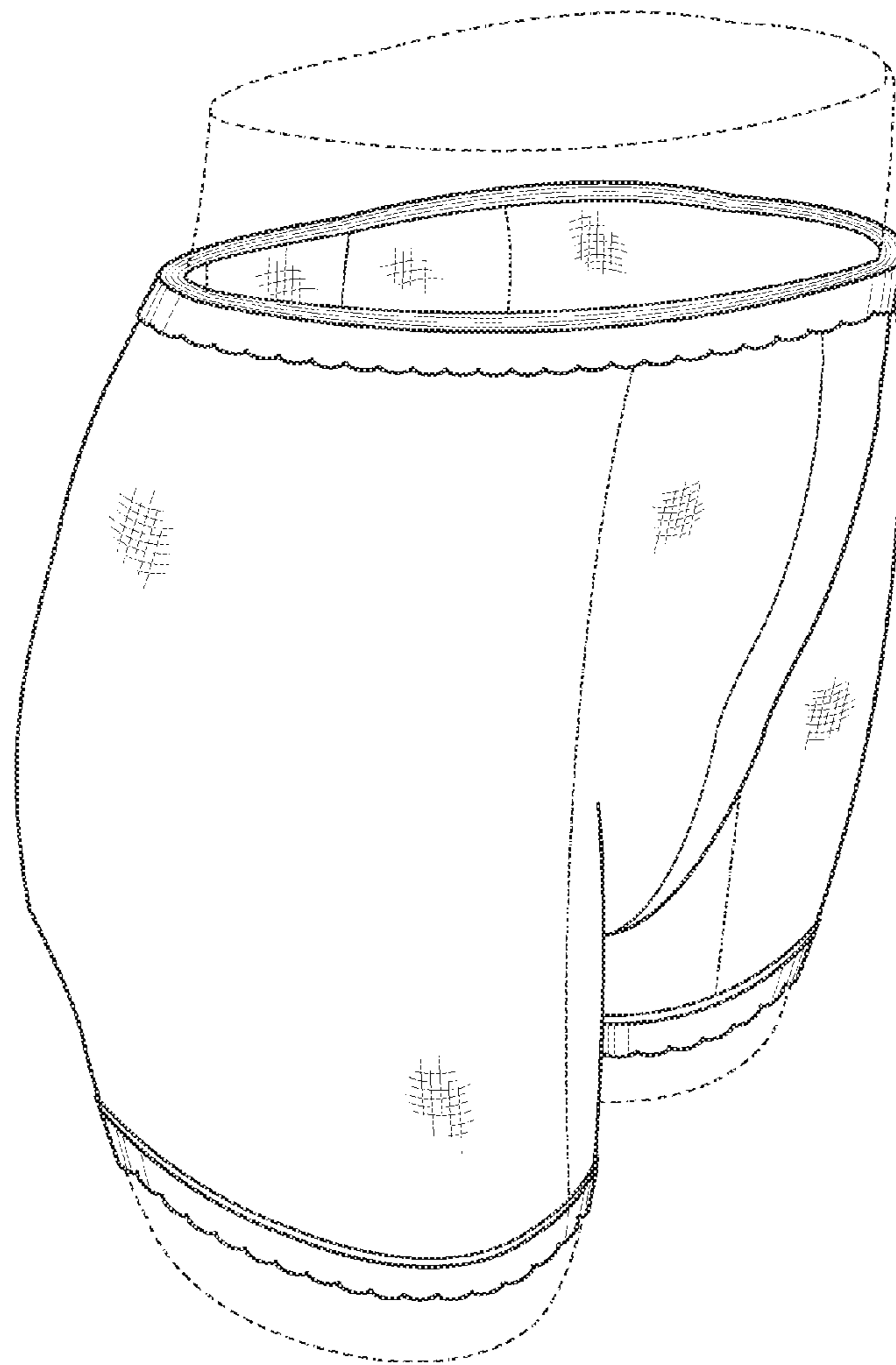

FIG. 22

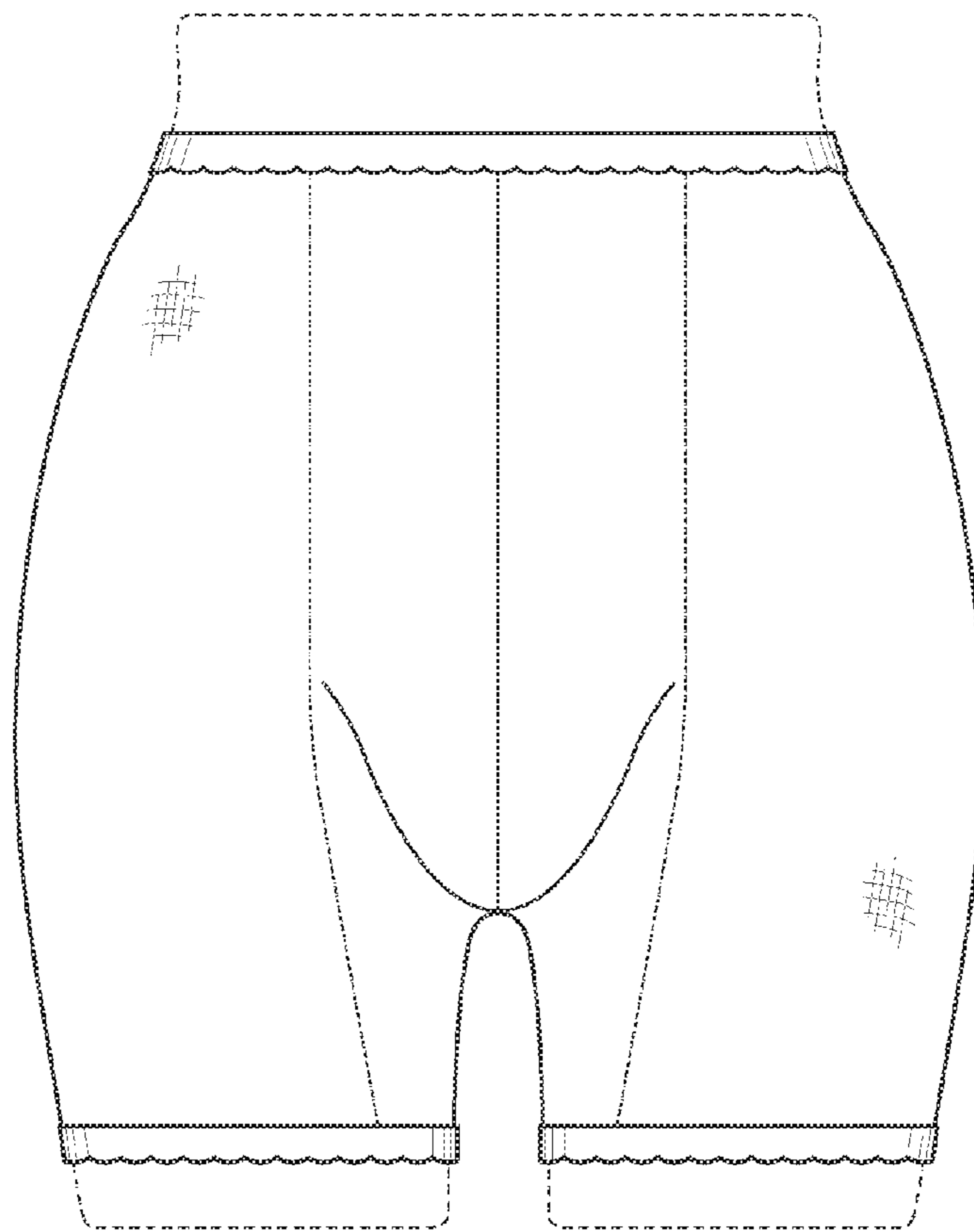

FIG. 23

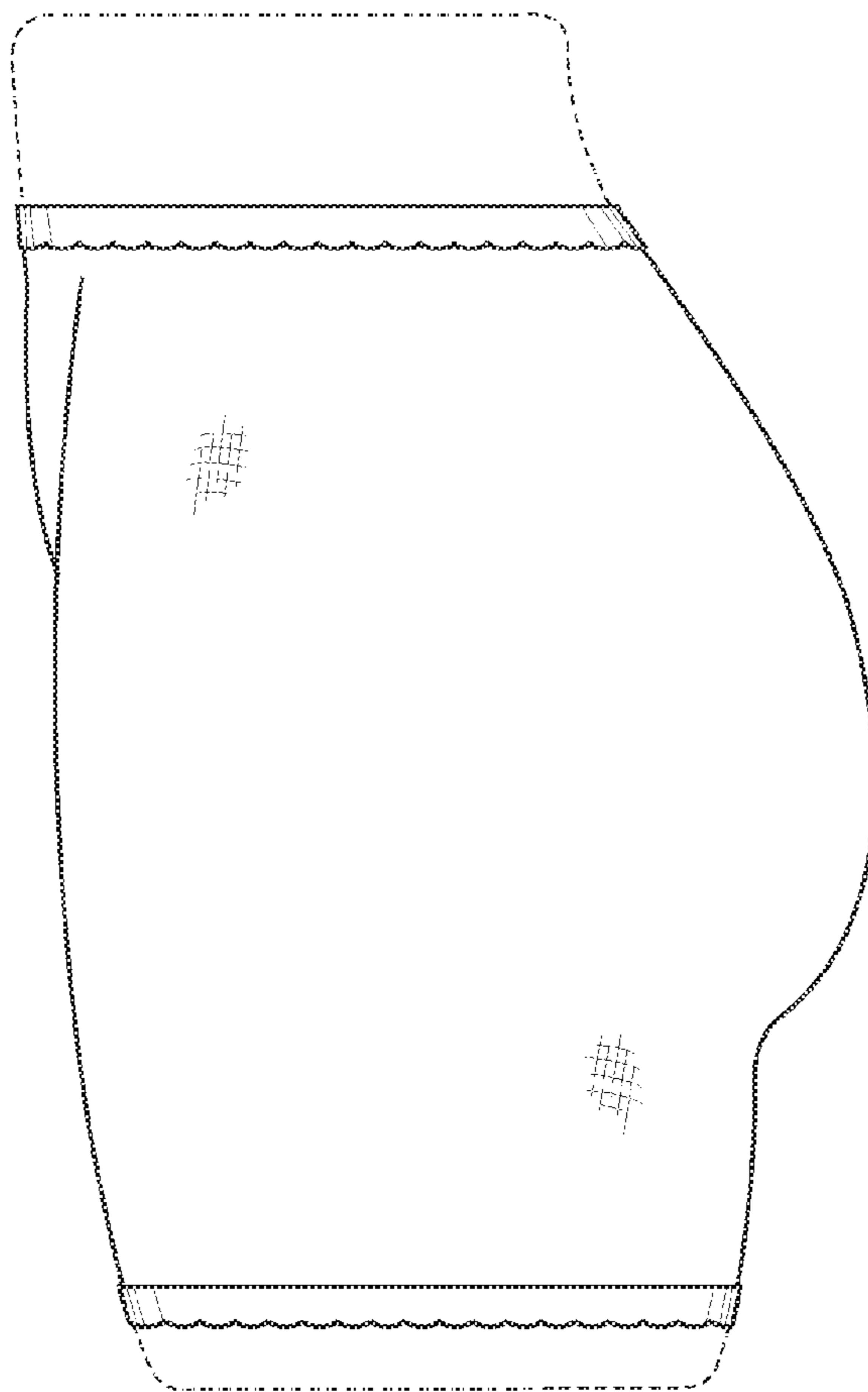

FIG. 24

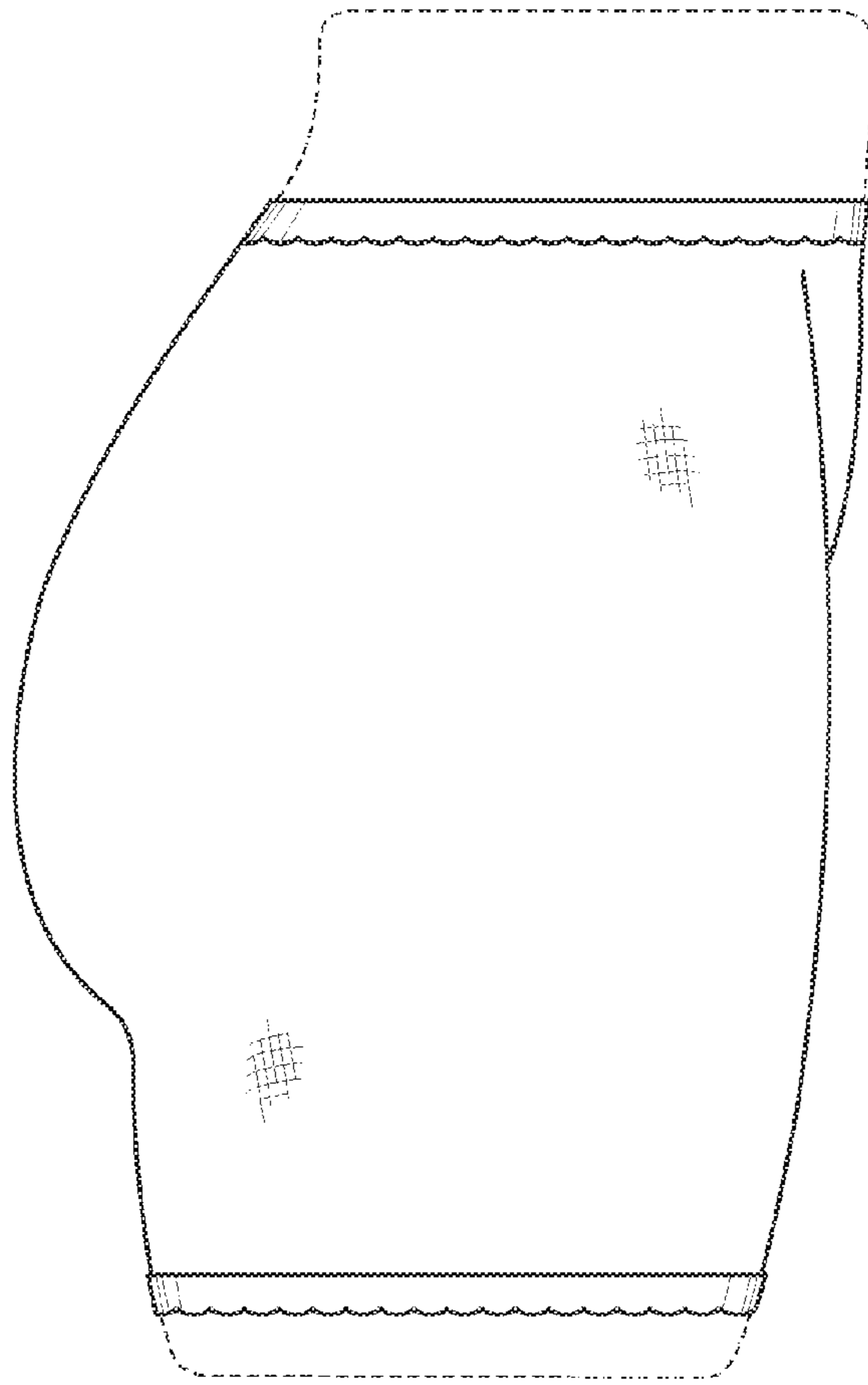

FIG. 25

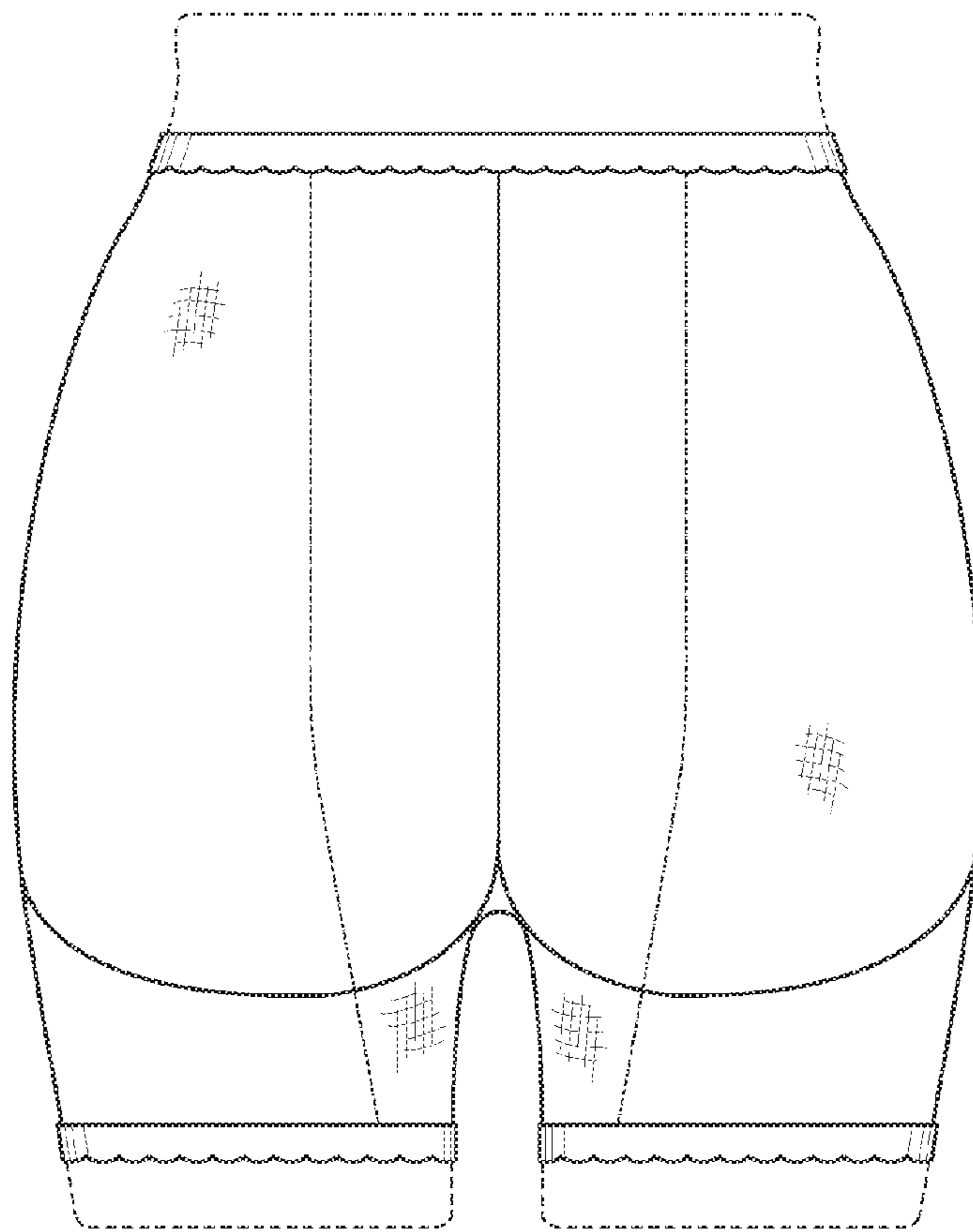

FIG. 26

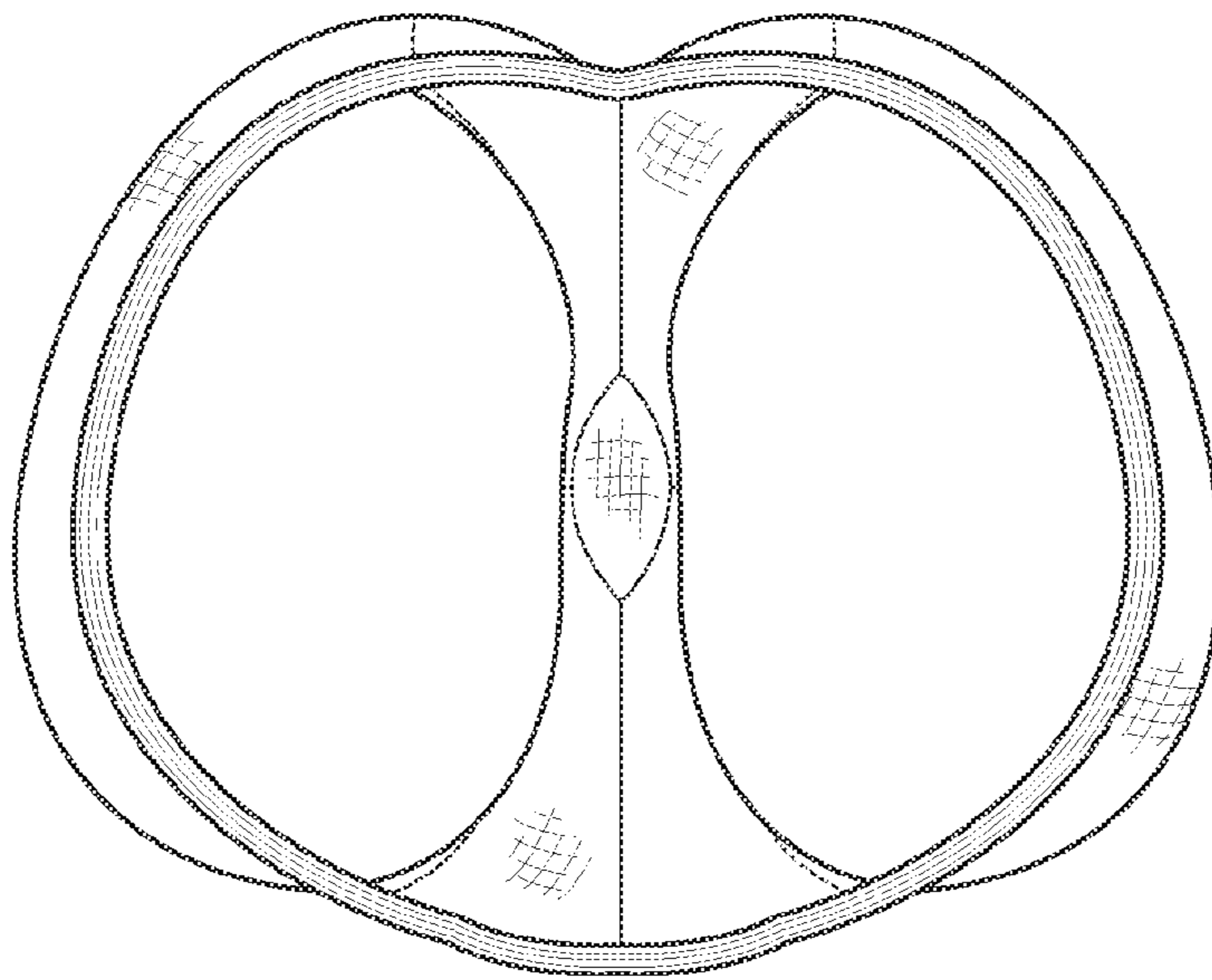

FIG. 27

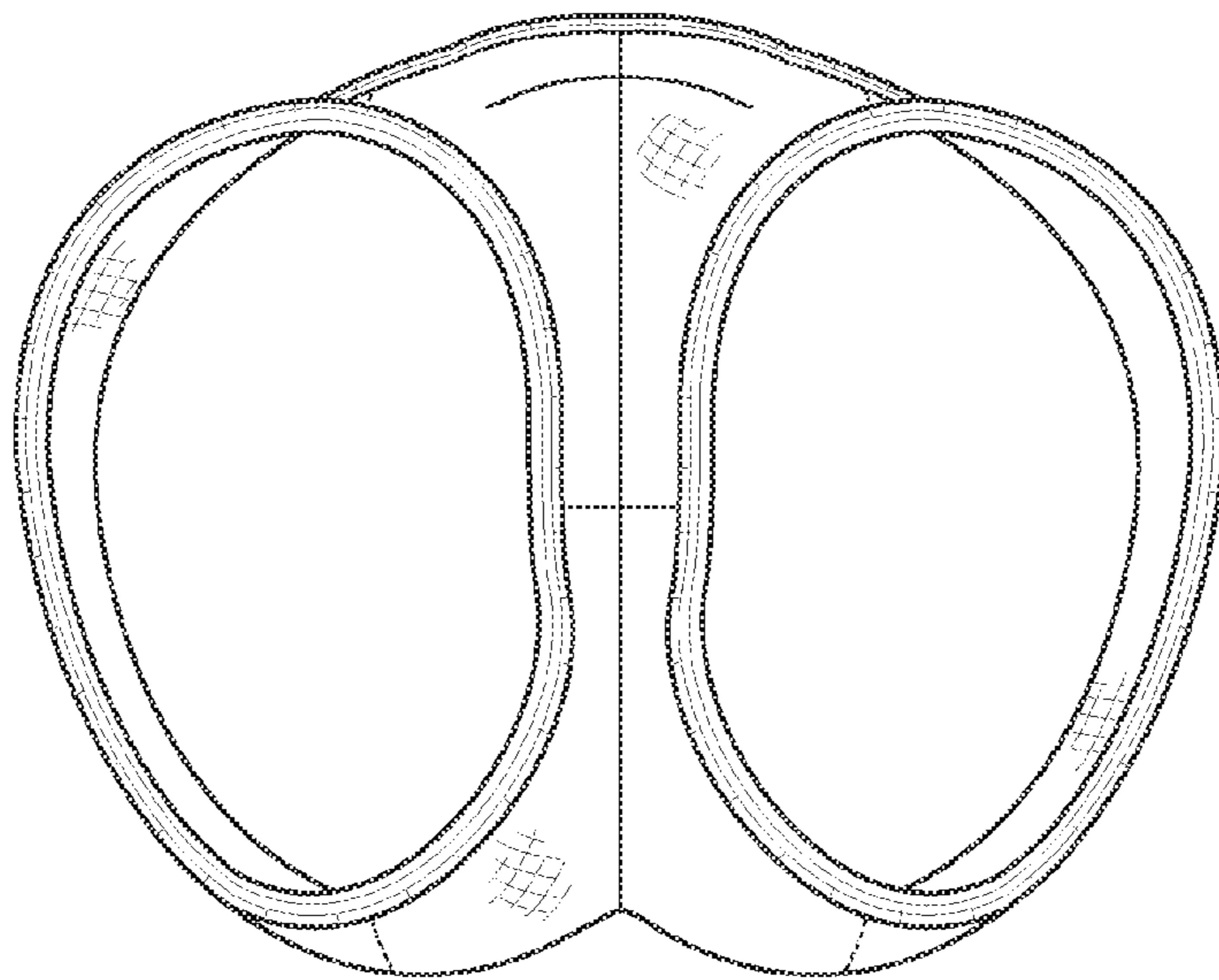

FIG. 28