



US00D692144S

(12) **United States Design Patent**
Lim

(10) **Patent No.:** **US D692,144 S**

(45) **Date of Patent:** **** Oct. 22, 2013**

(54) **CLIP FOR COVERING A TOOTH**

(71) Applicant: **Dong-Youn Lim**, Seoul (KR)

(72) Inventor: **Dong-Youn Lim**, Seoul (KR)

(**) Term: **14 Years**

(21) Appl. No.: **29/434,098**

(22) Filed: **Oct. 9, 2012**

(51) **LOC (9) Cl.** **24-01**

(52) **U.S. Cl.**
USPC **D24/176**; D19/90; D24/180

(58) **Field of Classification Search**
USPC D24/176, 180–181, 156; D19/65, 75,
D19/90; D7/601, 632; 433/35–36, 26, 40,
433/41, 116, 178, 191, 192, 202.1, 204,
433/213–214; 24/455, 531–532, 545–547;
211/11, 42, 126.13

See application file for complete search history.

(56) **References Cited**

U.S. PATENT DOCUMENTS

D182,443 S * 4/1958 Sherman D19/90
3,216,582 A * 11/1965 Cross D19/90
4,793,030 A * 12/1988 Hirsch 24/530
D344,588 S * 2/1994 Park D24/176

D350,008 S * 8/1994 Gaudet, Sr. D99/99
D421,272 S * 2/2000 Patel D19/90
D489,412 S * 5/2004 Hsu D19/75

* cited by examiner

Primary Examiner — Wan Laymon

(74) *Attorney, Agent, or Firm* — Edwards Wildman Palmer
LLP

(57) **CLAIM**

The ornamental design for a clip for covering a tooth, as shown and described.

DESCRIPTION

FIG. 1 is a perspective view of a clip for covering a tooth according to the present invention.

FIG. 2 is a front view of the clip for covering a tooth of FIG. 1.

FIG. 3 is a rear view of the clip for covering a tooth of FIG. 1.

FIG. 4 is a left side view of the clip for covering a tooth of FIG. 1.

FIG. 5 is a top view of the clip for covering a tooth of FIG. 1; and,

FIG. 6 is a bottom view of the clip for covering a tooth of FIG. 1.

A right side view thereof is omitted since it is a mirror image of the left side view.

1 Claim, 6 Drawing Sheets

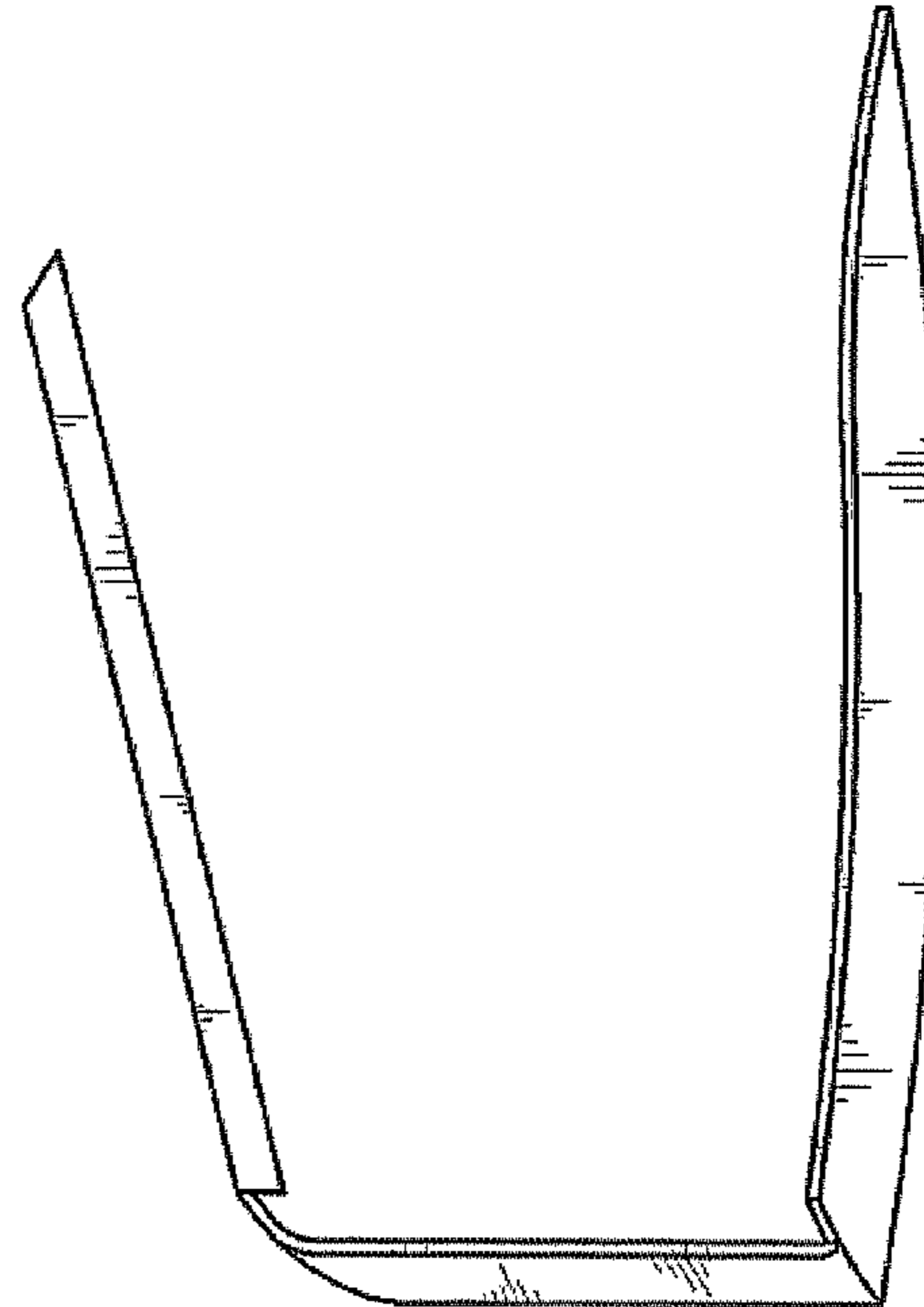
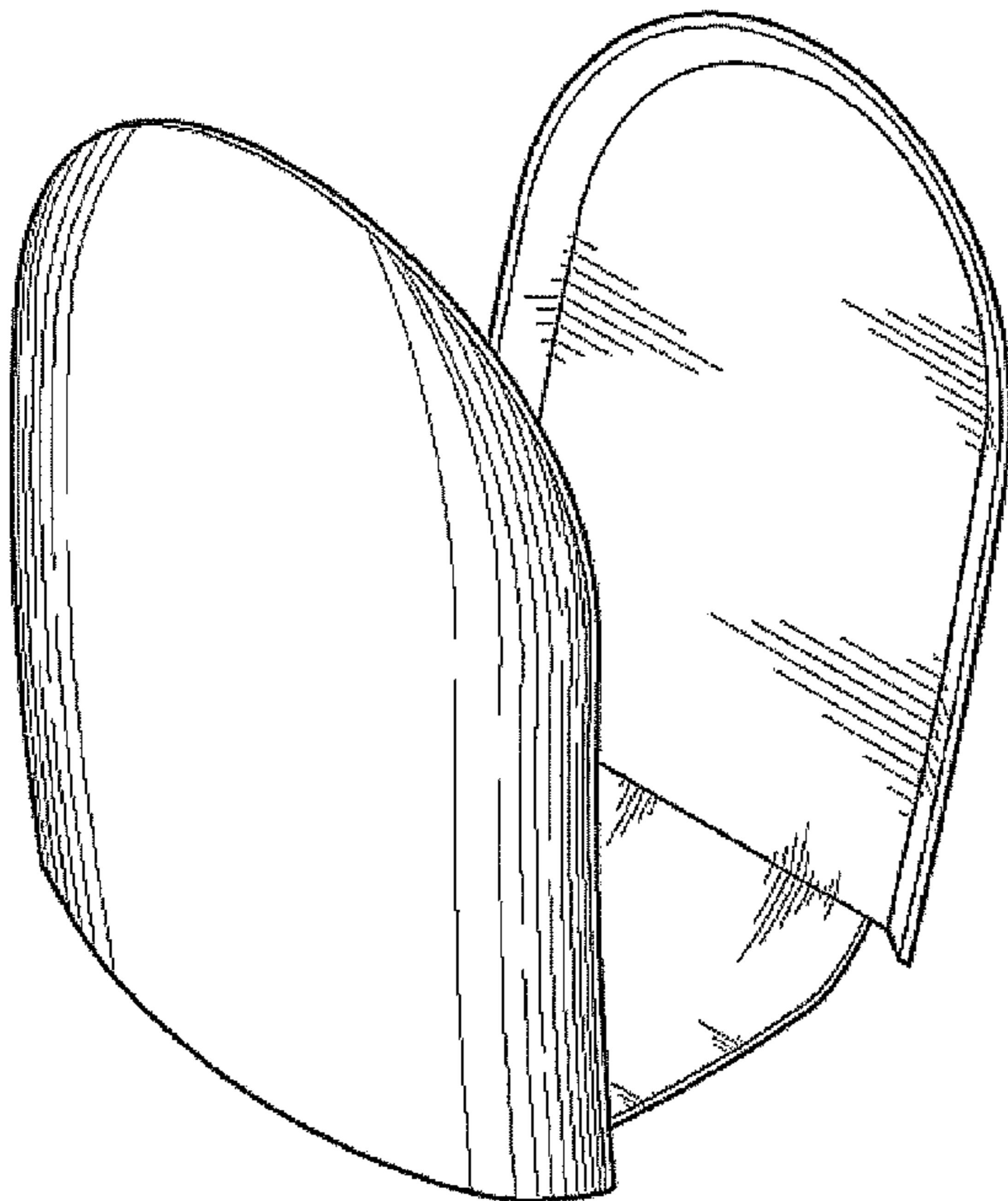

FIG. 1

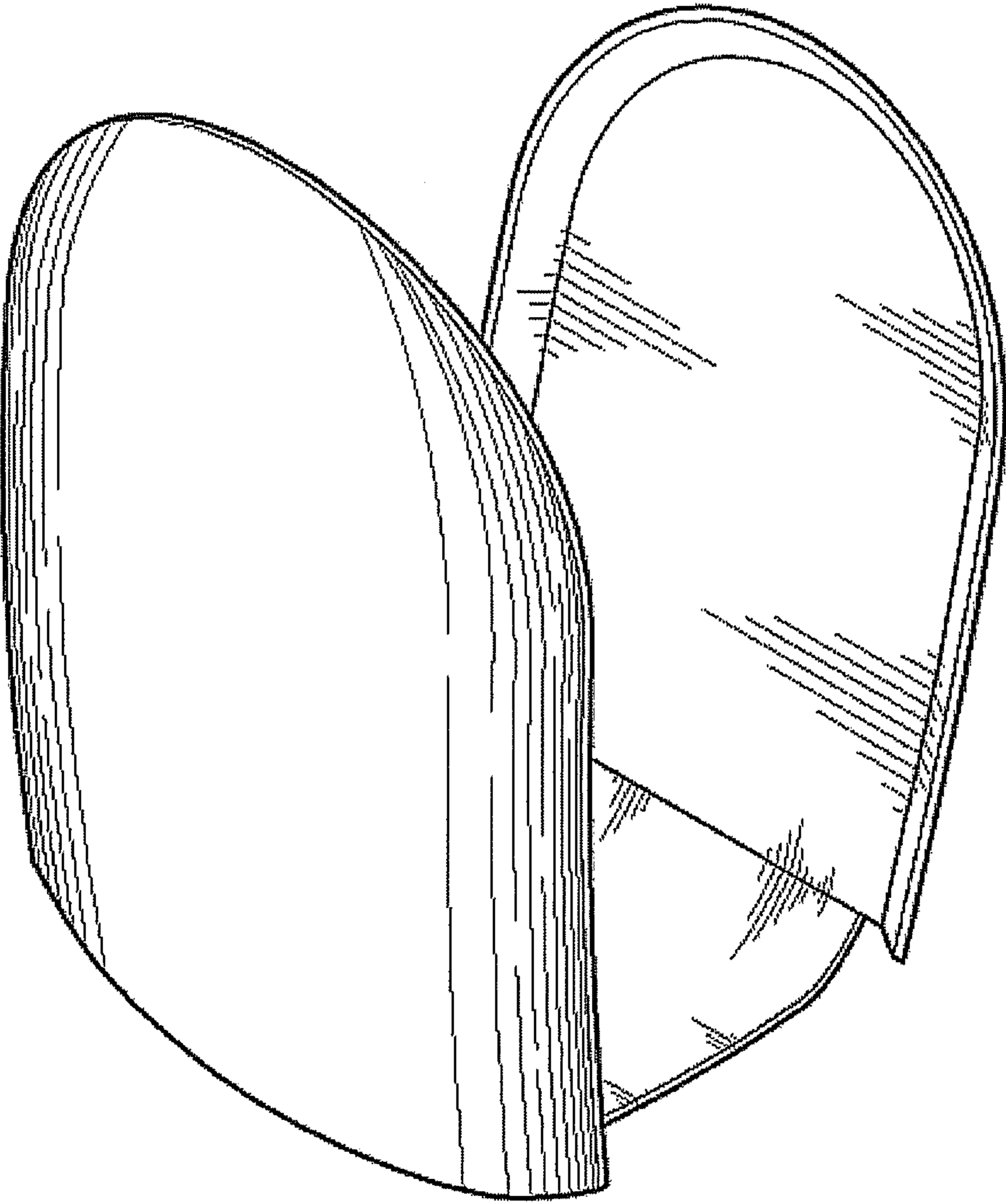

FIG. 2

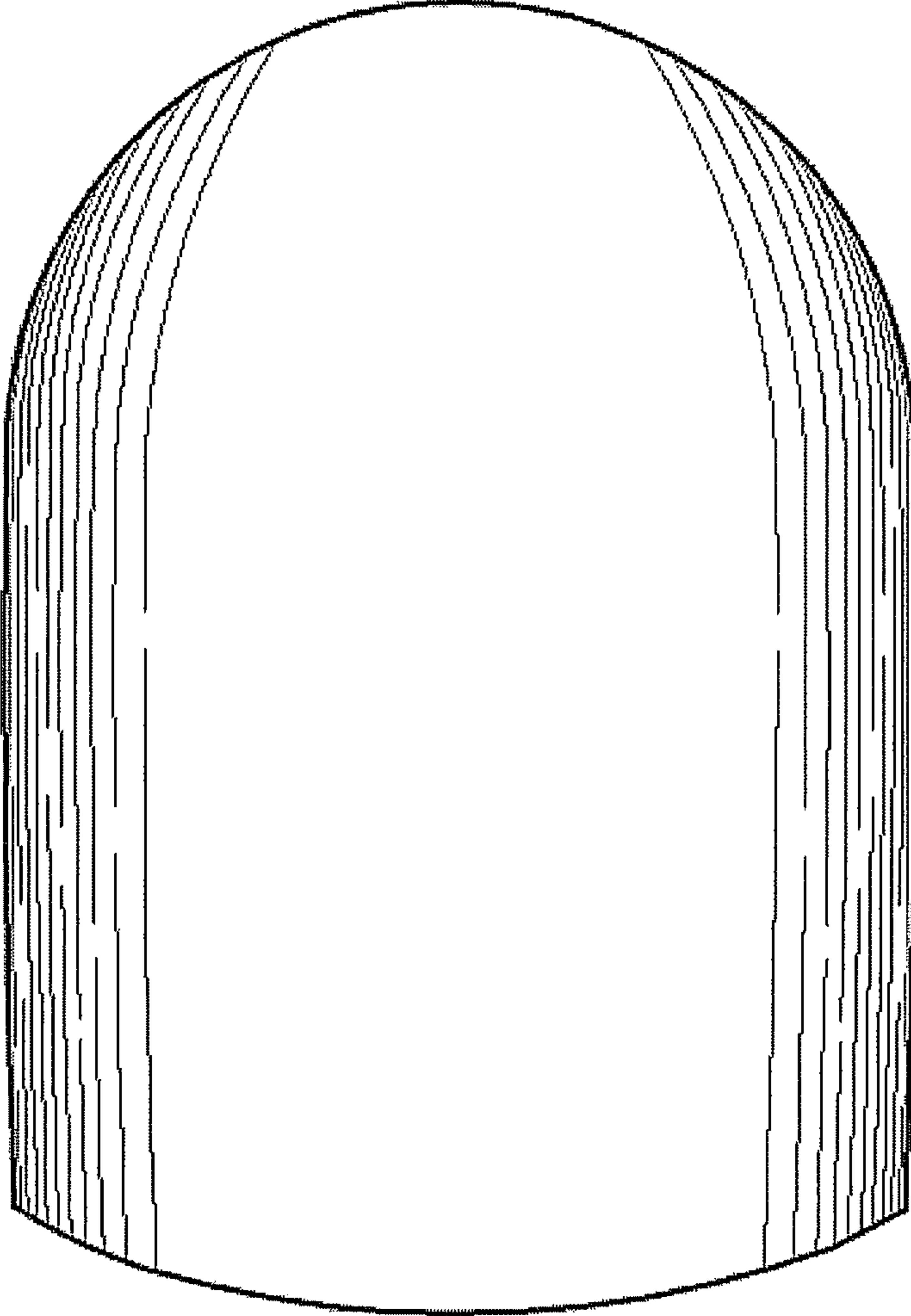

FIG. 3

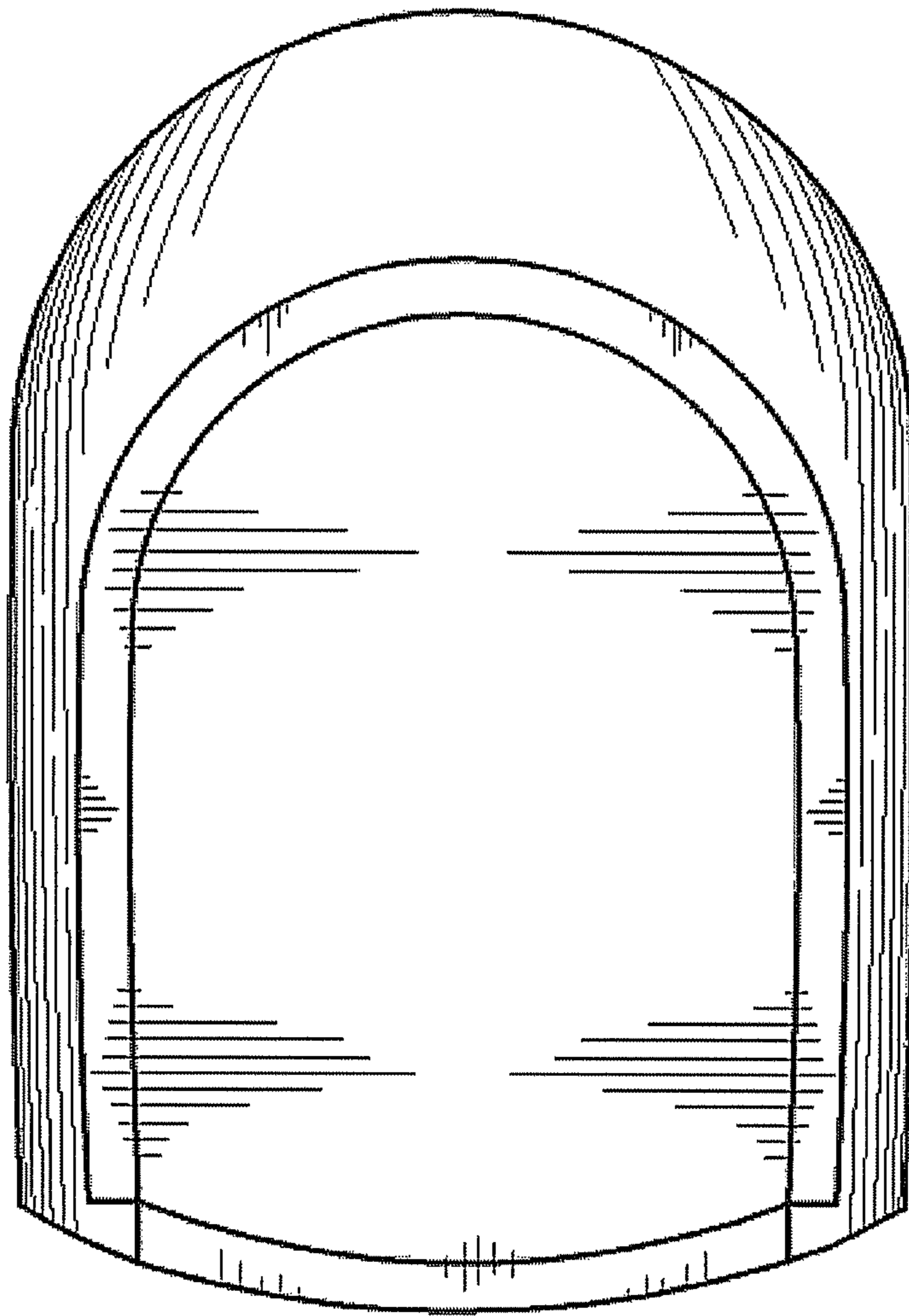

FIG. 4

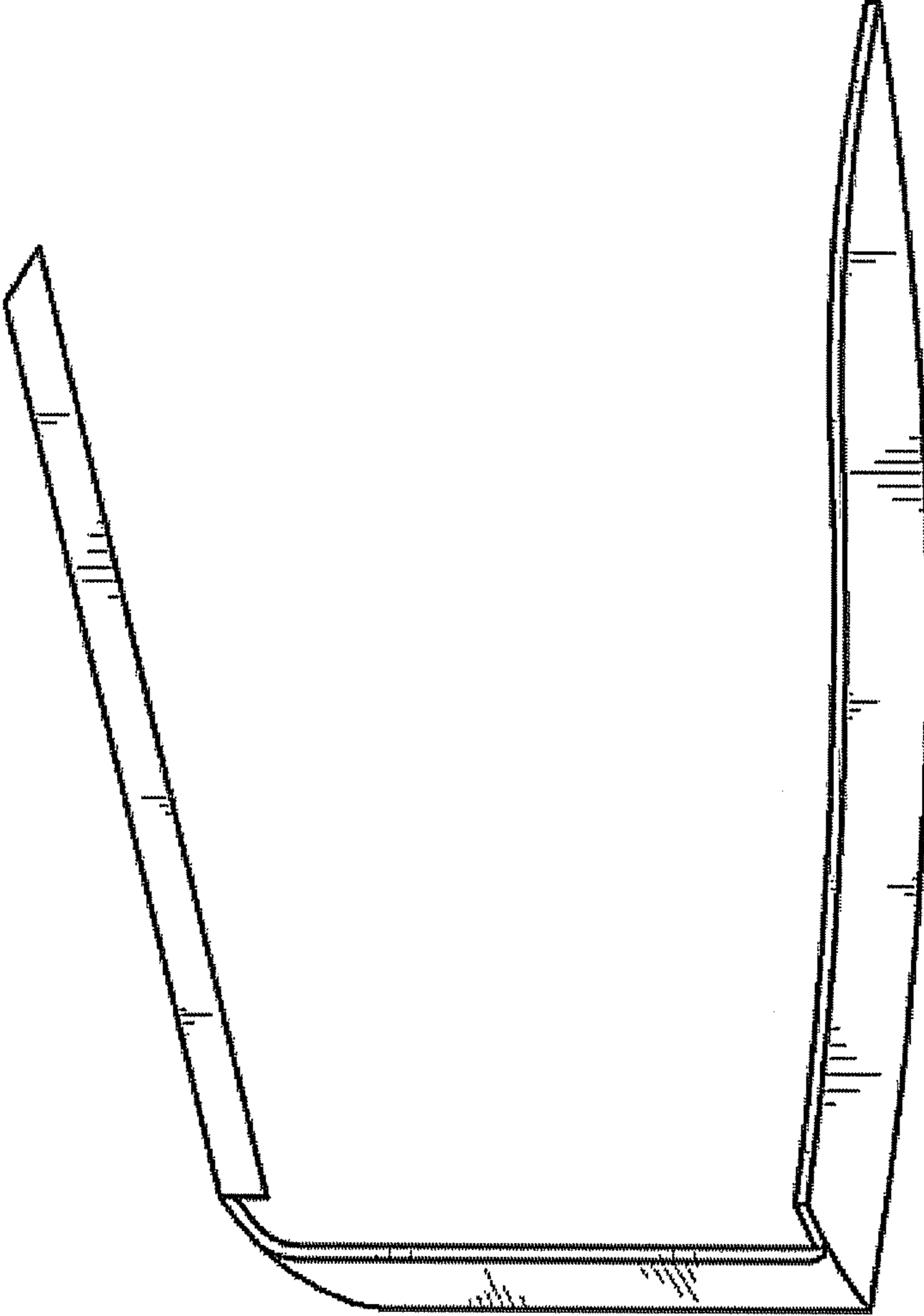

FIG. 5

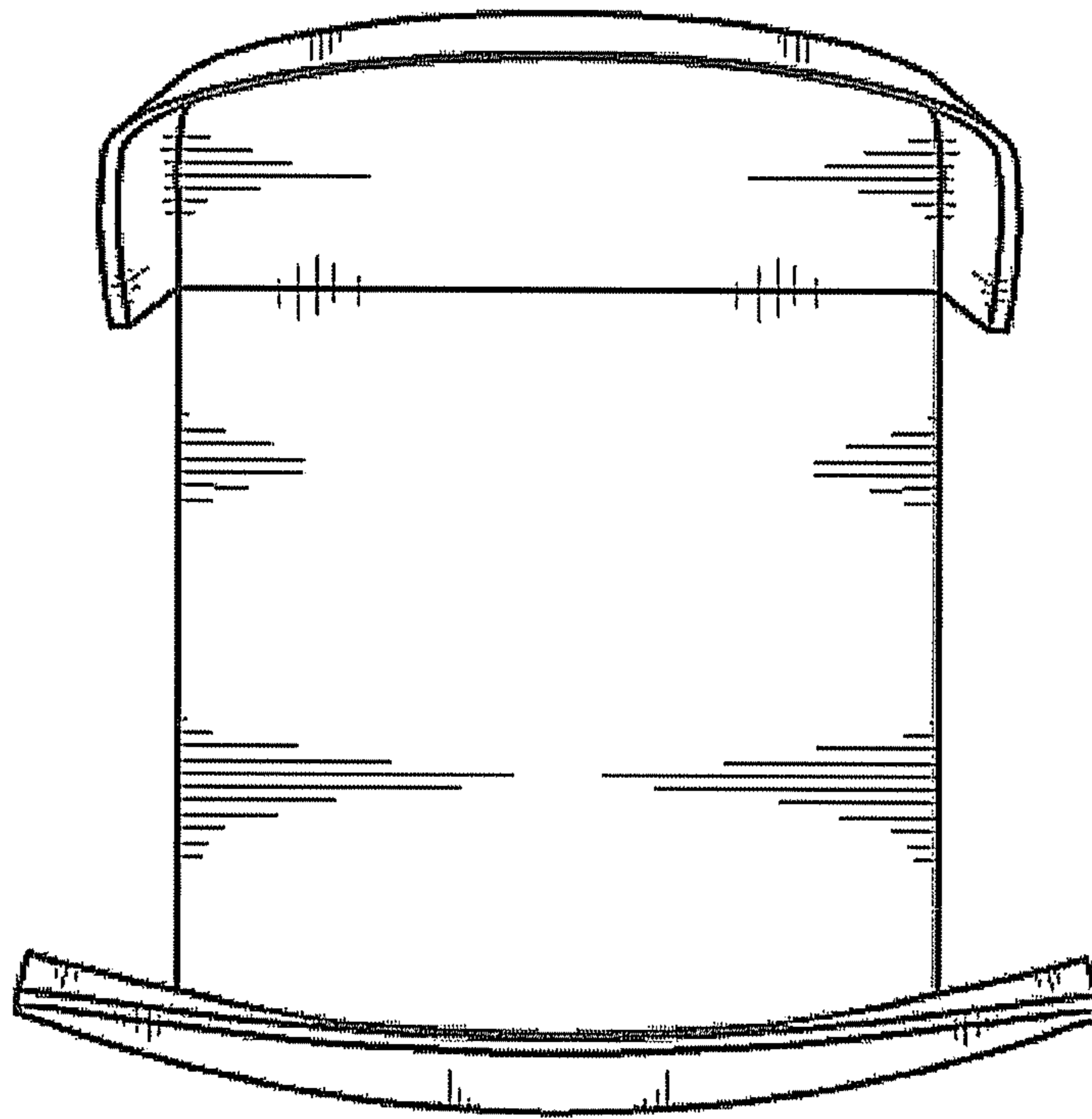

FIG. 6

