



US00D692122S

(12) **United States Design Patent**  
**von Hollen et al.**

(10) **Patent No.:** **US D692,122 S**

(45) **Date of Patent:** **\*\* Oct. 22, 2013**

(54) **HOLDING CHAMBER FOR FACE MASK**

(56) **References Cited**

(75) Inventors: **Dirk Ernest von Hollen**, Clark, NJ  
(US); **Eric Andrew Lieberman**, Scotch  
Plains, NJ (US); **Ashwin Kumar**  
**Viswanath**, Randolph, NJ (US); **Robert**  
**Koshinski**, Cranford, NJ (US); **Donald**  
**Fraser van Royen**, New York, NY (US)

U.S. PATENT DOCUMENTS

6,435,176	B1 *	8/2002	Berg et al. ....	128/200.23
D504,620	S *	5/2005	Kazuo et al. ....	D9/685
D511,210	S *	11/2005	Cardona Burrull .....	D24/110.5
7,404,400	B2 *	7/2008	Lulla et al. ....	128/200.14
7,748,385	B2 *	7/2010	Lieberman et al. ....	128/207.12
2006/0185675	A1 *	8/2006	Colin .....	128/206.24
2008/0035142	A1 *	2/2008	Lulla et al. ....	128/203.12
2008/0210225	A1 *	9/2008	Geiger .....	128/200.14

(73) Assignee: **Koninklijke Philips N.V.**, Eindhoven  
(NL)

\* cited by examiner

(\*\*) Term: **14 Years**

*Primary Examiner* — Ian Simmons

*Assistant Examiner* — Richelle Shelton

(21) Appl. No.: **29/403,880**

(74) *Attorney, Agent, or Firm* — Timothy A. Nathan

(22) Filed: **Oct. 12, 2011**

(57) **CLAIM**

The ornamental design for a holding chamber for face mask,  
as shown and described.

(30) **Foreign Application Priority Data**

**DESCRIPTION**

Apr. 13, 2011 (EM) ..... 001850421-0004

(51) **LOC (9) Cl.** ..... **29-02**

(52) **U.S. Cl.**  
USPC ..... **D24/110**

(58) **Field of Classification Search**  
USPC ..... D24/110, 110.1-110.5; 128/200.14,  
128/200.23

FIG. 1 is a perspective view showing our new design;  
FIG. 2 is a front elevational view thereof;  
FIG. 3 is a rear elevational view thereof;  
FIG. 4 is a left side elevational view thereof;  
FIG. 5 is a right side elevational view thereof;  
FIG. 6 is a top plan view thereof; and,  
FIG. 7 is a bottom plan view thereof.  
The broken lines illustrate portions of the holding chamber  
for face mask which form no part of the claimed design.

See application file for complete search history.

**1 Claim, 4 Drawing Sheets**

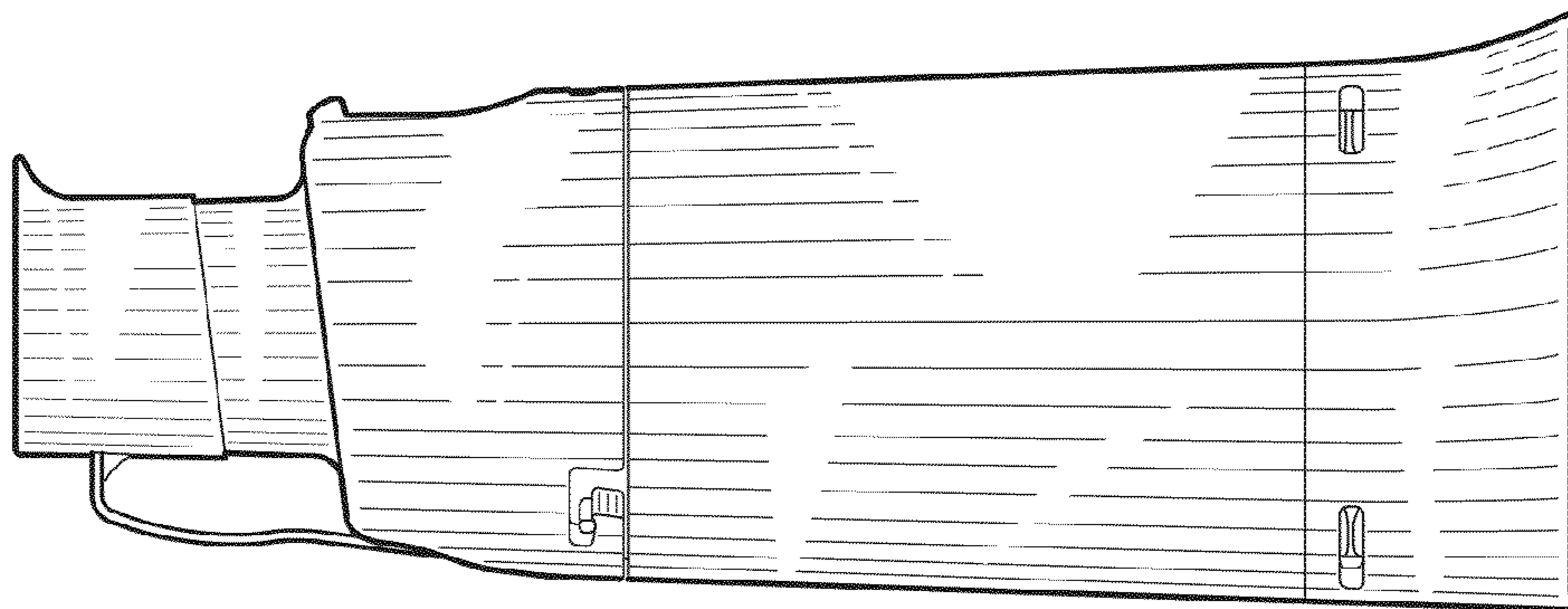

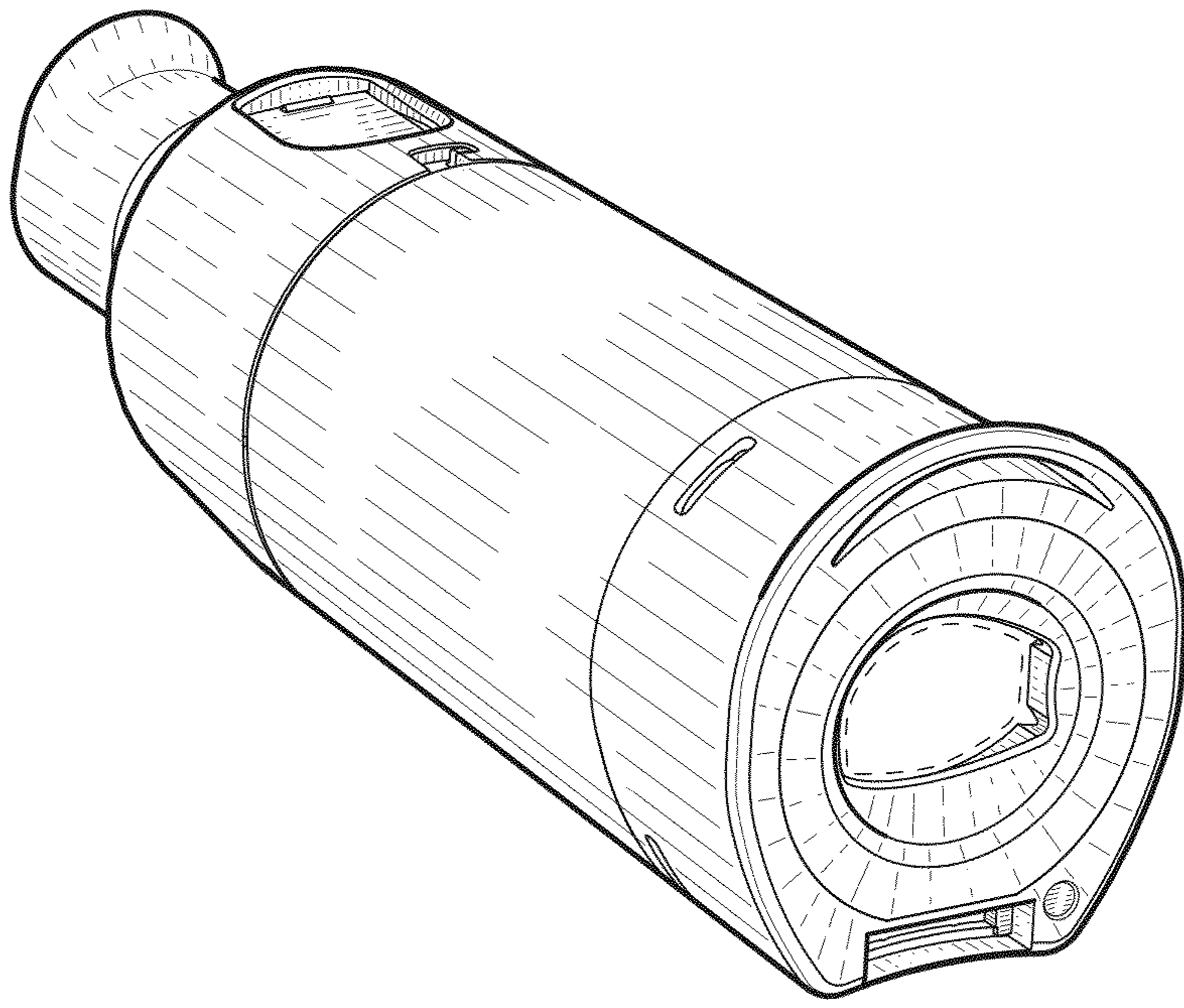

FIG. 1

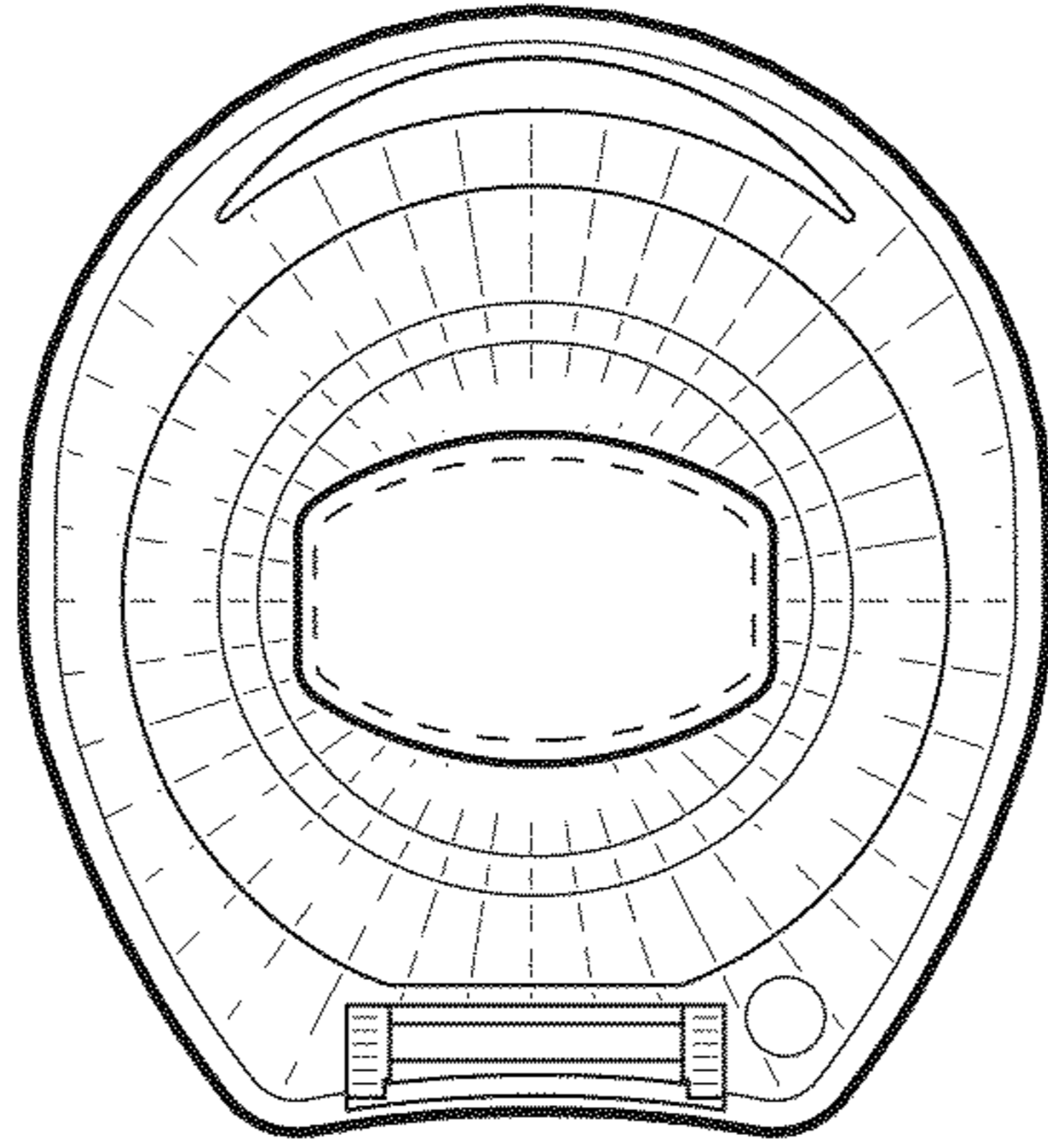

FIG. 2

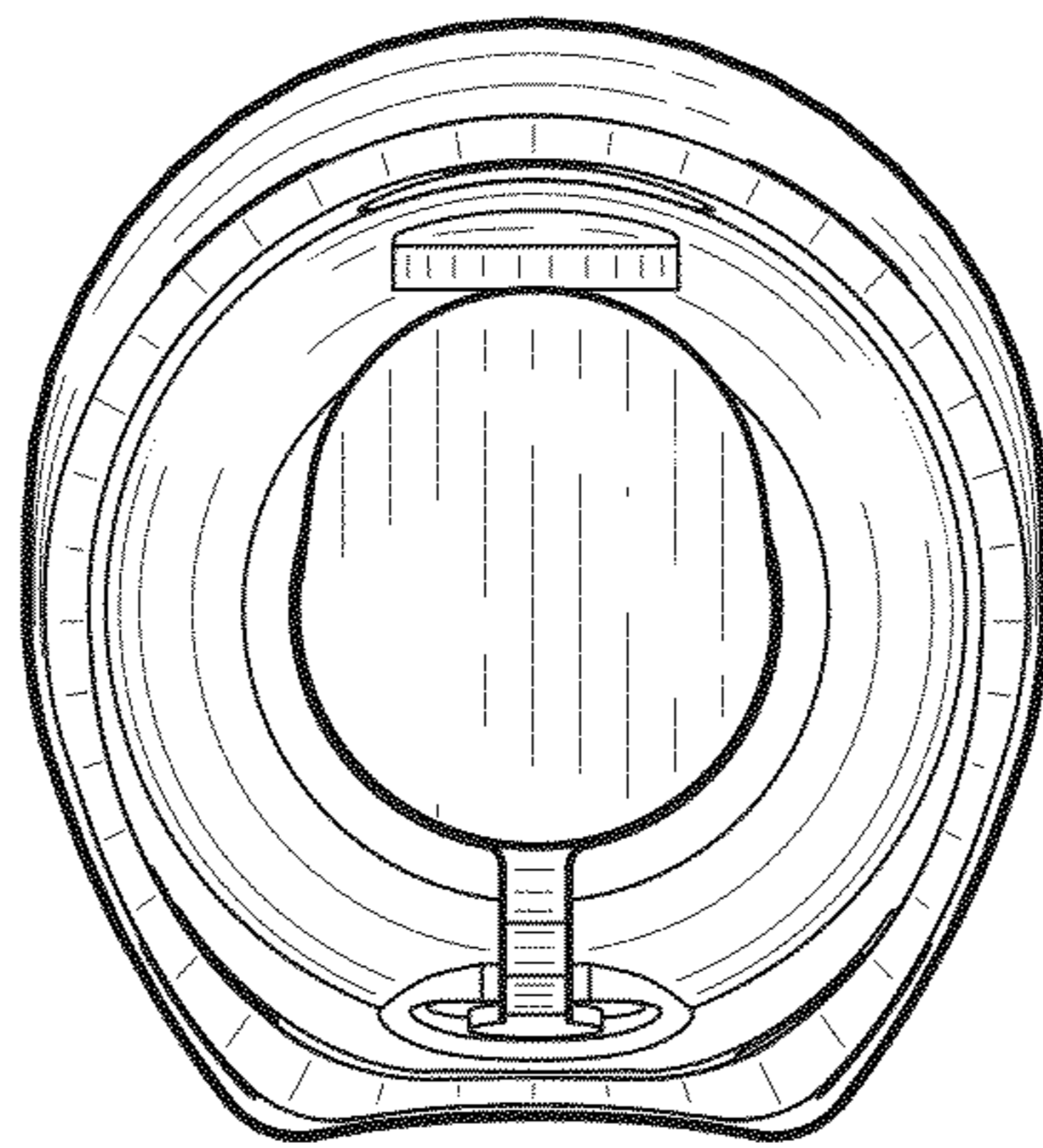

FIG. 3

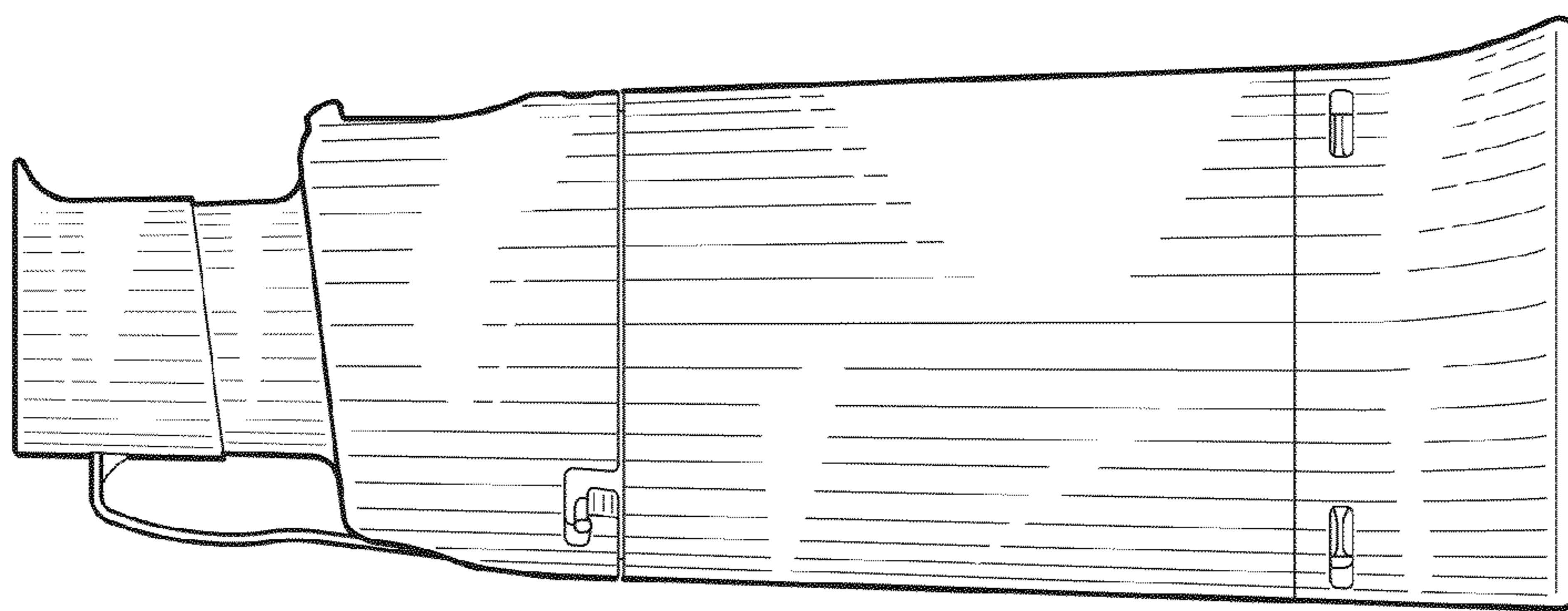

FIG. 4

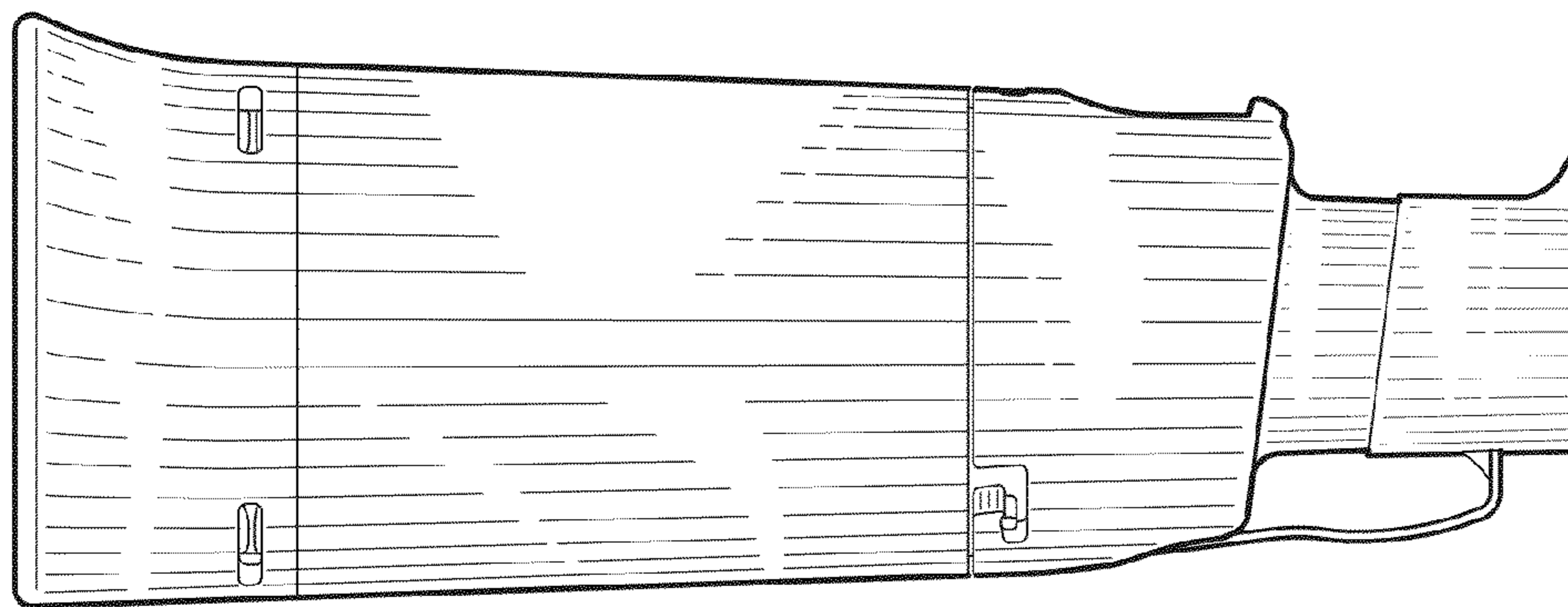

FIG. 5

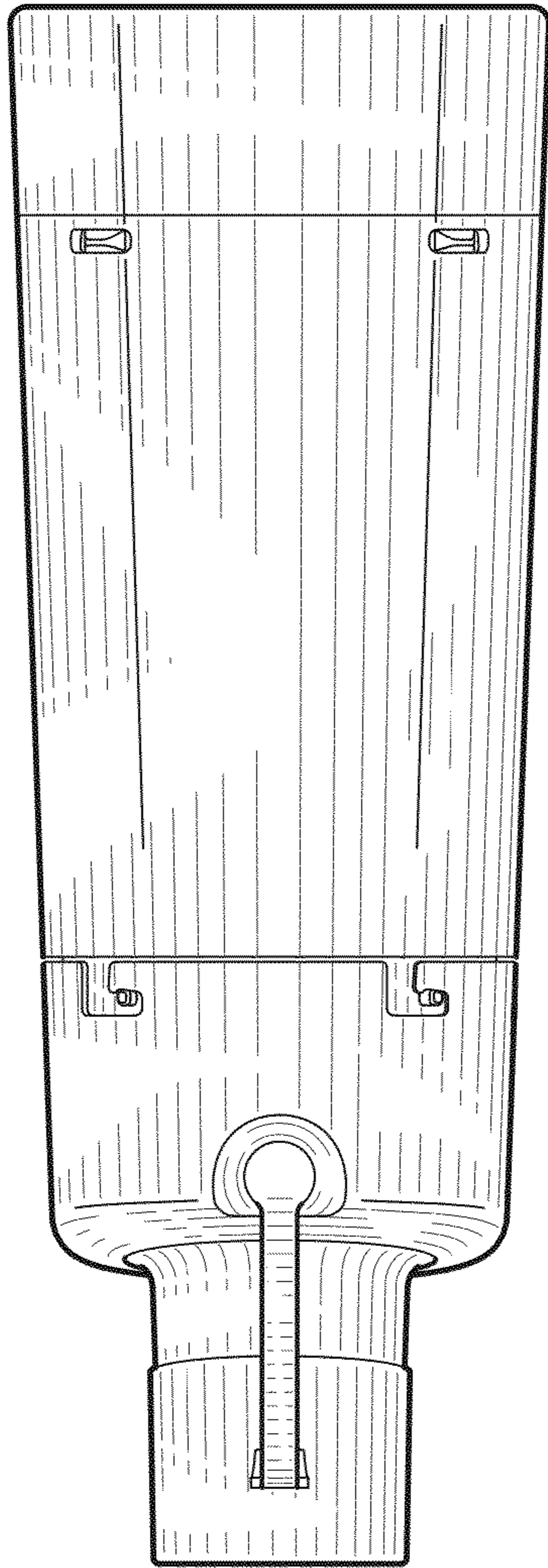

FIG. 6

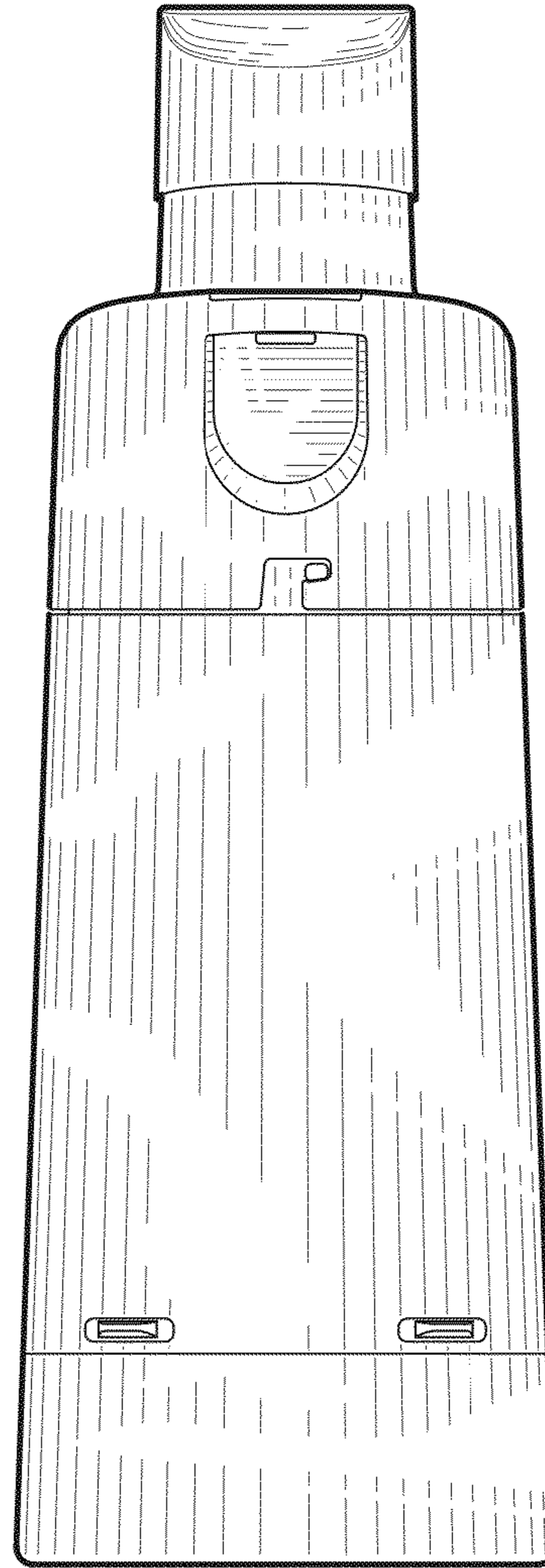

FIG. 7