

US00D692104S

(12) **United States Design Patent**  
**Gessi**

(10) **Patent No.:** **US D692,104 S**

(45) **Date of Patent:** **\*\* Oct. 22, 2013**

- (54) **FAUCET**
- (71) Applicant: **Gessi S.p.A.**, Serravalle Sesia (IT)
- (72) Inventor: **Gian Luca Gessi**, Borgosesia (IT)
- (73) Assignee: **Gessi S.p.A.**, Serravalle Sesia (IT)

(\*\*) Term: **14 Years**

(21) Appl. No.: **29/434,466**

(22) Filed: **Oct. 12, 2012**

(30) **Foreign Application Priority Data**

Apr. 19, 2012 (IT) ..... MI2012O0061  
 Aug. 6, 2012 (IT) ..... MI2012O0117

(51) **LOC (9) Cl.** ..... **23-01**

(52) **U.S. Cl.**  
USPC ..... **D23/238**

(58) **Field of Classification Search**  
USPC ..... D23/238-242, 255, 257, 250, 252;  
4/675-678; 137/801  
See application file for complete search history.

(56) **References Cited**

**U.S. PATENT DOCUMENTS**

- D317,645 S 6/1991 Rosenbaum
- D320,433 S 10/1991 Knapp et al.
- D390,917 S 2/1998 Kergoet
- D448,066 S 9/2001 Zetsche
- D462,421 S \* 9/2002 Hundley ..... D23/252

- D484,220 S 12/2003 Graves et al.
- D484,575 S 12/2003 Graves et al.
- D529,992 S 10/2006 Lammel
- D530,395 S 10/2006 Lammel
- D538,894 S \* 3/2007 Hoernig ..... D23/241
- D541,906 S 5/2007 Qing
- D596,711 S 7/2009 Sieger
- D602,121 S 10/2009 Yabe et al.
- D607,545 S \* 1/2010 Obara ..... D23/255
- D608,419 S 1/2010 Kohler et al.
- D625,393 S \* 10/2010 Sieger ..... D23/242
- D636,066 S \* 4/2011 Schoenherr et al. .... D23/255
- D645,938 S 9/2011 Ando et al.

\* cited by examiner

*Primary Examiner* — Robert Delehanty

(74) *Attorney, Agent, or Firm* — Pearne & Gordon LLP

(57) **CLAIM**

The ornamental design for a faucet, as shown and described.

**DESCRIPTION**

FIG. 1 is a perspective view of a faucet, showing my new design;  
 FIG. 2 is a front elevational view thereof;  
 FIG. 3 is a back elevational view thereof;  
 FIG. 4 is a left side elevational view thereof;  
 FIG. 5 is a right side elevational view thereof;  
 FIG. 6 is a top plan view thereof; and,  
 FIG. 7 is a bottom plan view thereof.  
 The material shown in broken lines is for illustrative purposes only and forms no part of the claimed design.

**1 Claim, 2 Drawing Sheets**

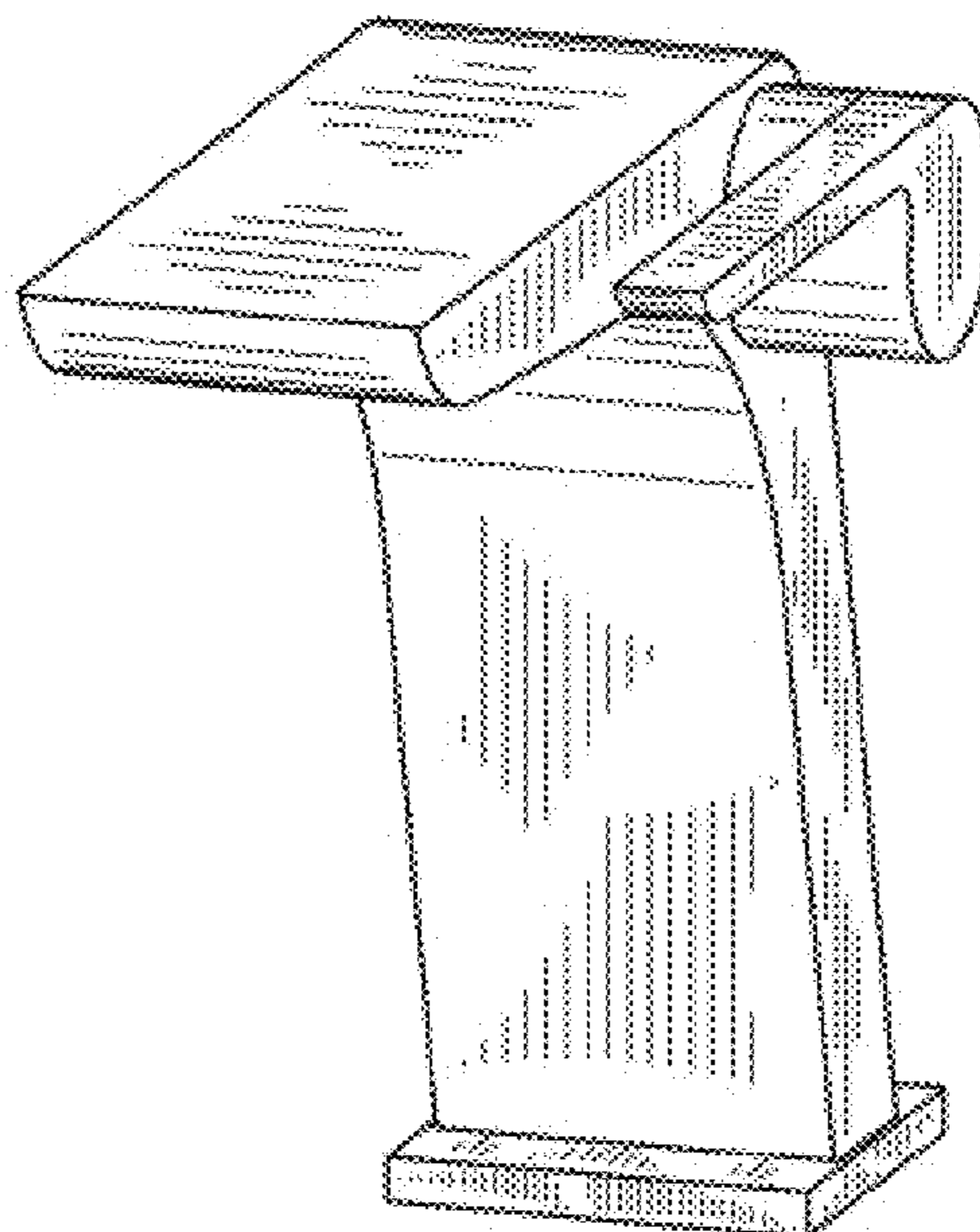

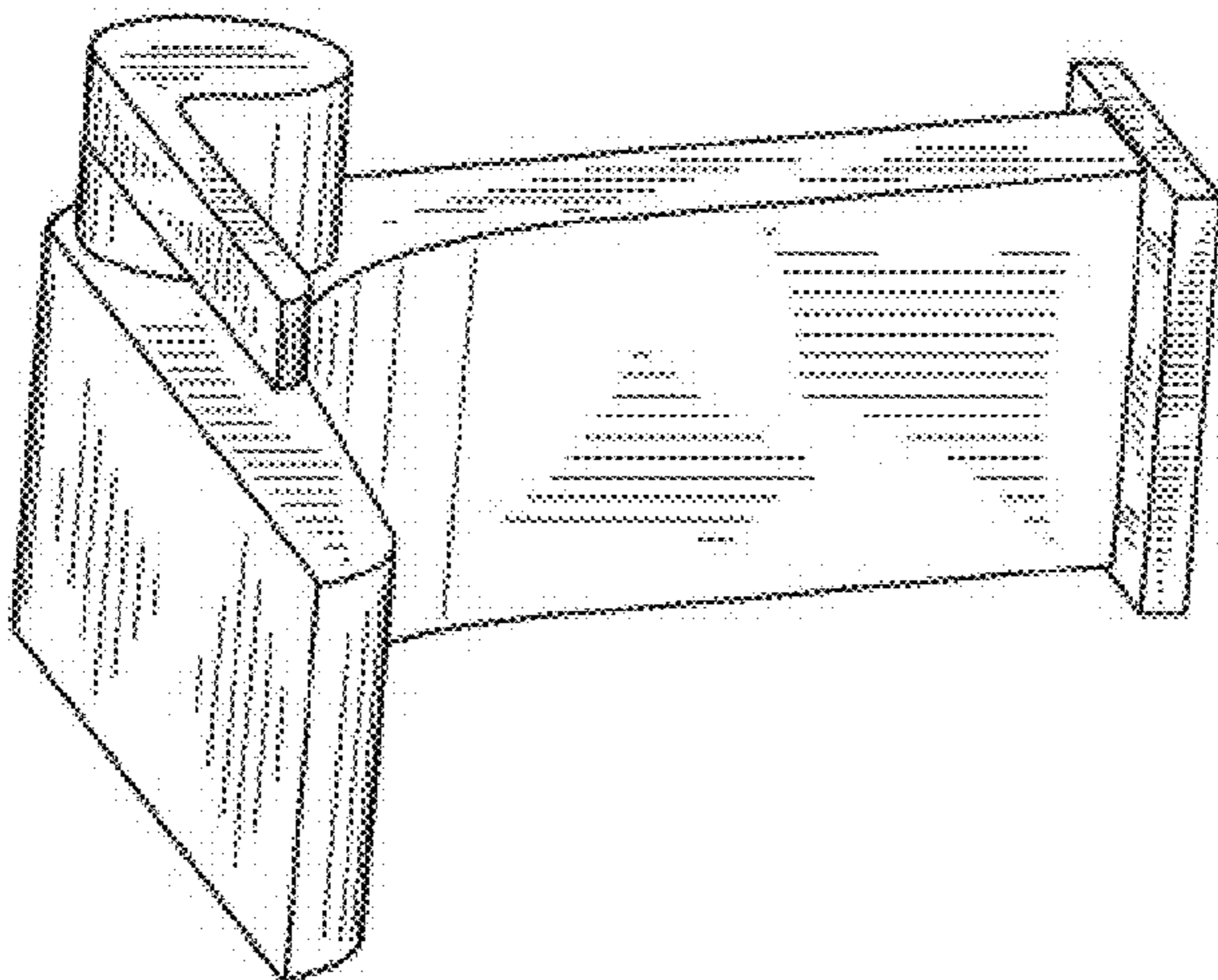

FIG. 1

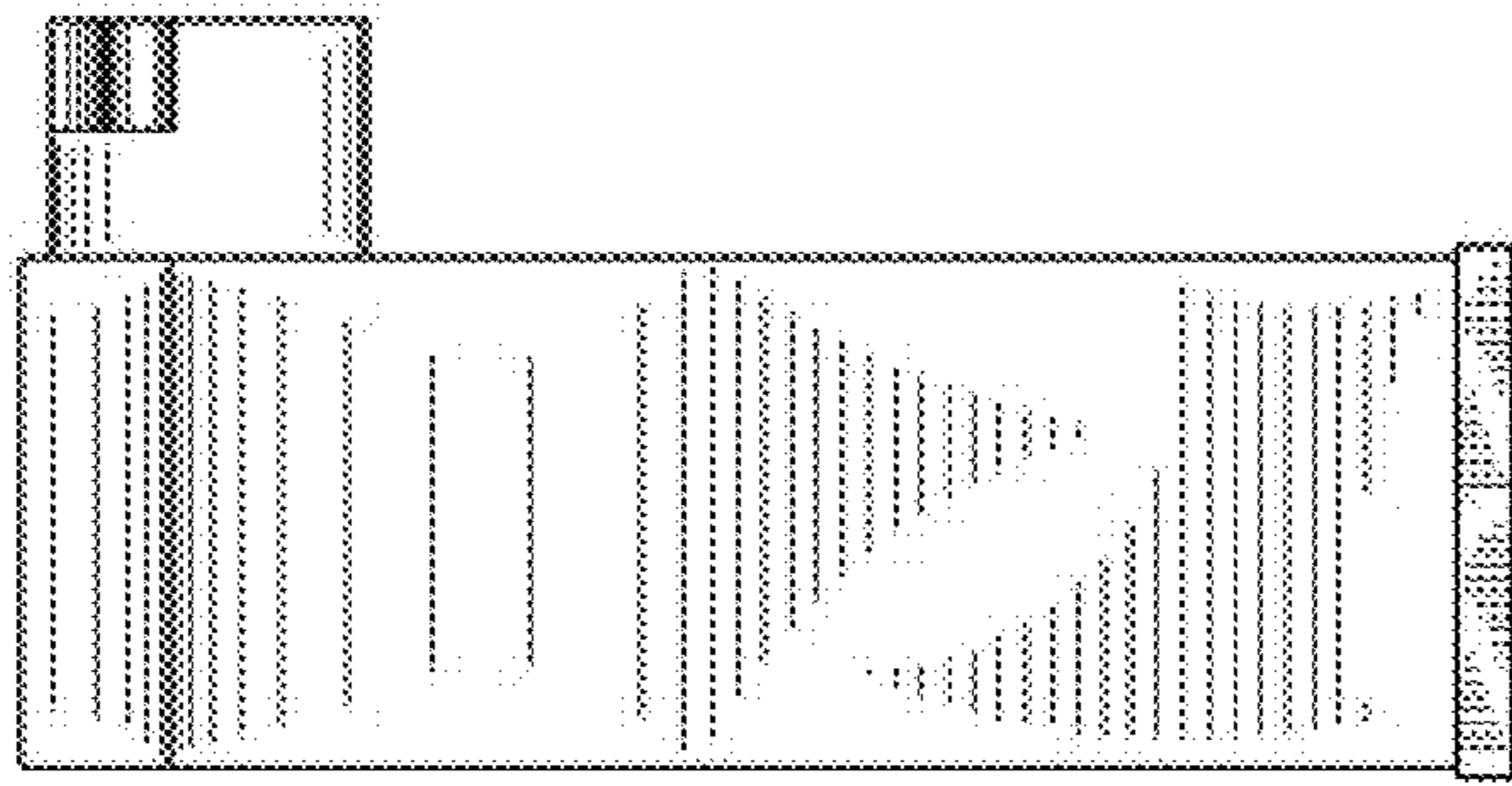

FIG. 2

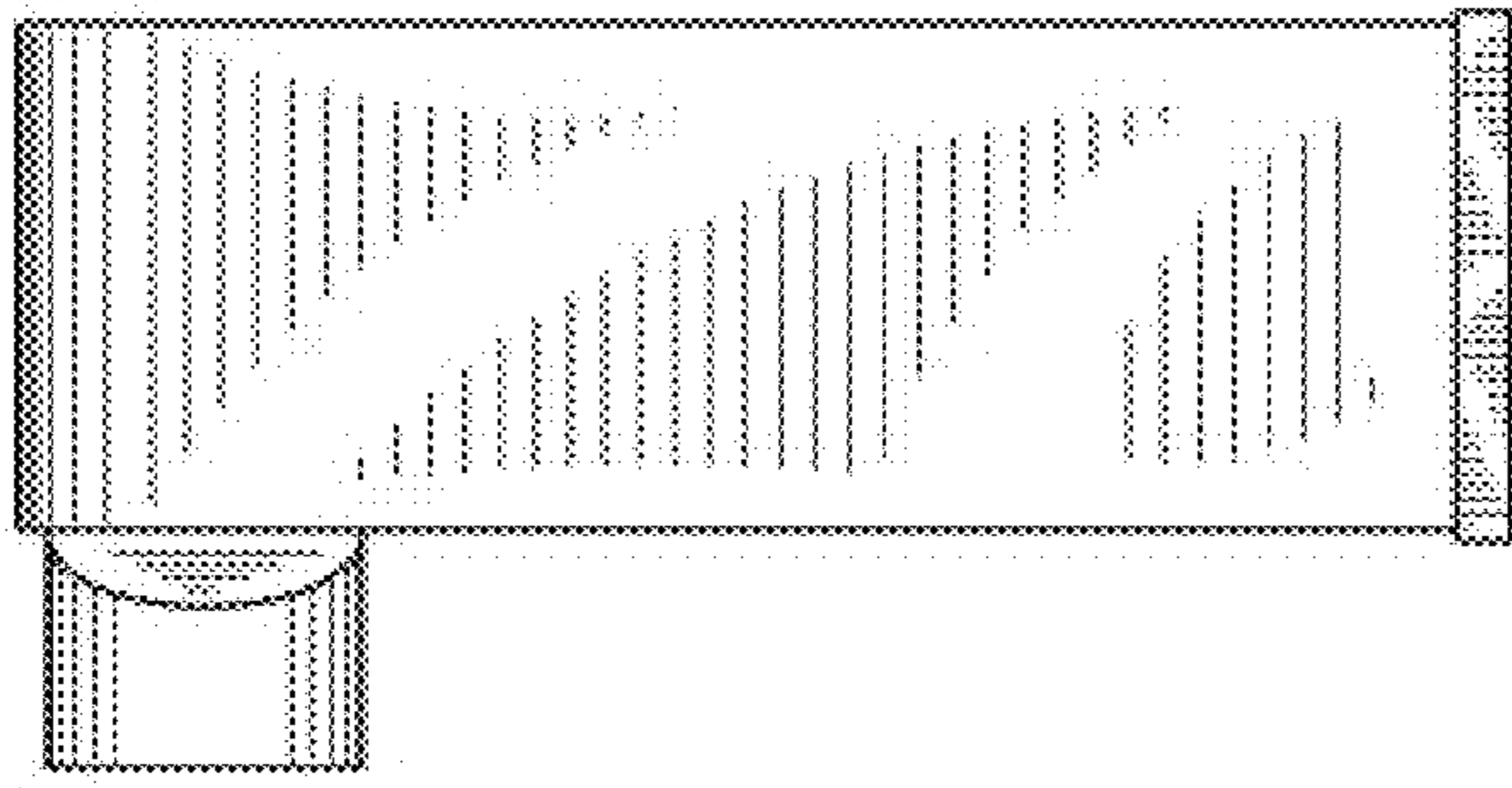

FIG. 3

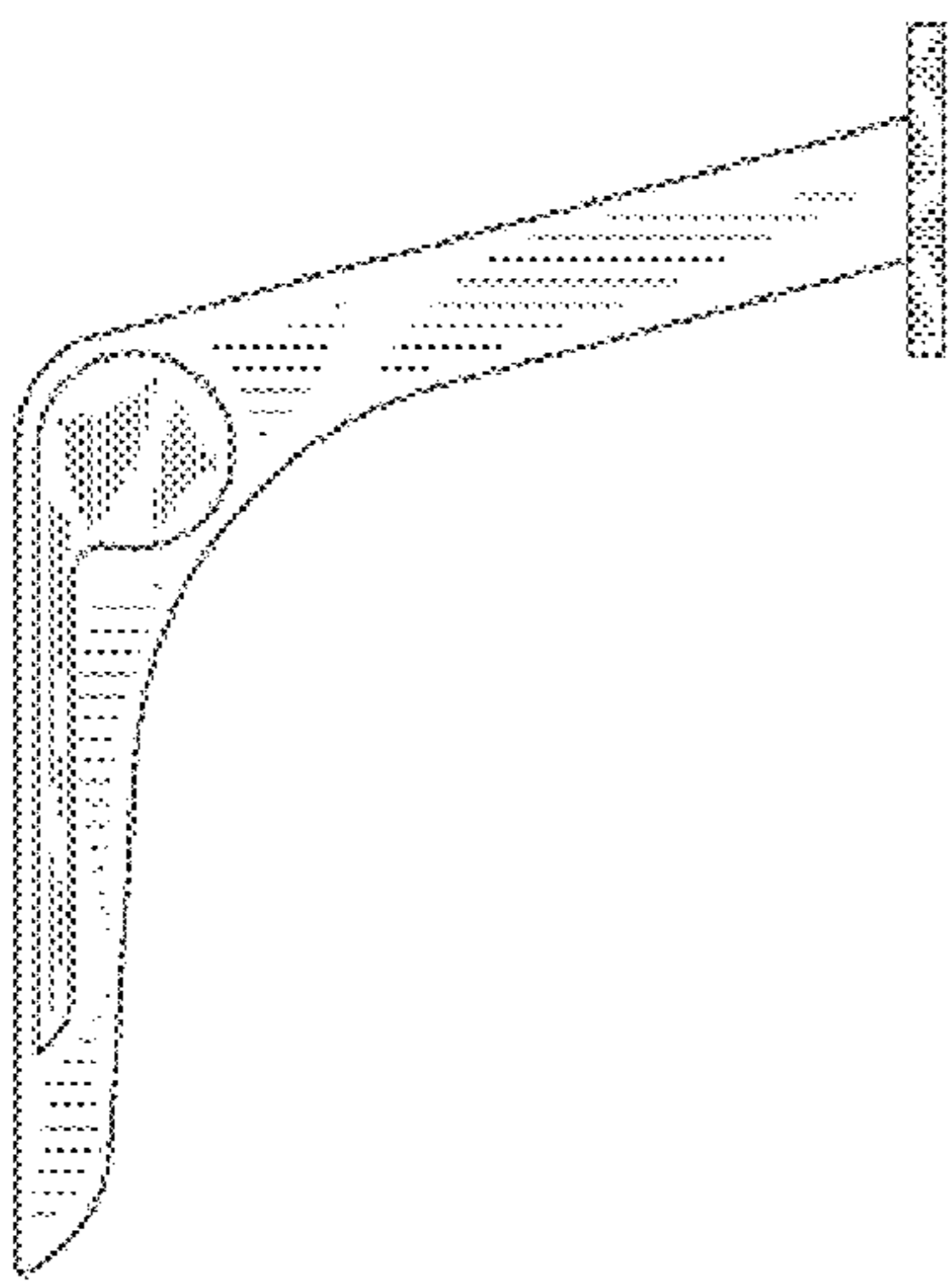

FIG. 4

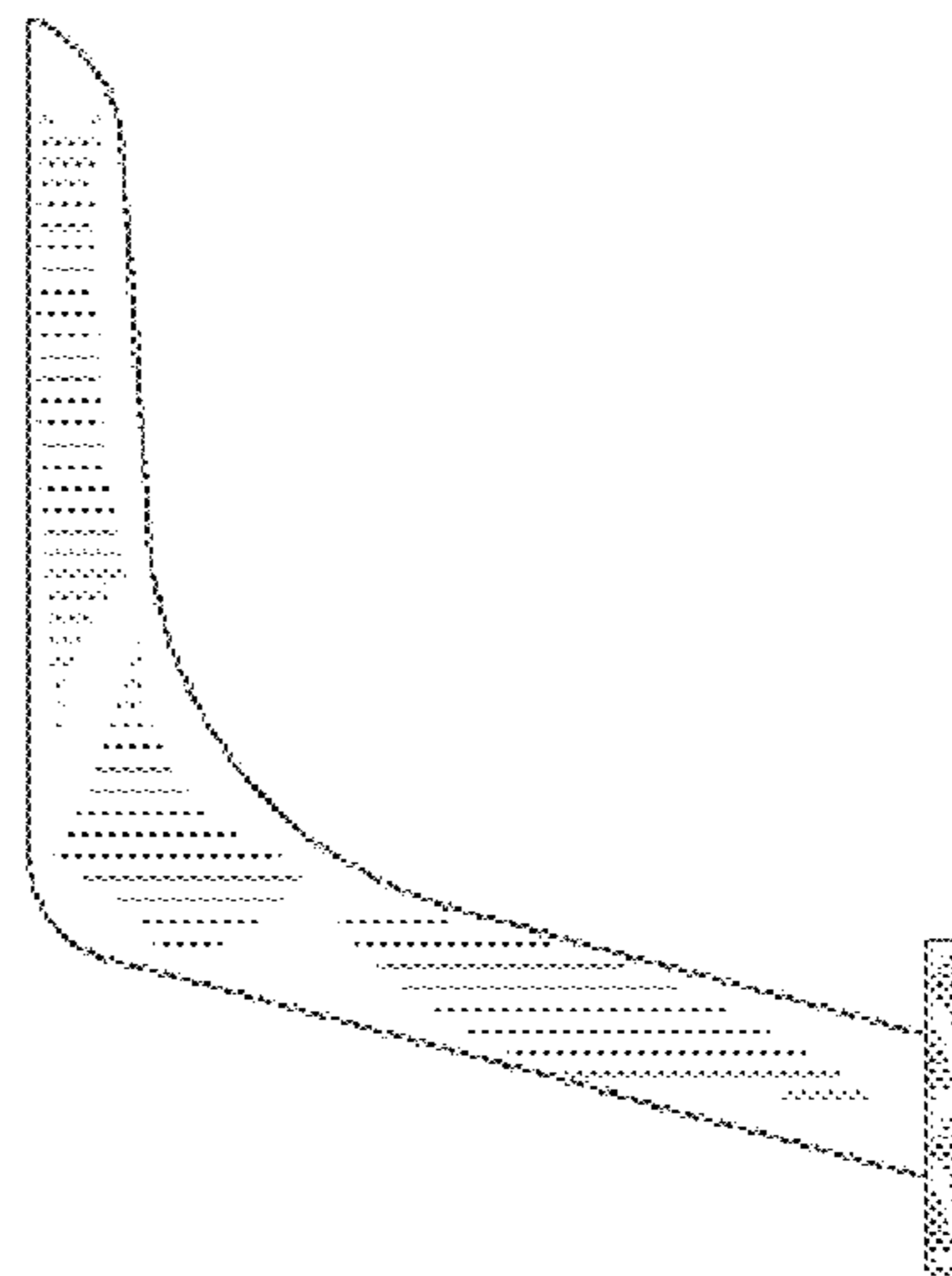

FIG. 5

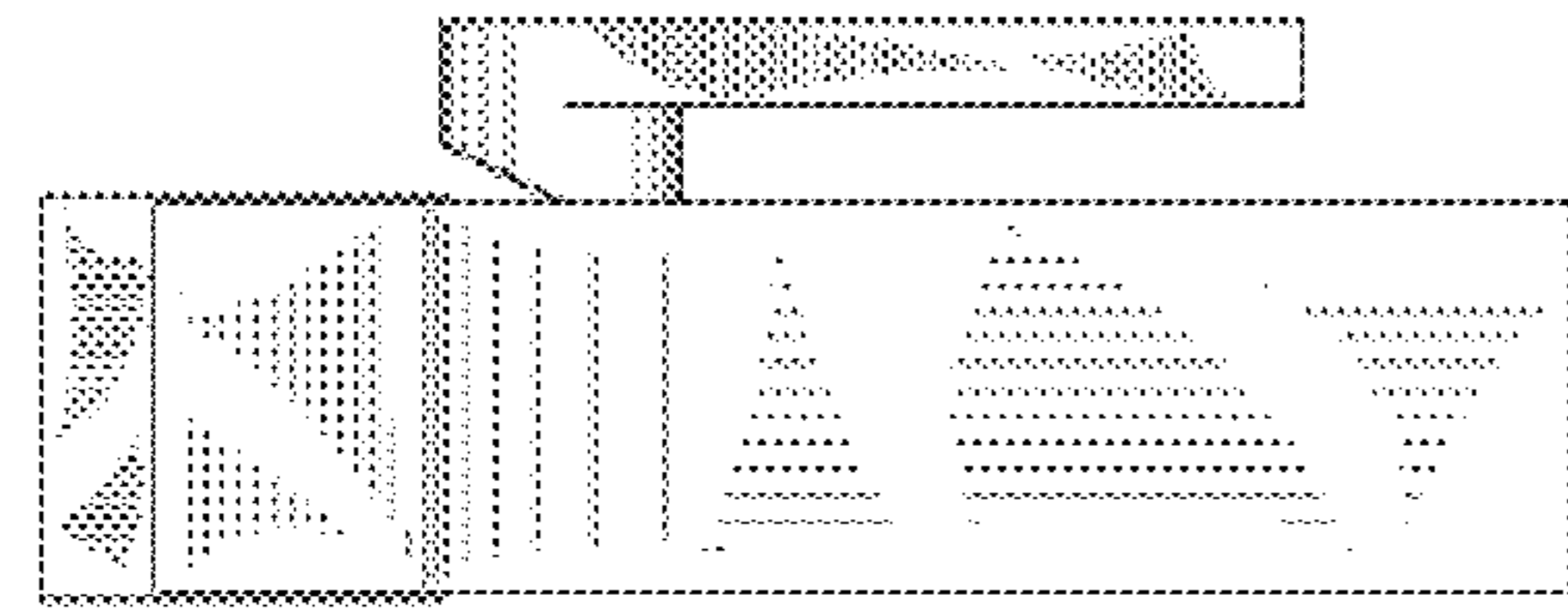

FIG. 6

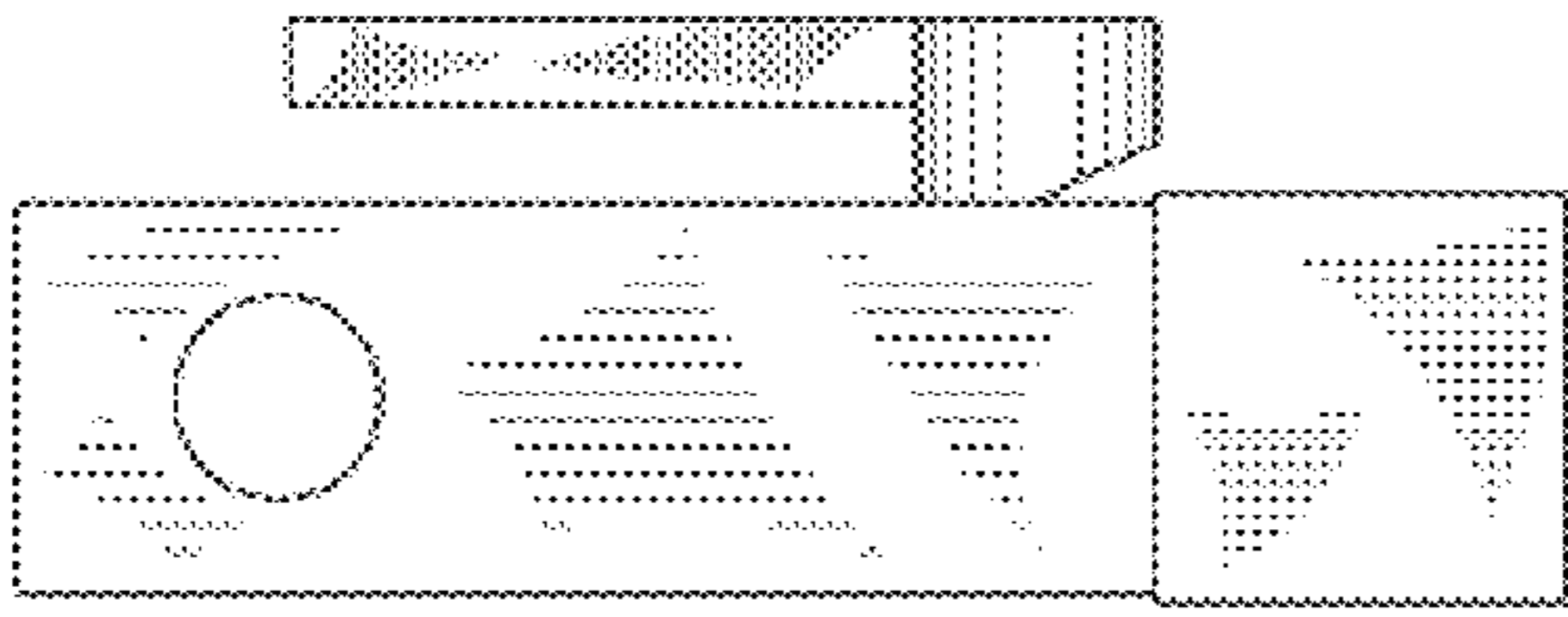

FIG. 7