

US00D692082S

(12) **United States Design Patent**
Lee

(10) **Patent No.:** **US D692,082 S**

(45) **Date of Patent:** **** Oct. 22, 2013**

(54) **LIFE JACKET**

(71) Applicant: **David Thornton Lee**, Memphis, TN
(US)

(72) Inventor: **David Thornton Lee**, Memphis, TN
(US)

(**) Term: **14 Years**

(21) Appl. No.: **29/444,216**

(22) Filed: **Jan. 28, 2013**

(51) **LOC (9) Cl.** **29-02**

(52) **U.S. Cl.**
USPC **D21/805**

(58) **Field of Classification Search**
USPC D21/804, 805; D29/100, 101.1, 101, 4;
2/456, 458, 467, 463; 441/88, 89, 106,
441/108, 111, 114–117
See application file for complete search history.

(56) **References Cited**

U.S. PATENT DOCUMENTS

D333,903 S * 3/1993 Meredith D2/731
D375,581 S * 11/1996 Dyer D29/101.1
D379,396 S * 5/1997 Rongo et al. D21/805

5,785,568 A * 7/1998 Lake 441/127
D424,153 S * 5/2000 Shaffer D21/804
D501,907 S * 2/2005 Peterson D21/805
D511,238 S * 11/2005 Herman et al. D2/733
D554,225 S * 10/2007 Peterson D21/805
D676,514 S * 2/2013 Dudley et al. D21/805

* cited by examiner

Primary Examiner — Zenia Bennett
(74) *Attorney, Agent, or Firm* — Butler, Snow, O’Mara,
Stevens & Cannada PLLC

(57) **CLAIM**

I claim the ornamental design for a life jacket, as shown and described.

DESCRIPTION

FIG. 1 is a perspective view of the life jacket from above.
FIG. 2 is the front elevational view thereof.
FIG. 3 is the right side elevational view thereof.
FIG. 4 is the rear elevational view.
FIG. 5 is the left side elevational view.
FIG. 6 is a top plan view; and,
FIG. 7 is a bottom plan view.
The broken lines in the drawing are for illustrative purposes only and form no part of the claimed design.

1 Claim, 7 Drawing Sheets

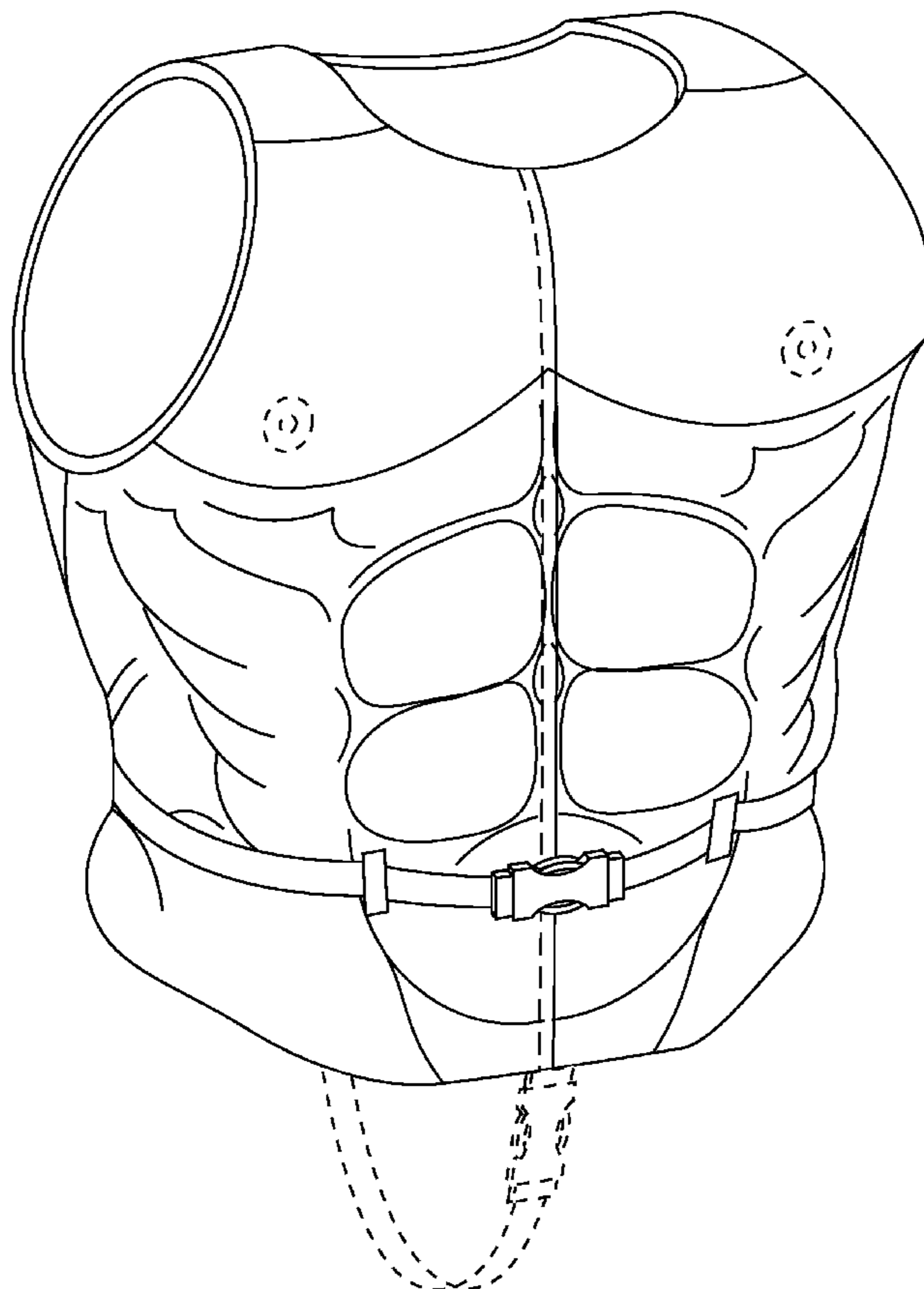

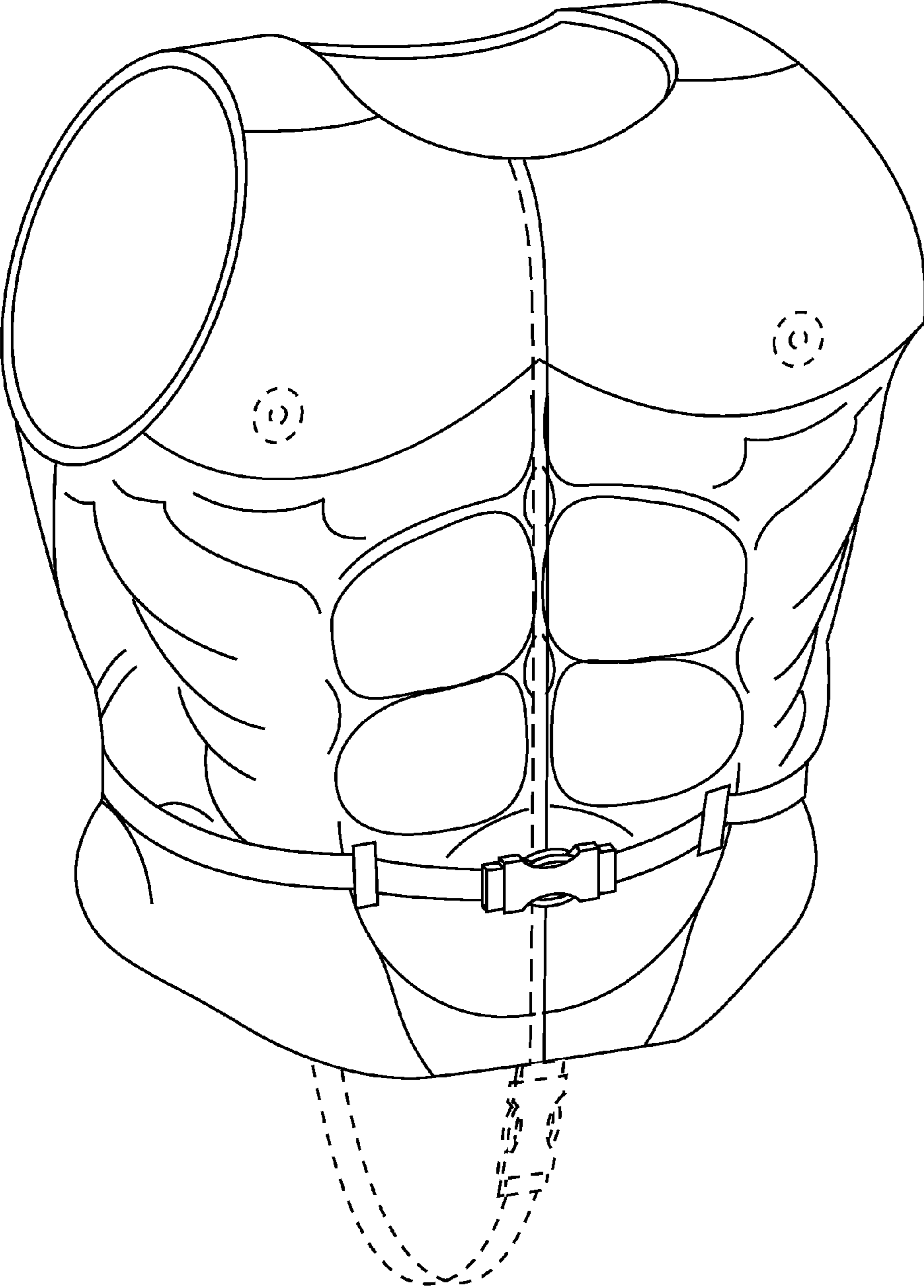

FIG. 1

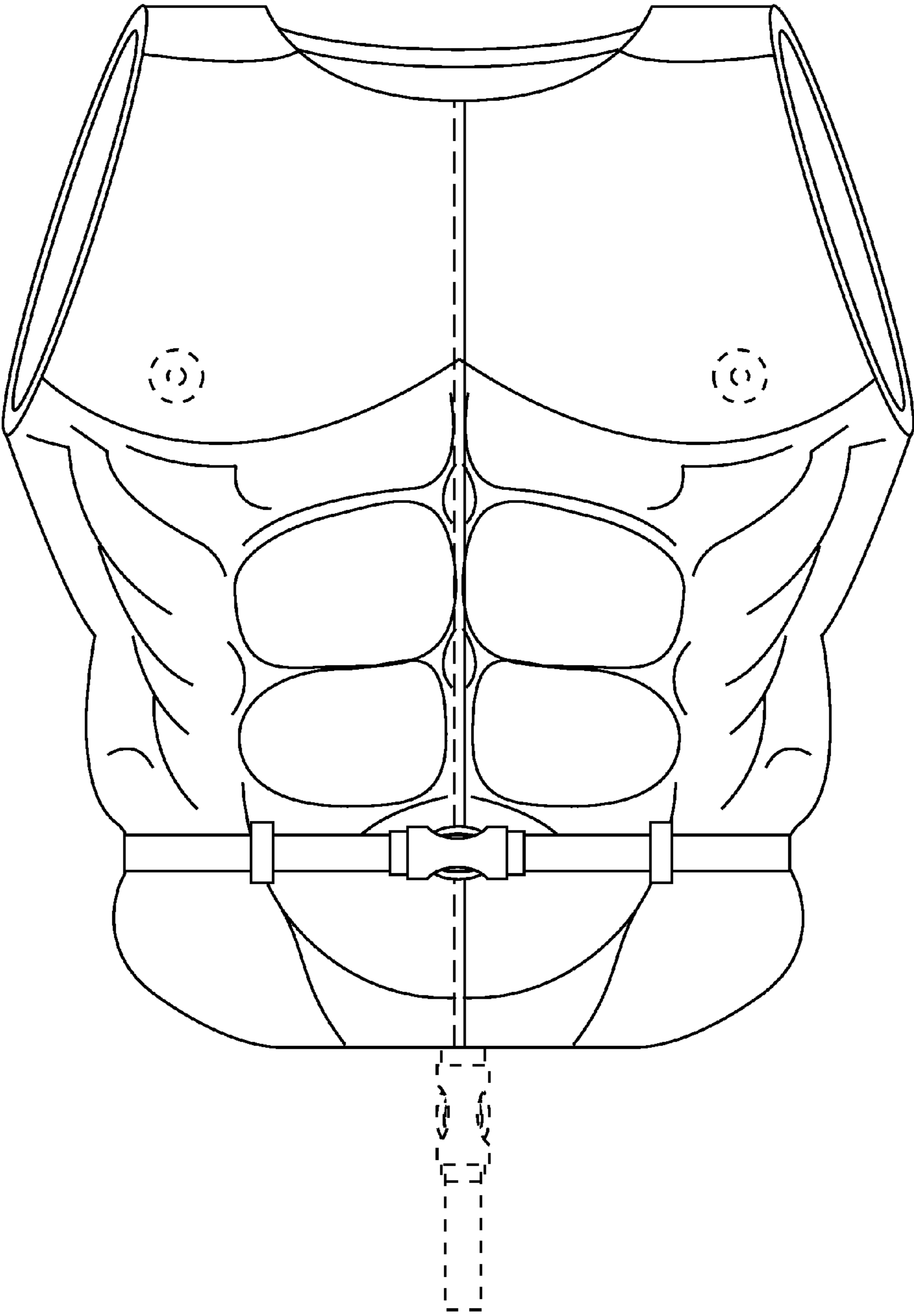

FIG. 2

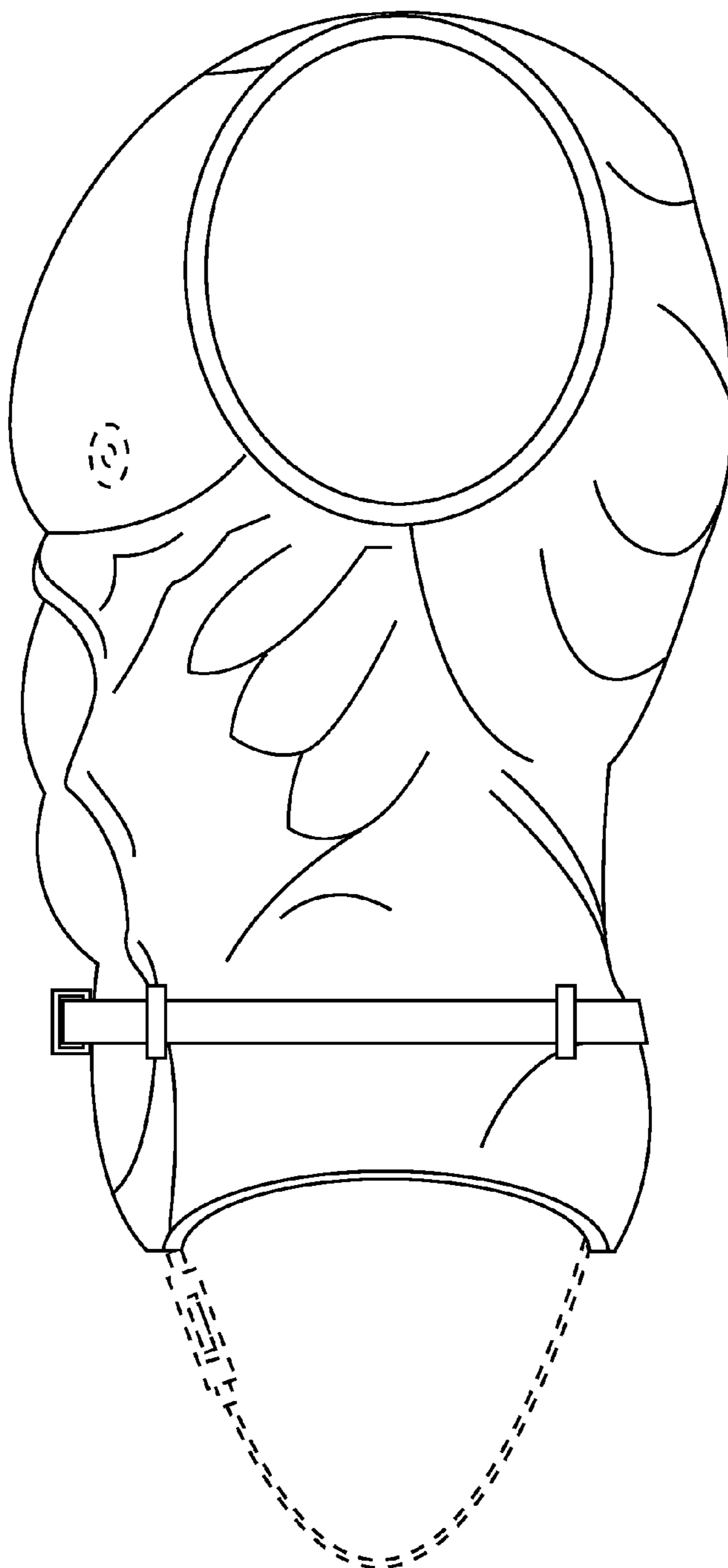

FIG. 3

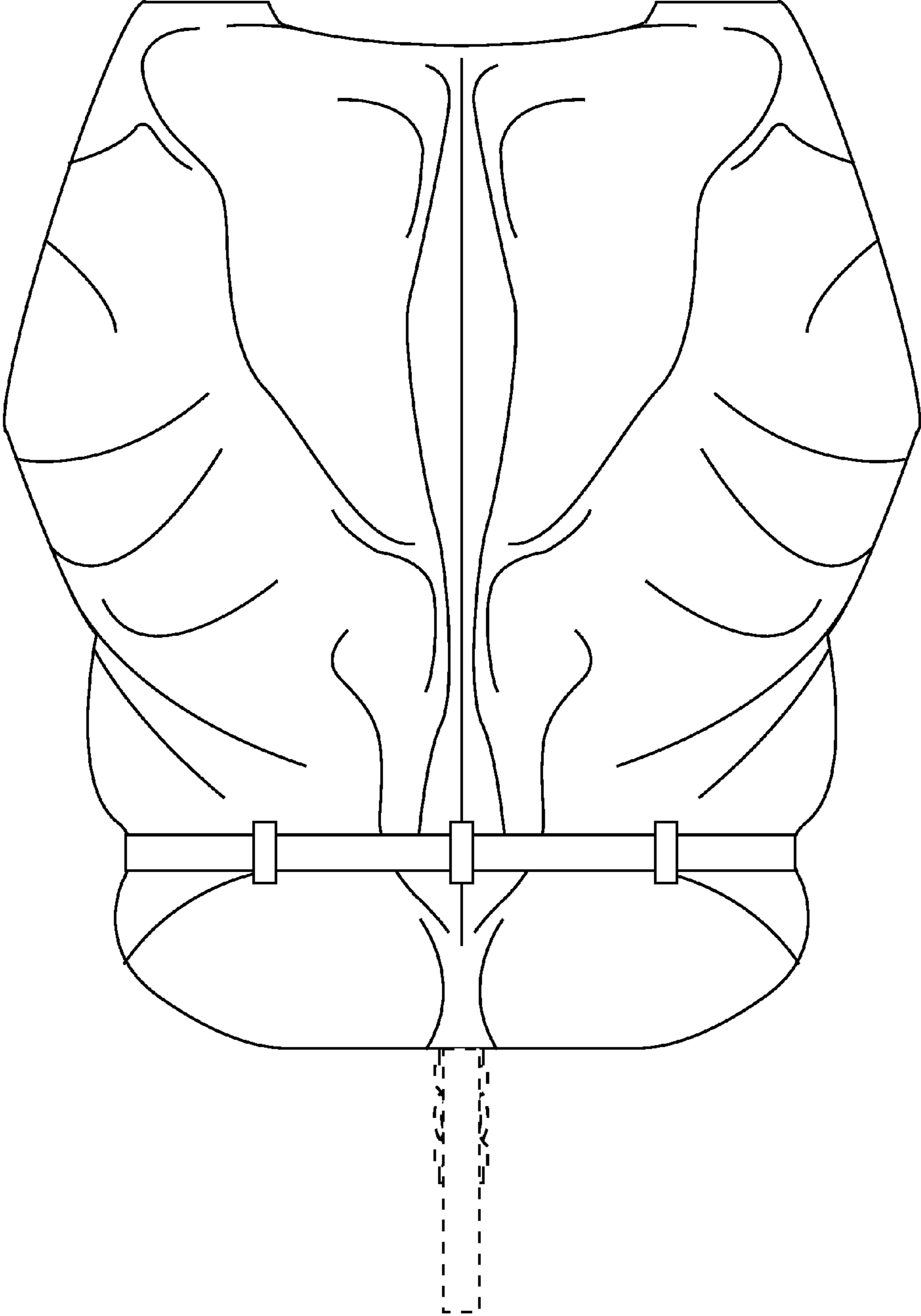

FIG. 4

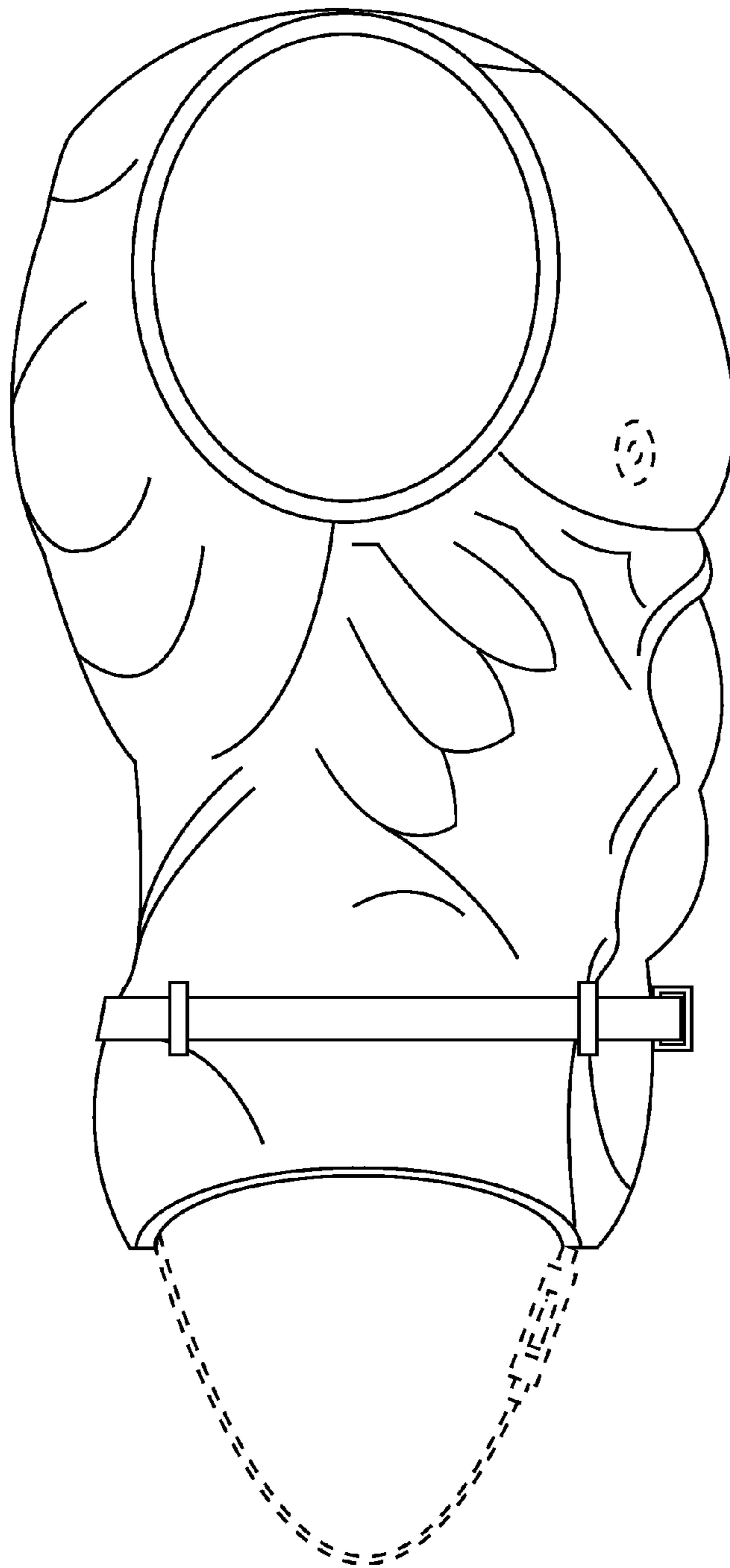

FIG. 5

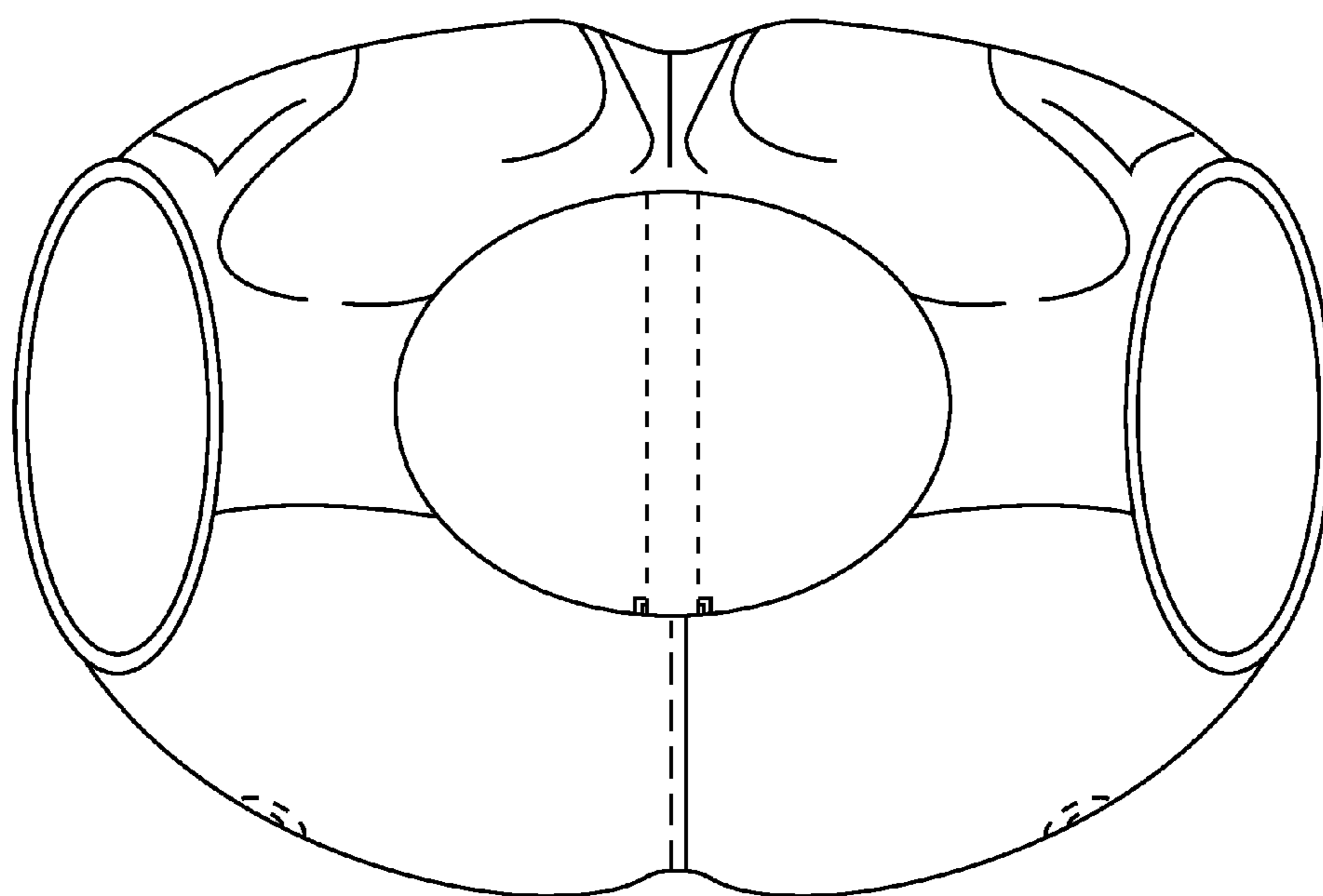

FIG. 6

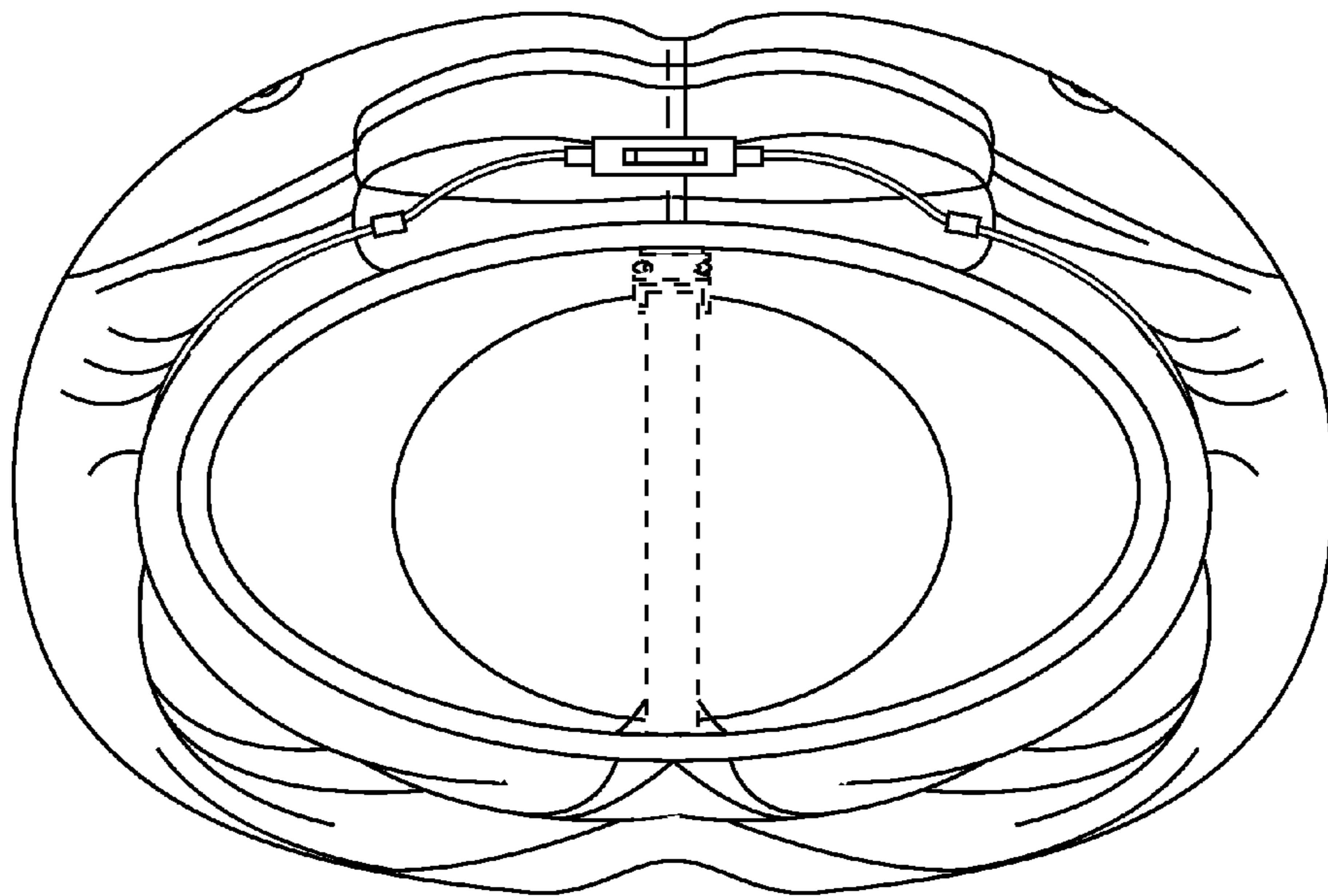

FIG. 7