

US00D692046S

(12) **United States Design Patent**
Fuchs

(10) **Patent No.:** **US D692,046 S**
(45) **Date of Patent:** **** Oct. 22, 2013**

- (54) **EYEGLASSES**
- (75) Inventor: **Gerhard Fuchs**, Kauns (AT)
- (73) Assignee: **Silhouette International Schmied AG**,
Linz (AT)
- (**) Term: **14 Years**
- (21) Appl. No.: **29/430,852**
- (22) Filed: **Aug. 30, 2012**
- (51) **LOC (9) Cl.** **16-06**
- (52) **U.S. Cl.**
USPC **D16/315; D16/335; D16/321**
- (58) **Field of Classification Search**
USPC D16/101, 300–342, 900; D29/109–110;
D24/110.2; 351/41, 44, 51–52, 62,
351/158, 92, 103–123, 140, 153, 45–46;
2/426–432, 447–449, 441, 434–437,
2/13, 15; D21/483, 659–661; D14/372
See application file for complete search history.

D413,138 S *	8/1999	Flanagan	D16/320
5,956,116 A	9/1999	Ishiyama		
D426,566 S	6/2000	Hirschman et al.		
D429,752 S	8/2000	Polland		
D430,191 S	8/2000	Hirschman et al.		
D434,790 S	12/2000	Lepeu et al.		
6,238,048 B1 *	5/2001	Fukuoka	351/114
6,290,355 B1	9/2001	Chen		
D455,451 S	4/2002	Onodera		
D463,814 S	10/2002	Jamin		
D465,509 S	11/2002	Jamin		
D467,960 S	12/2002	Jamin		

(Continued)

OTHER PUBLICATIONS

Design U.S. Appl. No. 29/394,498, filed Jun. 17, 2011.

(Continued)

Primary Examiner — Raphael Barkai
(74) *Attorney, Agent, or Firm* — Alston & Bird LLP

(57) **CLAIM**
I claim the ornamental design for eyeglasses, as shown and described.

(56) **References Cited**
U.S. PATENT DOCUMENTS

D13,053 S	7/1882	Meyer et al.
D719,790	2/1903	Gregory
2,269,037 A	1/1942	Oker
2,669,903 A	2/1954	Tardy
D198,643 S	7/1964	Wilson
4,187,007 A	2/1980	Lauffer
D285,092 S	8/1986	Baum
D305,900 S	2/1990	Samuel
5,471,257 A	11/1995	Houmand
D374,883 S	10/1996	Luzlbauer
D385,290 S	10/1997	Totsuka
D392,661 S	3/1998	Porsche et al.
D394,447 S	5/1998	Khantzis
D405,105 S	2/1999	Gerani
D406,859 S	3/1999	Brune
5,880,807 A	3/1999	Devercelli

DESCRIPTION

FIG. 1 is a perspective view of eyeglasses showing my new design;
FIG. 2 is an enlarged perspective view of a portion thereof;
FIG. 3 is a top plan view thereof;
FIG. 4 is a bottom plan view thereof;
FIG. 5 is a front elevation view thereof;
FIG. 6 is a rear elevation view thereof;
FIG. 7 is a left side elevation view thereof; and,
FIG. 8 is side elevation cross-section view thereof taken along line 8-8 in FIG. 3.
The broken lines are directed to unclaimed features. The broken lines form no part of the claimed design.

1 Claim, 6 Drawing Sheets

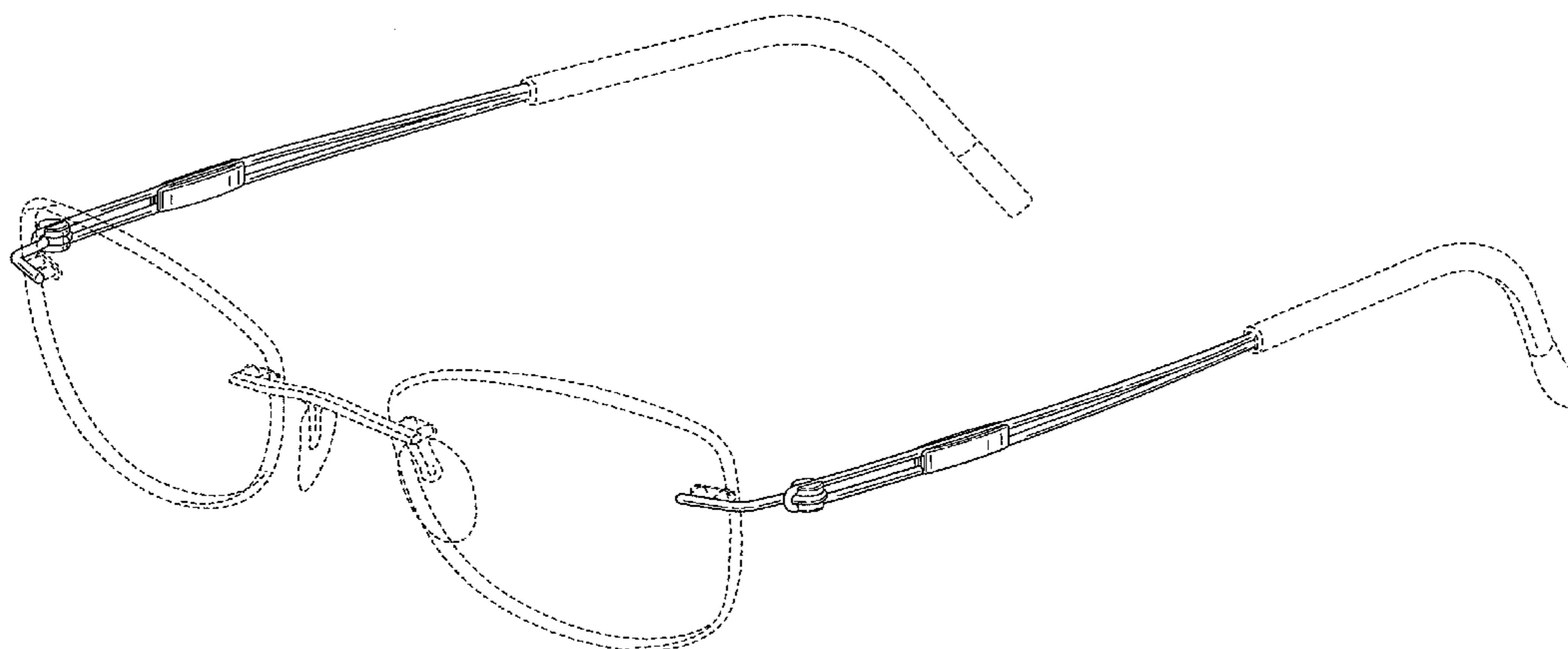

(56)

References Cited

U.S. PATENT DOCUMENTS

D472,254 S 3/2003 Mitchell, Jr.
 D473,581 S 4/2003 Hirschman
 D476,676 S 7/2003 Nielsen
 D480,413 S 10/2003 Nielsen
 D481,059 S 10/2003 Egbert et al.
 6,655,800 B2 12/2003 Takeda et al.
 D488,829 S 4/2004 Hester
 D489,393 S 5/2004 Hester
 6,729,725 B1 5/2004 Cheng
 D491,214 S 6/2004 Nielsen
 D495,357 S 8/2004 Nielsen
 D508,514 S 8/2005 Hester
 D531,656 S 11/2006 Della Valle
 D533,579 S 12/2006 Raile
 D536,023 S 1/2007 Park
 D536,723 S 2/2007 Mouclier
 D537,862 S 3/2007 Mouclier
 D540,845 S 4/2007 Nakanishi
 D542,329 S 5/2007 Hester
 D543,230 S 5/2007 Nakanishi
 D553,175 S 10/2007 Lamy
 D554,176 S 10/2007 Elmore
 D556,819 S 12/2007 Fuchs
 D567,838 S 4/2008 Fuchs
 D567,839 S 4/2008 Fuchs

D573,170 S * 7/2008 Fuchs D16/316
 D577,377 S 9/2008 Fuchs
 D581,445 S 11/2008 Nakanishi
 D581,448 S 11/2008 Fuchs
 D582,958 S 12/2008 Fuchs
 D582,963 S 12/2008 Fuchs
 D582,964 S 12/2008 Fuchs
 D582,965 S 12/2008 Fuchs
 7,497,571 B2 3/2009 Rossin
 D590,005 S 4/2009 Fuchs
 D591,788 S * 5/2009 Fuchs D16/315
 D593,145 S 5/2009 Fuchs
 D593,593 S * 6/2009 Fuchs D16/315
 D597,123 S 7/2009 Strecker
 D601,181 S 9/2009 Fuchs
 D602,975 S * 10/2009 Fuchs D16/315
 7,794,080 B2 9/2010 Zelazowski
 D633,940 S 3/2011 Preuer-Lackner
 D635,180 S 3/2011 Della Valle et al.
 D650,002 S * 12/2011 Zoonens D16/315
 D661,723 S 6/2012 Fuchs
 2005/0286012 A1 12/2005 Ogren et al.

OTHER PUBLICATIONS

Sunglass Hut catalog, p. 21, 2002.
 America's premier paver catalog, CAD design: Patterns.

* cited by examiner

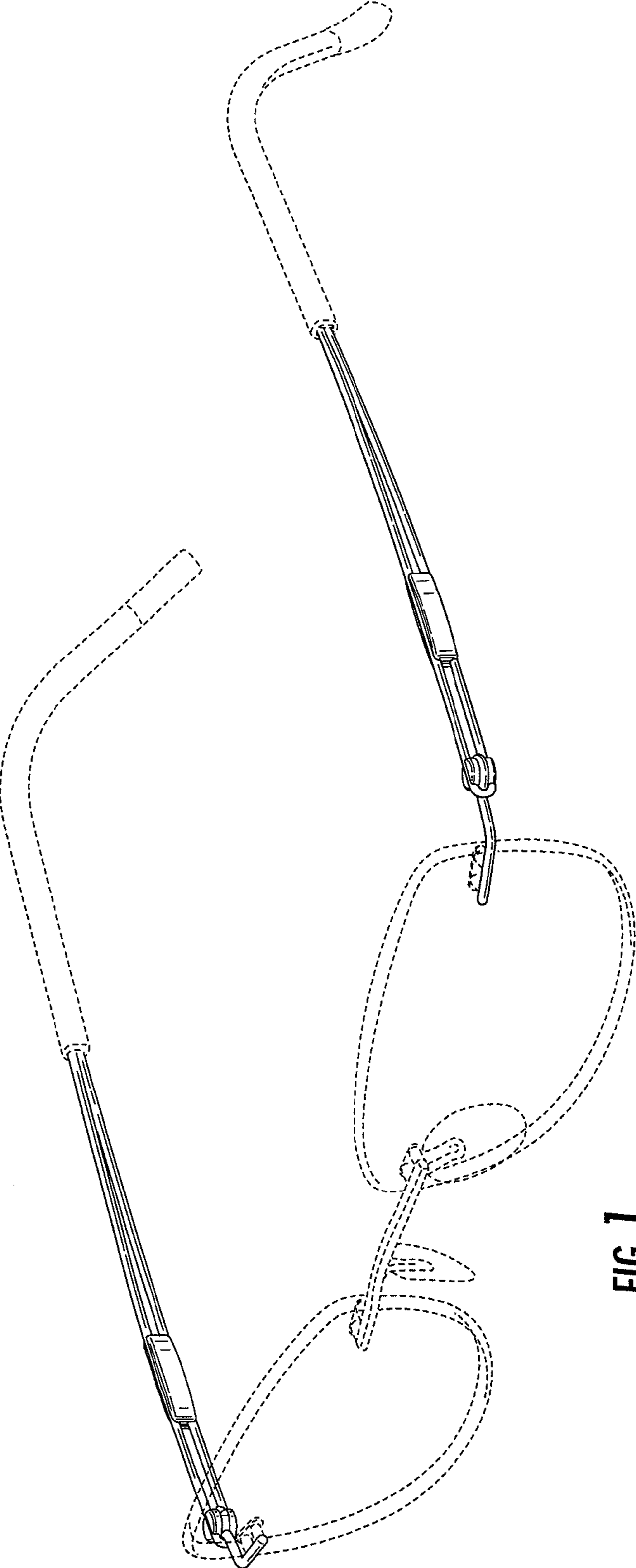

FIG. 1

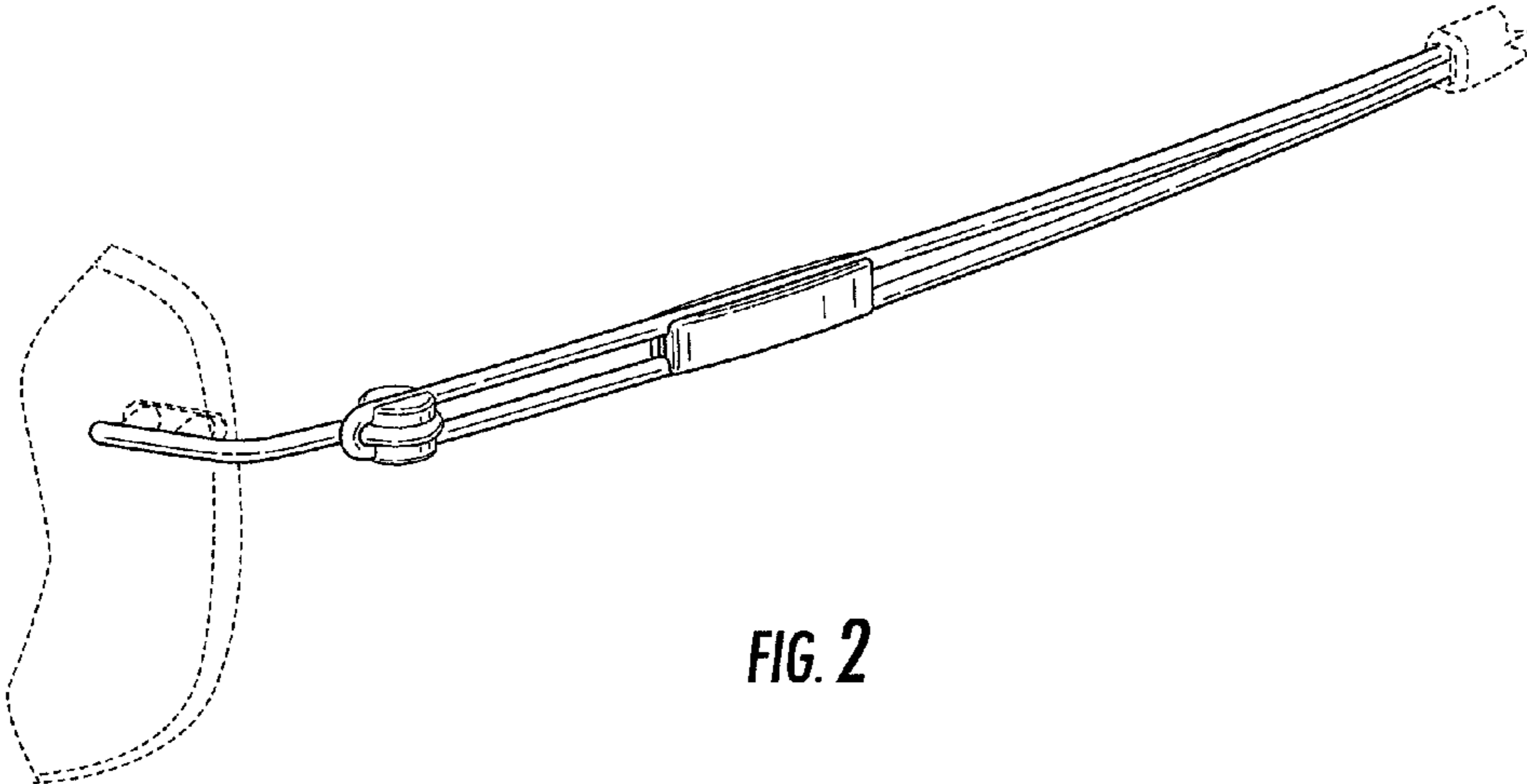

FIG. 2



FIG. 3



FIG. 4

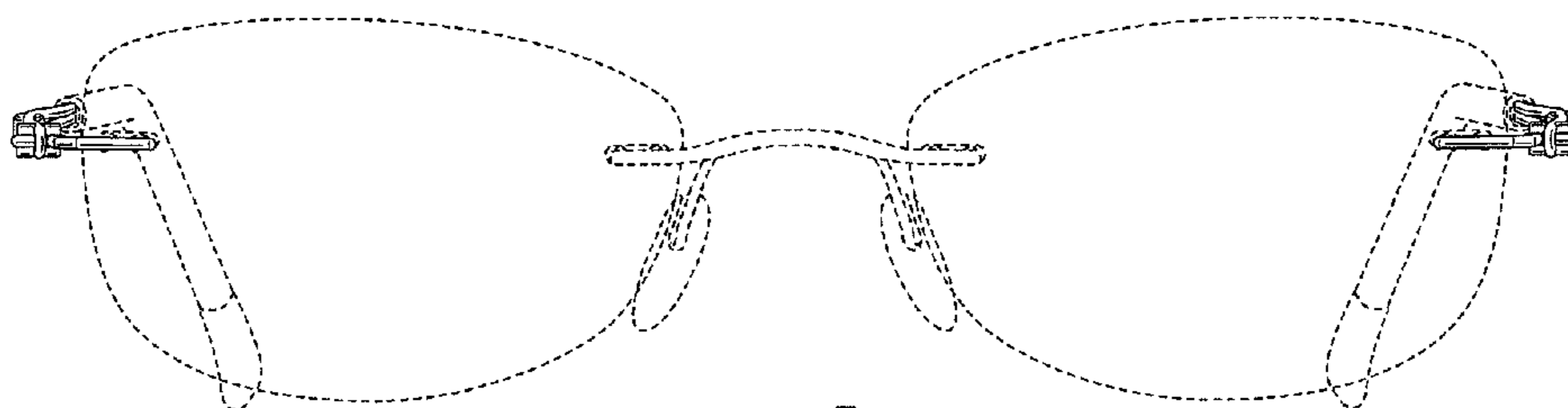

FIG. 5

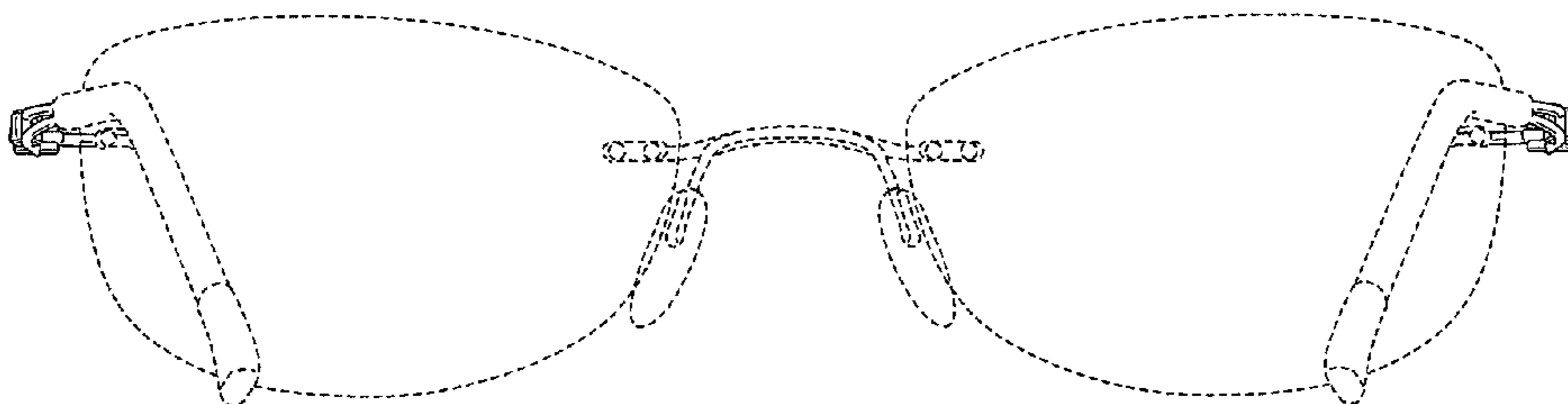

FIG. 6

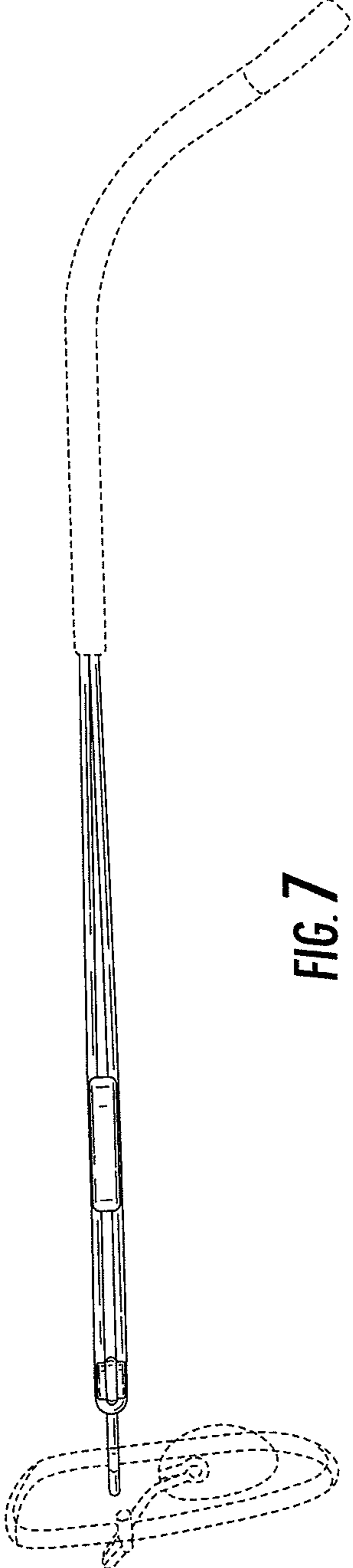

FIG. 7

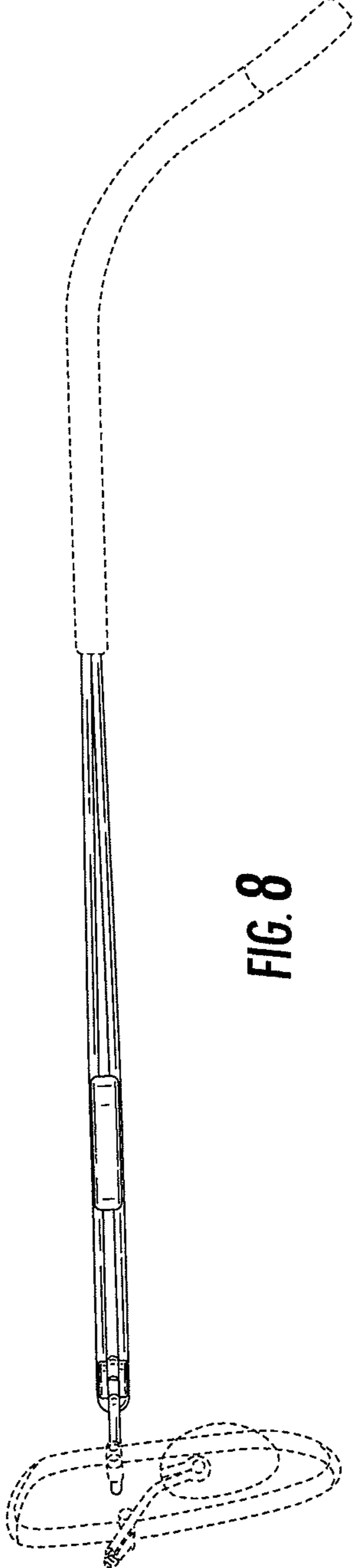

FIG. 8

UNITED STATES PATENT AND TRADEMARK OFFICE
CERTIFICATE OF CORRECTION

PATENT NO. : D692,046 S
APPLICATION NO. : 29/430852
DATED : October 22, 2013
INVENTOR(S) : Fuchs

Page 1 of 1

It is certified that error appears in the above-identified patent and that said Letters Patent is hereby corrected as shown below:

Title page.

Insert the following:

item --(30) Foreign Application Priority Data
Jul. 6, 2012 (EM)..... 002069260--.

Signed and Sealed this
Tenth Day of December, 2013

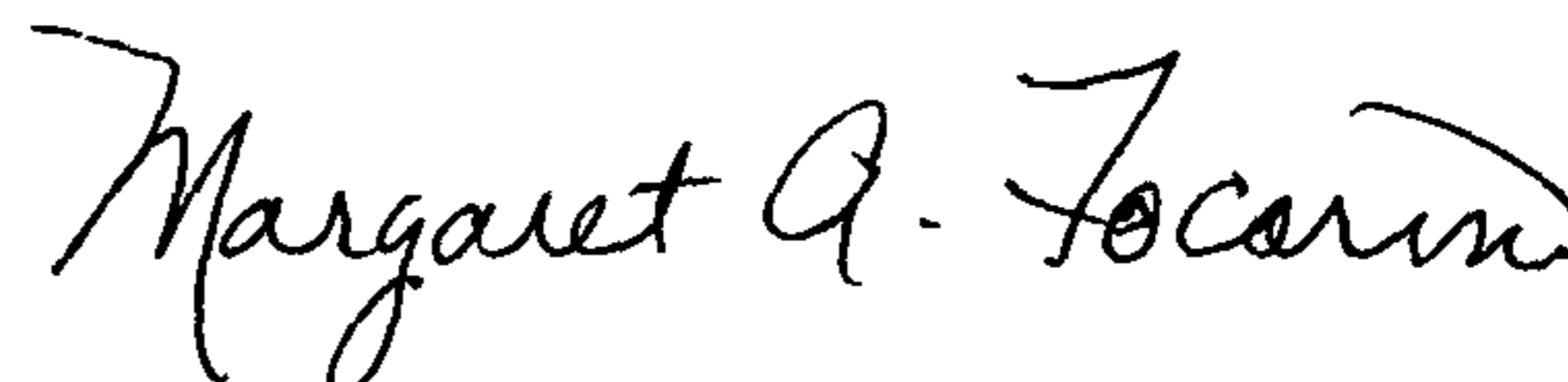

Margaret A. Focarino
Commissioner for Patents of the United States Patent and Trademark Office