

US00D692032S

(12) **United States Design Patent**
LaFond et al.

(10) **Patent No.:** **US D692,032 S**
(45) **Date of Patent:** **** Oct. 22, 2013**

(54) **ICE MACHINE**

(75) Inventors: **Marty James LaFond**, Algoma, WI (US); **Mark Paul Giebel**, Manitowoc, WI (US); **Steve David Herning**, Marinette, WI (US); **John Phillip Myers**, Manitowoc, WI (US); **Paula Forseth Dick**, Sheboygan, WI (US); **Curt Richard Cayemberg**, Manitowoc, WI (US); **Dean Marvin Petersen**, Manitowoc, WI (US)

(73) Assignee: **Manitowoc Foodservice Companies, LLC**, Manitowoc, WI (US)

(**) Term: **14 Years**

(21) Appl. No.: **29/426,869**

(22) Filed: **Jul. 11, 2012**

(51) **LOC (9) Cl.** **15-07**

(52) **U.S. Cl.**
USPC **D15/80**

(58) **Field of Classification Search**
USPC D15/79-81, 83; 62/73, 80, 138, 62/246-254, 340, 457.1
See application file for complete search history.

(56) **References Cited**

U.S. PATENT DOCUMENTS

2,962,869 A * 12/1960 Bartels 62/138
2,983,109 A * 5/1961 Leeson 62/73

D200,133 S * 1/1965 Young D15/80
3,220,207 A * 11/1965 Cordes 62/138
D407,421 S * 3/1999 Strandell et al. D15/80
D431,576 S * 10/2000 Okuda D15/80
D455,158 S * 4/2002 Gray et al. D15/80
D557,716 S * 12/2007 Okuda D15/80
D597,107 S * 7/2009 Ohtake D15/80

OTHER PUBLICATIONS

India Patent Office First Examination Report No. 247468/D/NF/SKC dated Nov. 7, 2012 from corresponding India Design Application No. 247468, pp. 2.

* cited by examiner

Primary Examiner — Mitchell Siegel

(74) *Attorney, Agent, or Firm* — Ohlandt, Greeley, Ruggiero & Perle, L.L.P.

(57) **CLAIM**

The ornamental design for an ice machine, as shown and described.

DESCRIPTION

FIG. 1 is a top side perspective view of the ice machine according to the present design;
FIG. 2 is a front view of the ice machine of FIG. 1;
FIG. 3 is a rear view of the ice machine of FIG. 1;
FIG. 4 is a first side view of the ice machine of FIG. 1;
FIG. 5 is a second side view of the ice machine of FIG. 1 that is opposite the first side view of FIG. 4;
FIG. 6 is a top view of the ice machine of FIG. 1; and,
FIG. 7 is a bottom view of the ice machine of FIG. 1.
The broken line showing is included for the purpose of illustrating and forms no part of the claimed design.

1 Claim, 7 Drawing Sheets

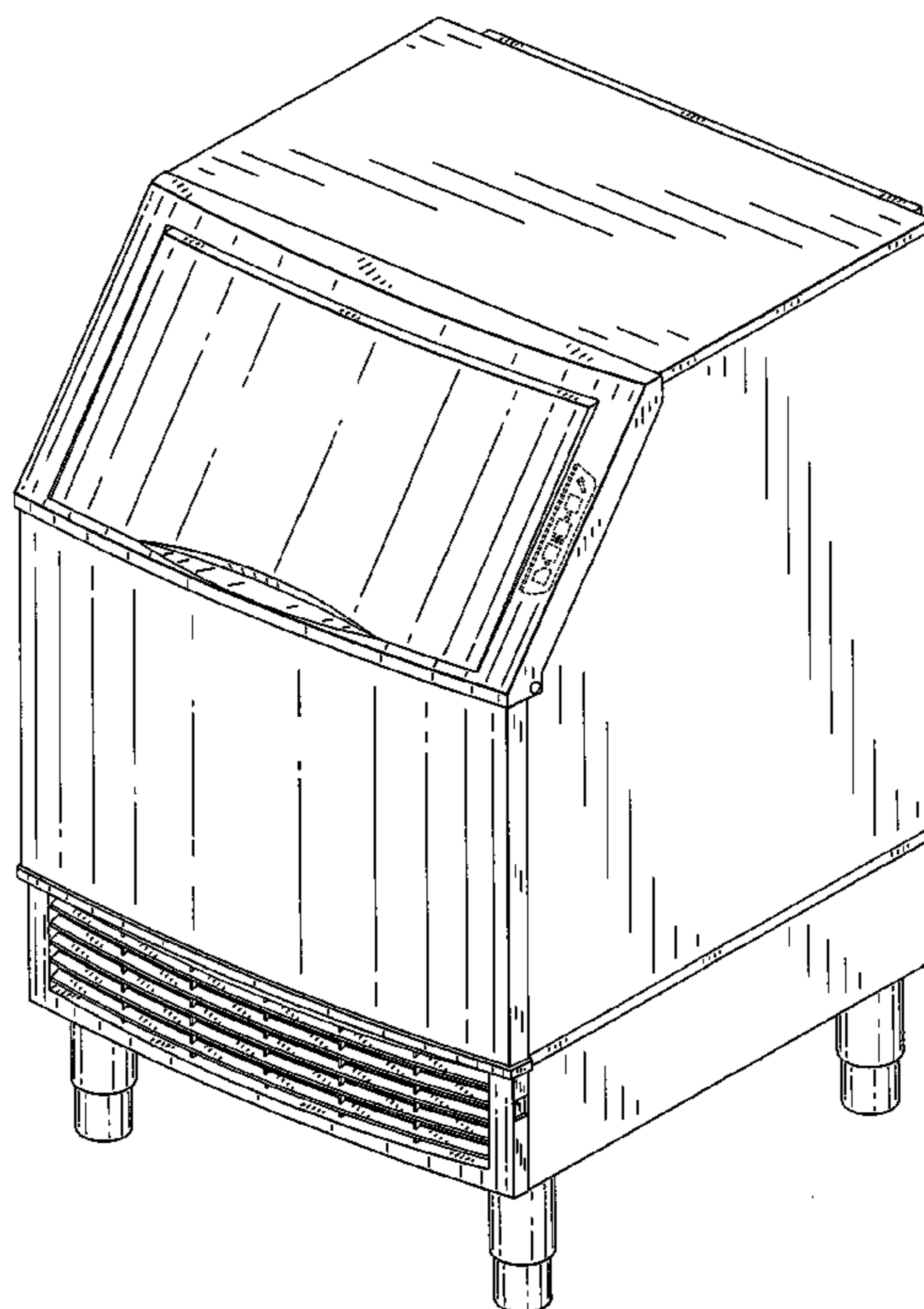

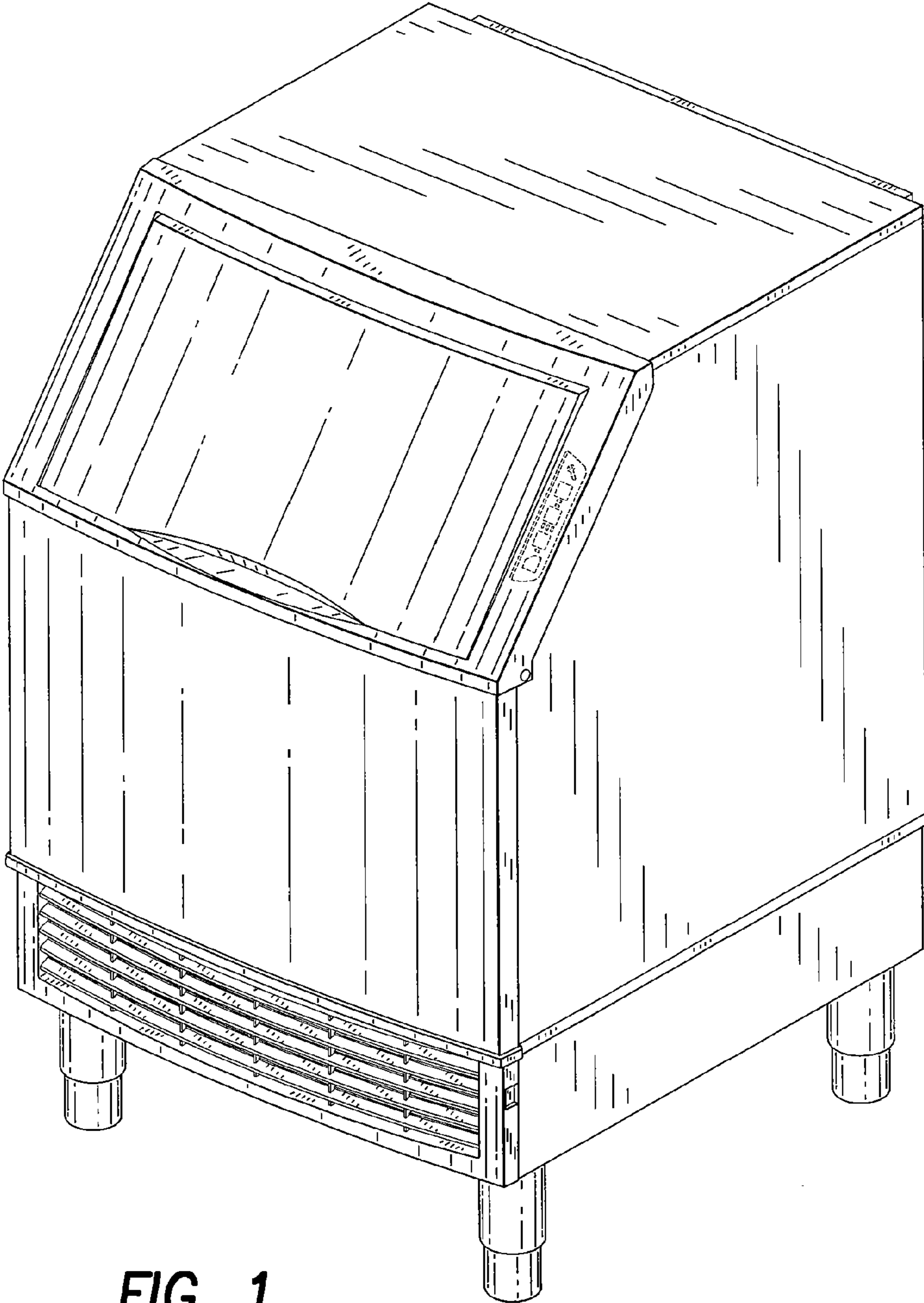

FIG. 1

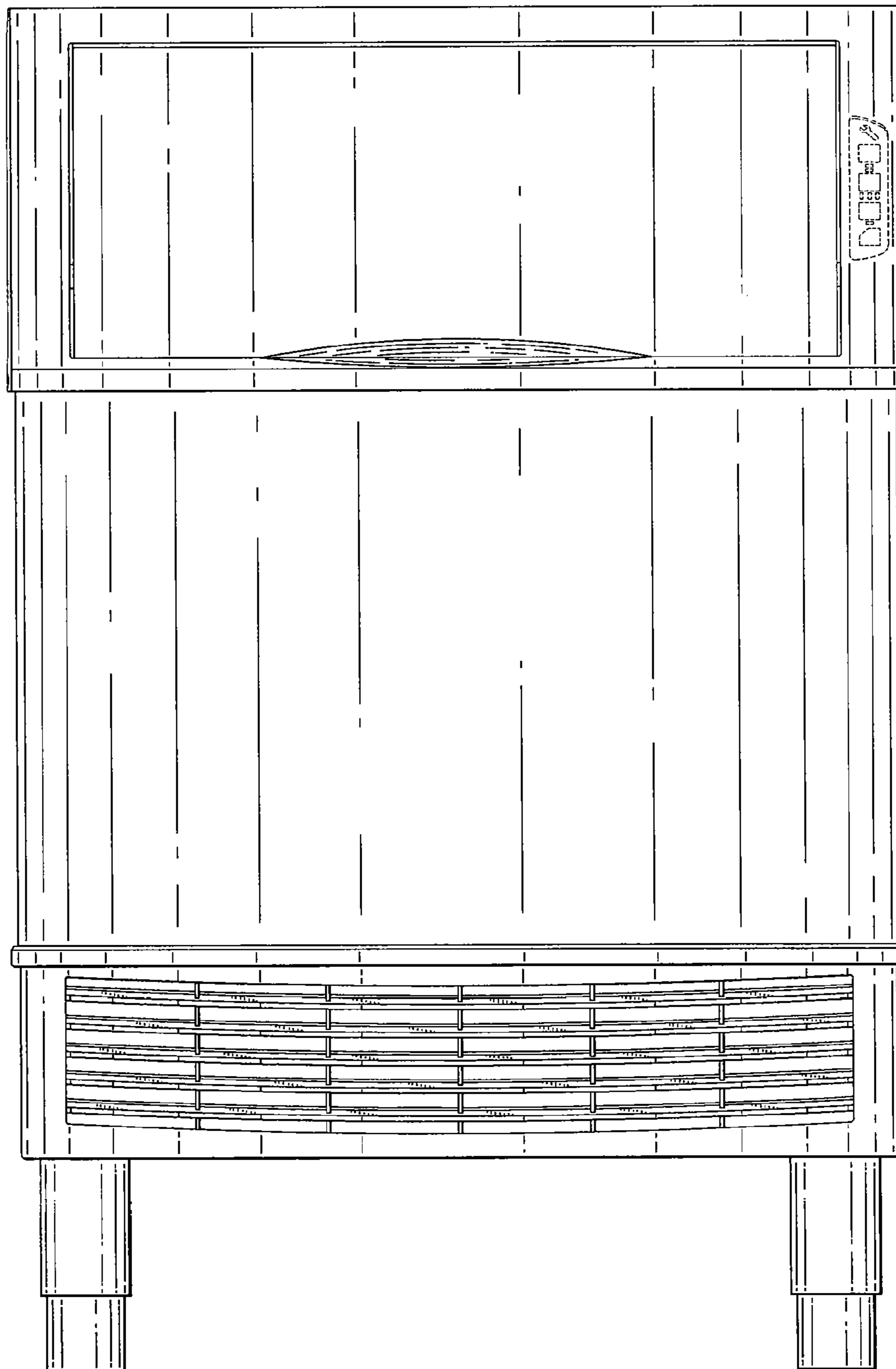

FIG. 2

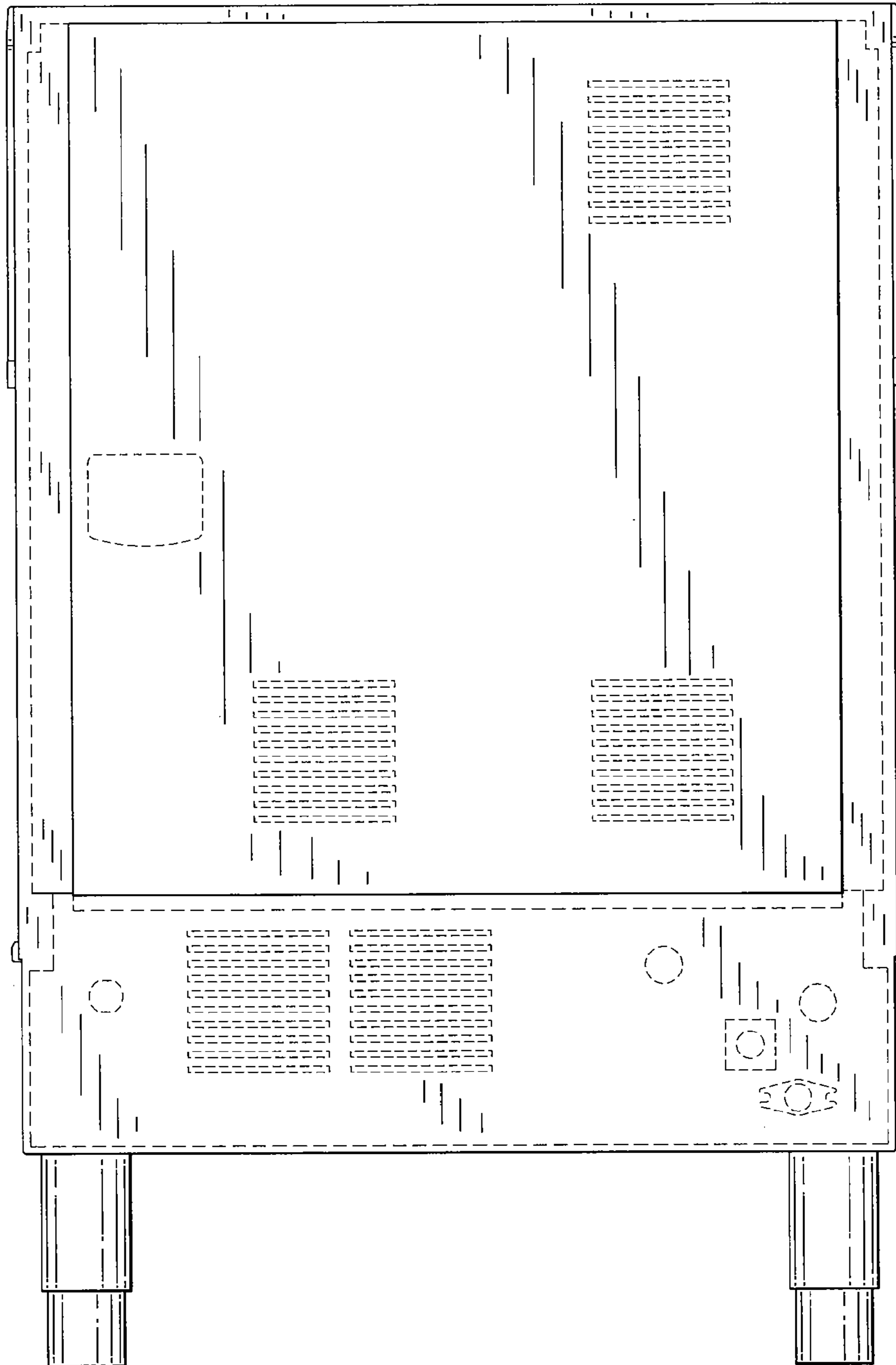

FIG. 3

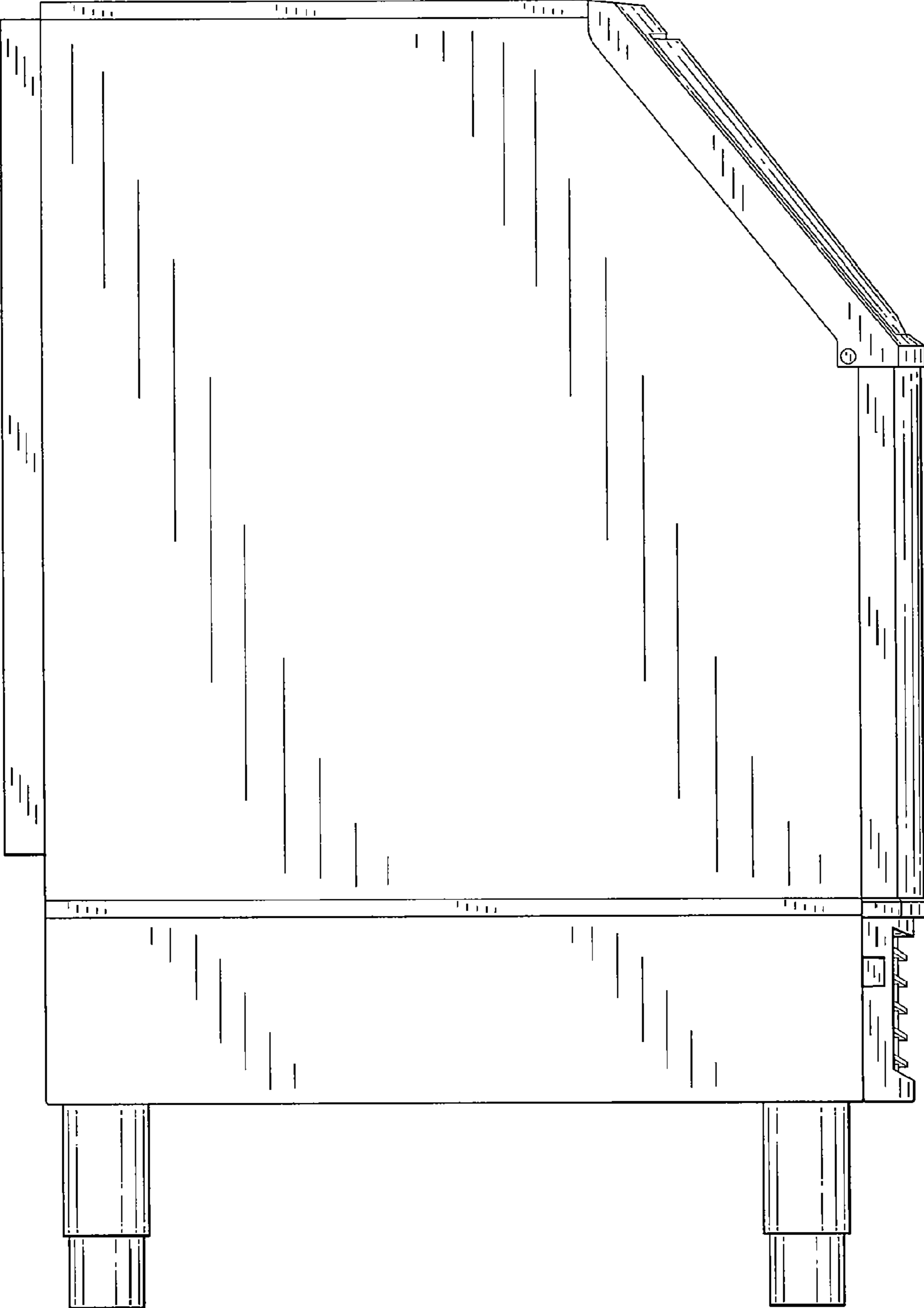

FIG. 4

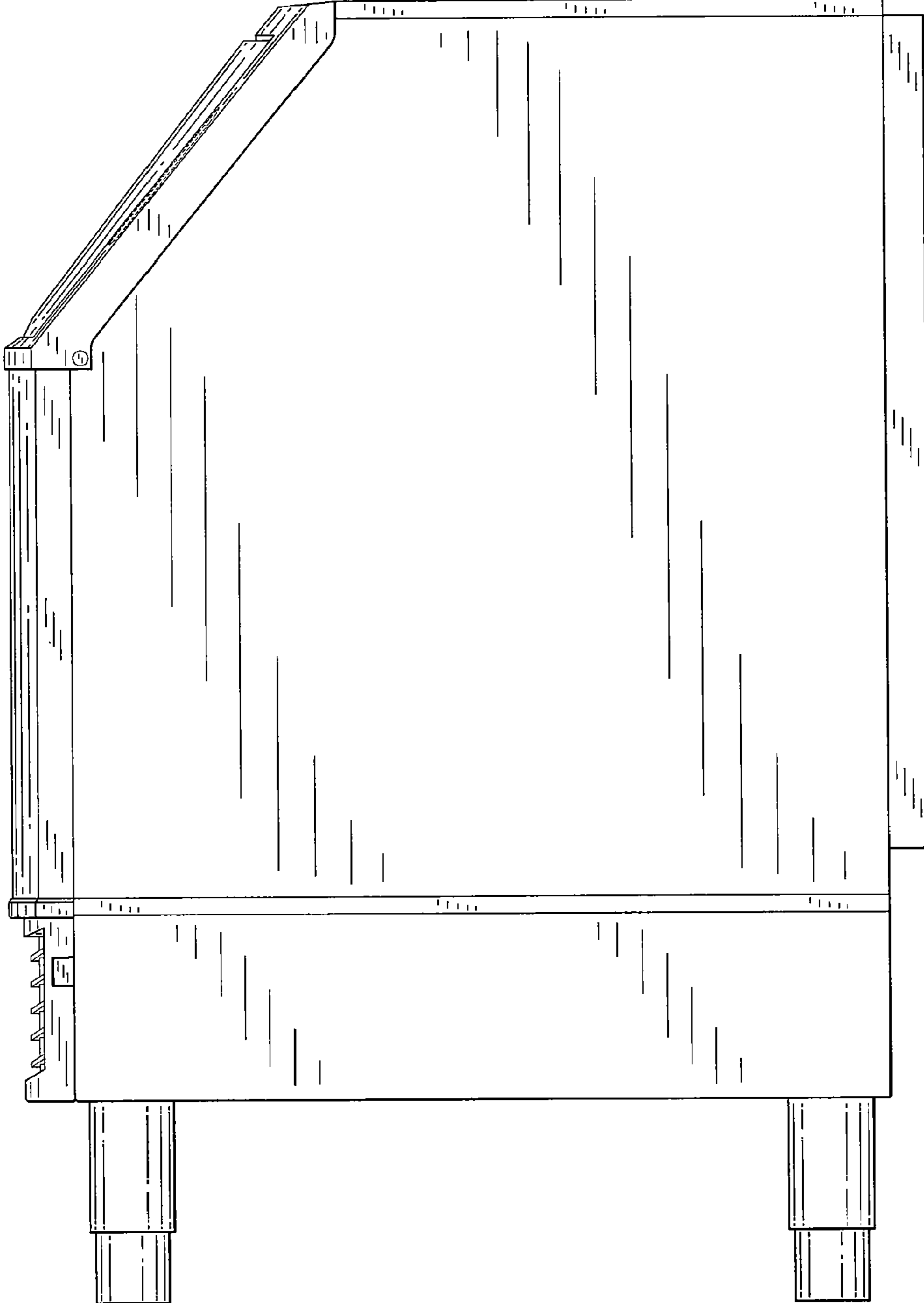

FIG. 5

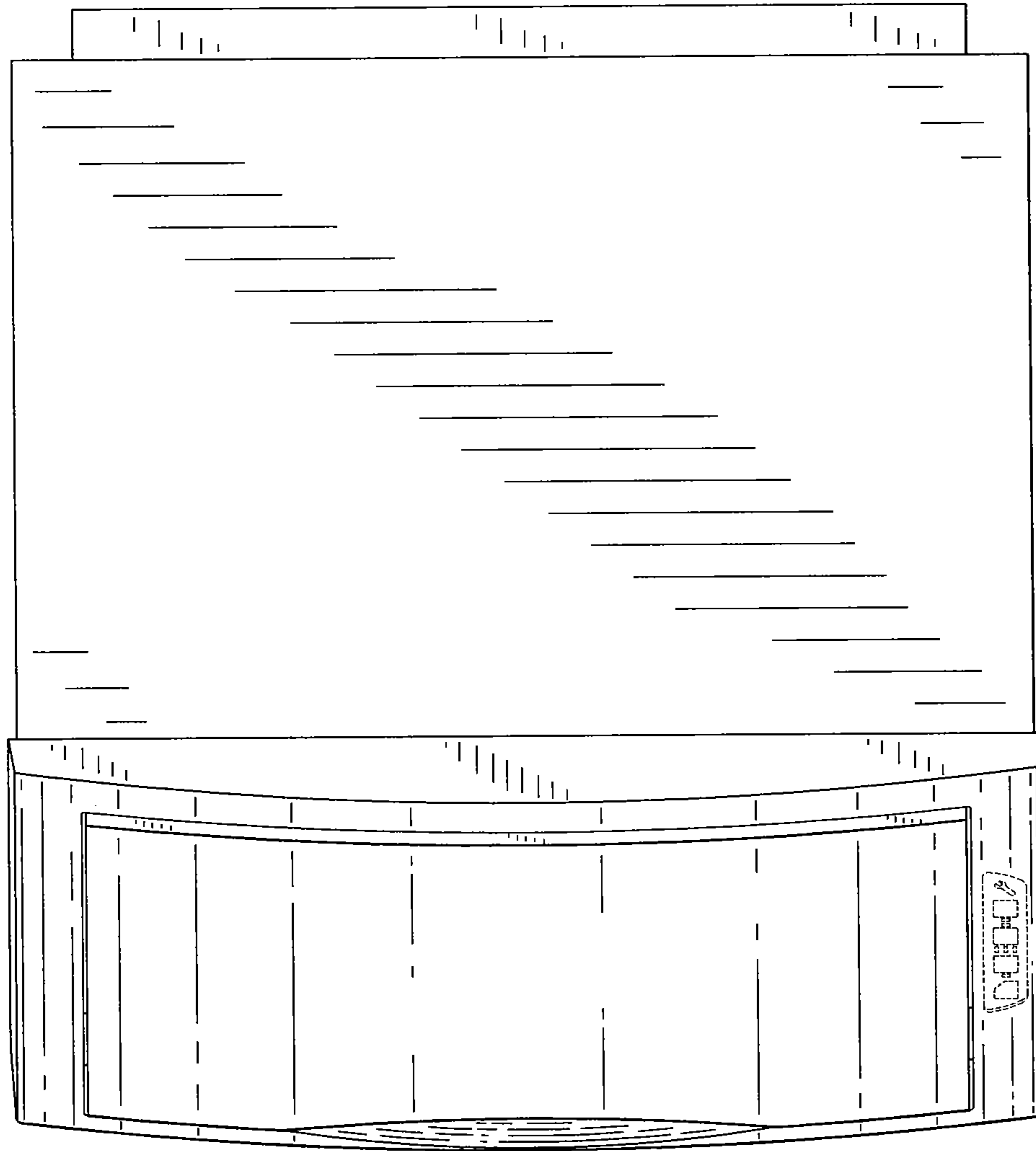

FIG. 6

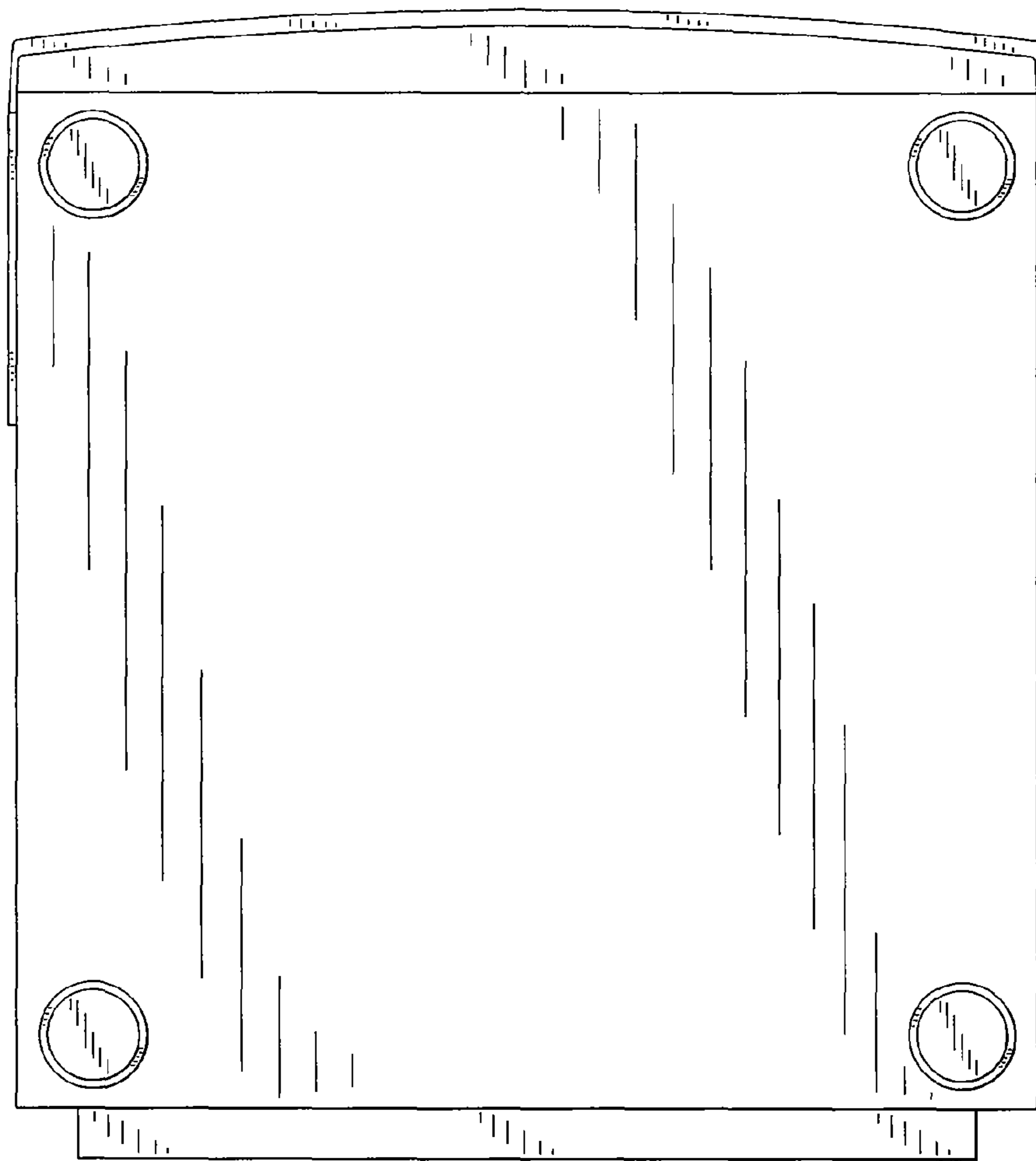

FIG. 7