



US00D691988S

(12) **United States Design Patent**  
**Warner**

(10) **Patent No.:** **US D691,988 S**  
(45) **Date of Patent:** **\*\* Oct. 22, 2013**

(54) **MEDIA PLAYER CHARGING SLING**

(75) Inventor: **Scott K. Warner**, Lehi, UT (US)

(73) Assignee: **Semco Plastic Company**, St. Louis, MO (US)

(\*\*) Term: **14 Years**

(21) Appl. No.: **29/418,178**

(22) Filed: **Apr. 12, 2012**

(51) **LOC (9) Cl.** ..... **14-03**

(52) **U.S. Cl.**  
USPC ..... **D14/238.1**; D14/496

(58) **Field of Classification Search**

USPC ..... D14/203.1–203.8, 496, 238.1, 350, 511,  
D14/217, 250, 251, 432; D3/201, 218, 303;  
D13/184, 103–108; 273/148 B; 463/46,  
463/47; 361/679.3, 679.25; 455/575.1,  
455/578.8; D9/415; 206/461, 305, 320  
See application file for complete search history.

(56) **References Cited**

**U.S. PATENT DOCUMENTS**

D307,829 S \* 5/1990 Hasuike ..... D3/292  
5,404,419 A \* 4/1995 Artis, Jr. .... 392/381  
5,752,205 A \* 5/1998 Dzung et al. .... 455/575.1

6,215,276 B1 \* 4/2001 Smith ..... 320/111  
D492,944 S \* 7/2004 Drakoulis et al. .... D14/238.1  
7,173,184 B2 \* 2/2007 Hull et al. .... 174/58  
7,488,203 B2 \* 2/2009 Leddusire ..... 439/535  
D601,366 S \* 10/2009 Barabas et al. .... D6/466  
D648,225 S \* 11/2011 Peng ..... D9/711  
8,315,416 B2 \* 11/2012 Lee ..... 381/334  
D681,613 S \* 5/2013 Magness et al. .... D14/238.1

\* cited by examiner

*Primary Examiner* — Prabhakar Deshmukh

(74) *Attorney, Agent, or Firm* — Workman Nydegger

(57) **CLAIM**

The ornamental design for a media player charging sling, as shown and described.

**DESCRIPTION**

FIG. 1 is perspective view of a media player charging sling showing my new design in environmental use;  
FIG. 2 is a perspective view thereof;  
FIG. 3 is a front elevational view thereof;  
FIG. 4 is a right-side elevational view thereof, the left side being a mirror image;  
FIG. 5 is a top plan view thereof; and,  
FIG. 6 is a bottom plan view thereof.  
The broken lines in the drawings are included for illustrative purposes only and form no part of the claimed design.

**1 Claim, 4 Drawing Sheets**

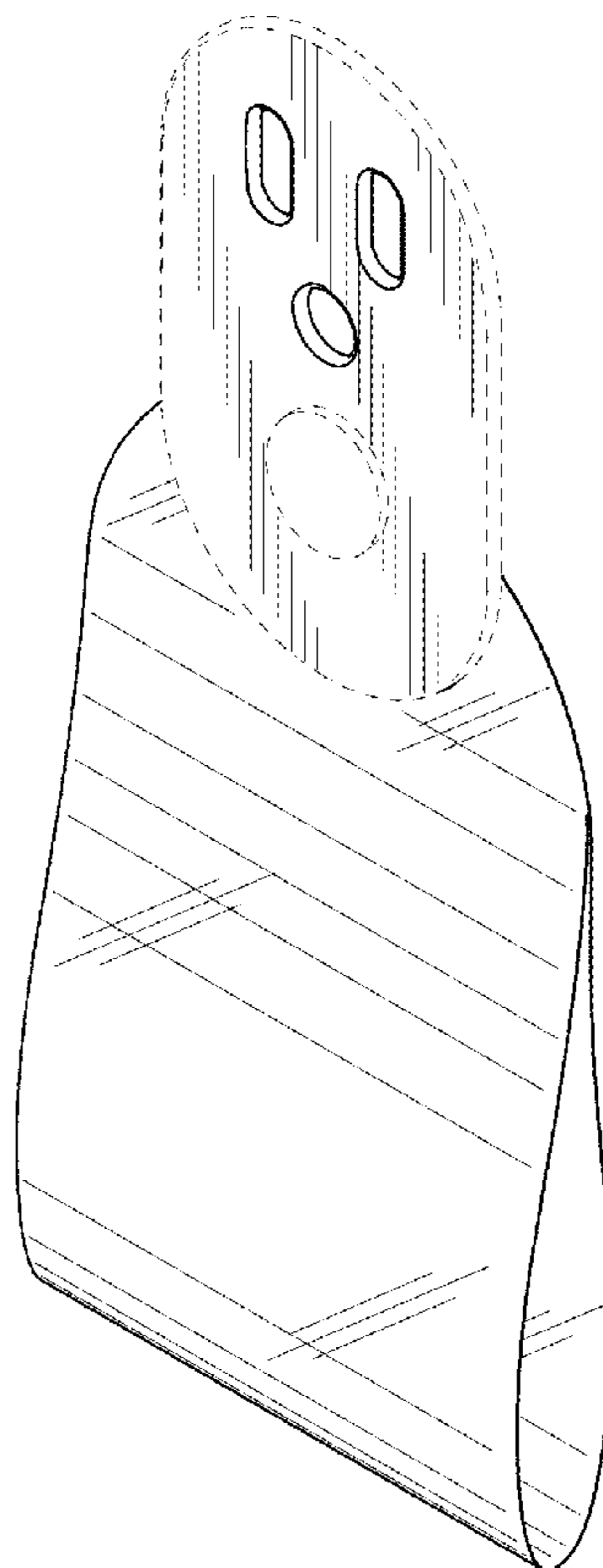

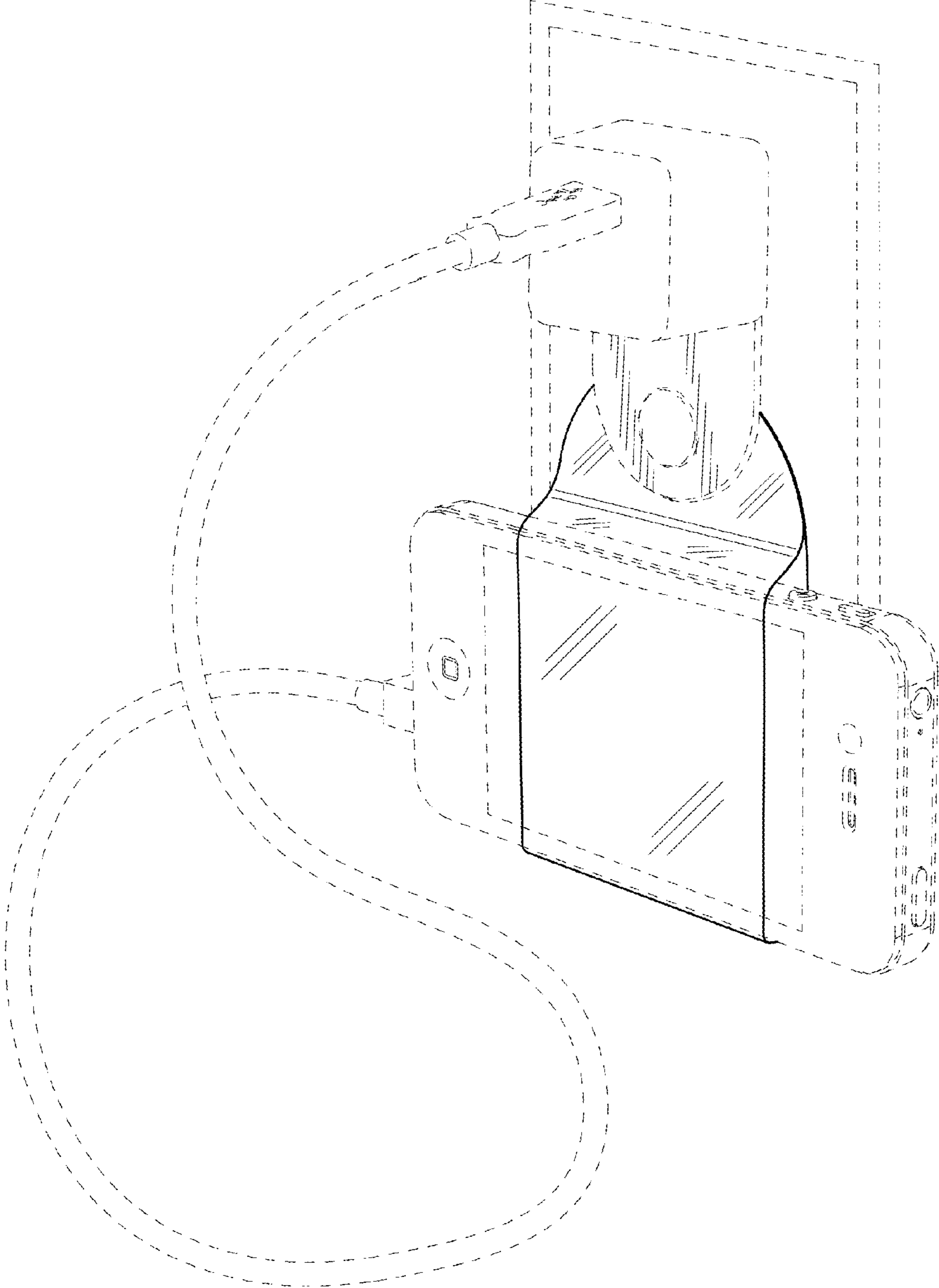

FIG. 1

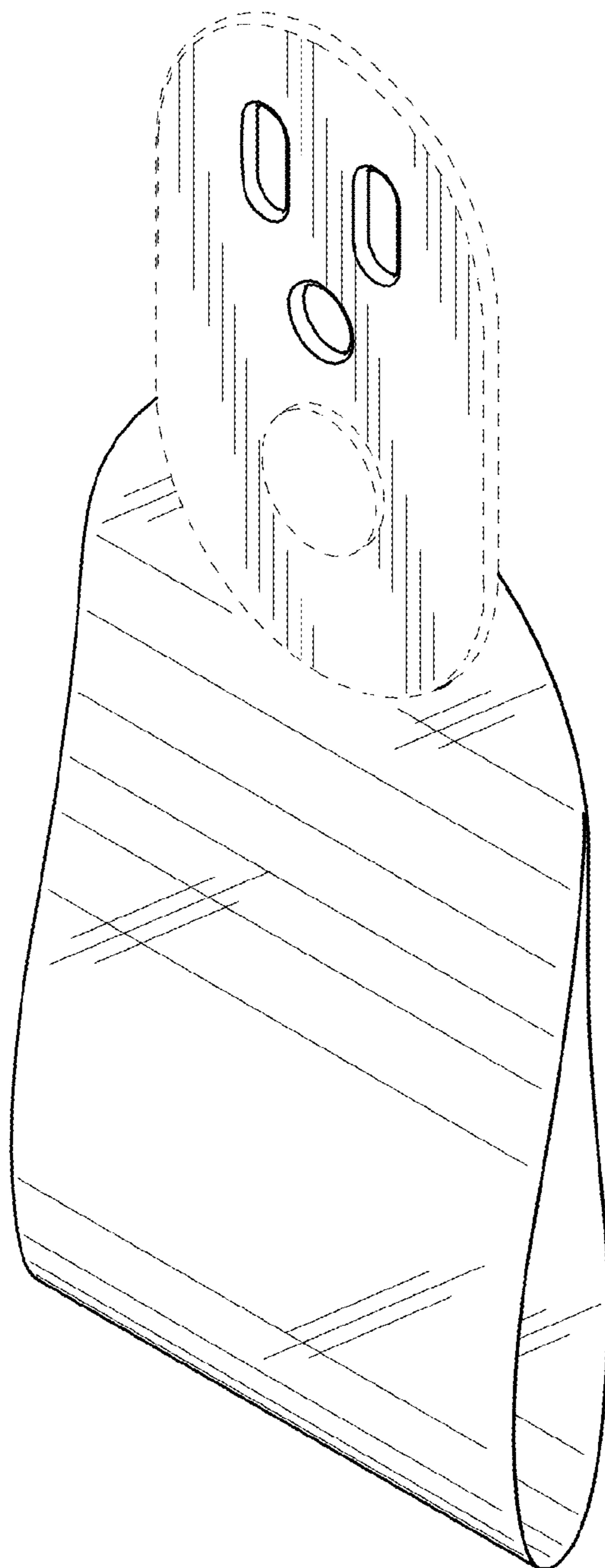

FIG. 2

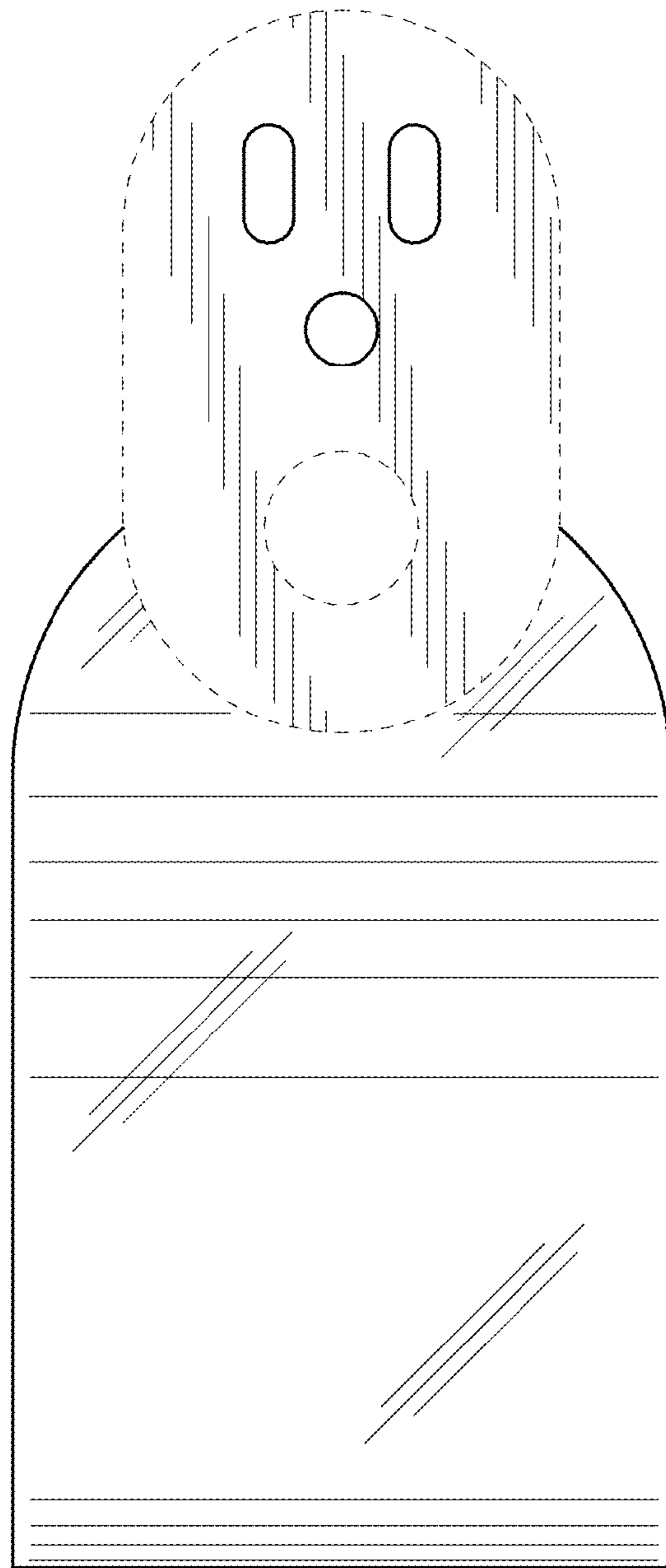

FIG. 3

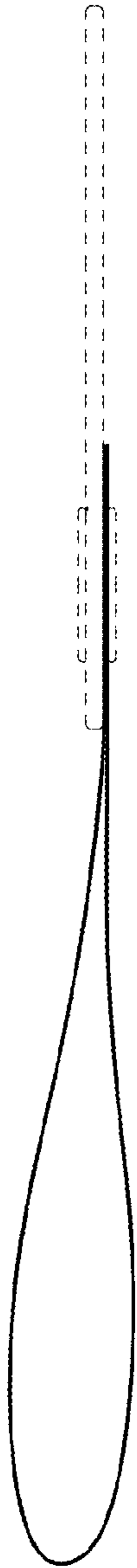

FIG. 4

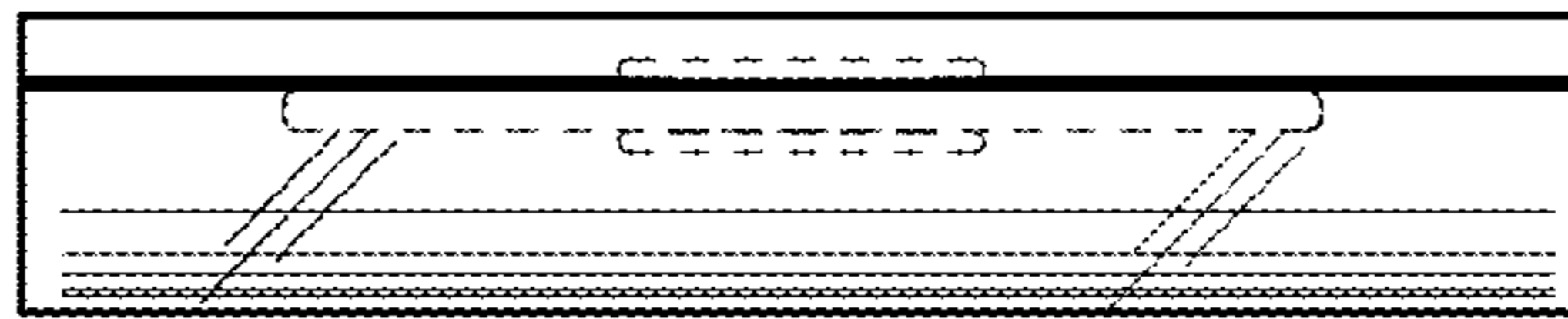

FIG. 5

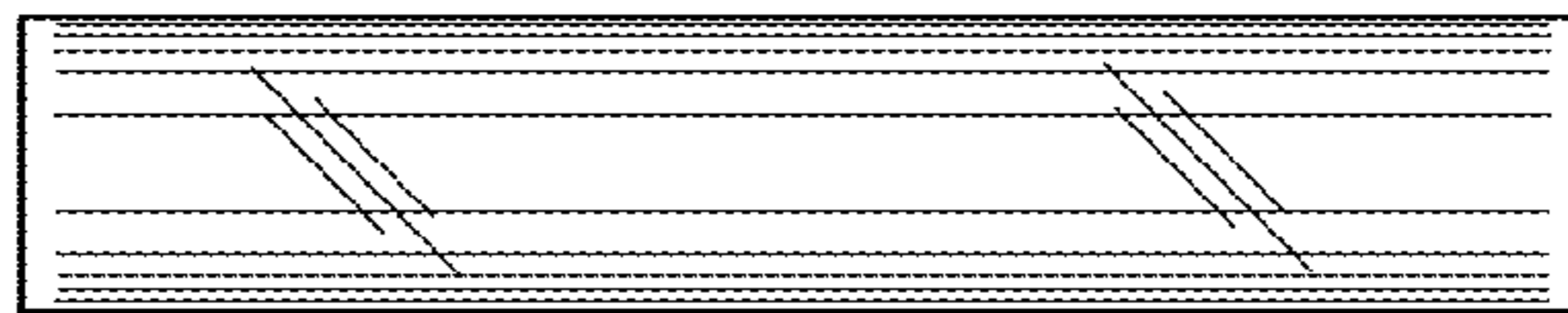

FIG. 6

UNITED STATES PATENT AND TRADEMARK OFFICE  
**CERTIFICATE OF CORRECTION**

PATENT NO. : D691,988 S  
APPLICATION NO. : 29/418178  
DATED : October 22, 2013  
INVENTOR(S) : Warner

Page 1 of 1

It is certified that error appears in the above-identified patent and that said Letters Patent is hereby corrected as shown below:

Title Page

Under Description, include --BE IT KNOWN that I, Scott K. Warner, have invented a new, original, and ornamental design for a media player charging sling, as set forth in the following specification, reference being made to the accompanying drawings which form a part thereof--

Signed and Sealed this  
Eleventh Day of February, 2014



Michelle K. Lee  
*Deputy Director of the United States Patent and Trademark Office*