



US00D691986S

(12) **United States Design Patent**
Amiya

(10) **Patent No.:** **US D691,986 S**

(45) **Date of Patent:** **** Oct. 22, 2013**

(54) **AUDIO MIXER**

(71) Applicant: **Yamaha Corporation**, Shizuoka (JP)

(72) Inventor: **Eizo Amiya**, Shizuoka (JP)

(73) Assignee: **Yamaha Corporation**, Shizuoka (JP)

(**) Term: **14 Years**

(21) Appl. No.: **29/436,811**

(22) Filed: **Nov. 9, 2012**

(51) **LOC (9) Cl.** **14-03**

(52) **U.S. Cl.**
USPC **D14/217**

(58) **Field of Classification Search**
USPC D14/162, 167, 168, 175, 188, 196-198,
D14/217, 257, 258, 434, 496; 13/163, 164;
84/625, 660, 697; 381/119; 455/350
See application file for complete search history.

(56) **References Cited**

U.S. PATENT DOCUMENTS

D471,173 S * 3/2003 Takita et al. D14/162
D499,394 S * 12/2004 Suzuki D14/217
D511,767 S * 11/2005 Ishizaki et al. D14/217
D555,639 S * 11/2007 Amiya D14/217

D573,587 S * 7/2008 Amiya D14/217
D584,282 S * 1/2009 Ishizaki et al. D14/188
D609,219 S * 2/2010 Ito D14/217

* cited by examiner

Primary Examiner — Keli L Hill

(74) *Attorney, Agent, or Firm* — Sughrue Mion, PLLC

(57) **CLAIM**

The ornamental design for an audio mixer, as shown and described.

DESCRIPTION

FIG. 1 is a front perspective view of the front, top and right side of an audio mixer showing my new design;
FIG. 2 is a rear perspective view of the rear, bottom and left side thereof;
FIG. 3 is a front view thereof;
FIG. 4 is a rear view thereof;
FIG. 5 is a left side view thereof;
FIG. 6 is a right side view thereof;
FIG. 7 is a top plan view thereof; and,
FIG. 8 is a bottom view thereof.
Broken lines are used to show portions of the audio mixer that are not being claimed, and thus form no part of the claimed invention.

1 Claim, 6 Drawing Sheets

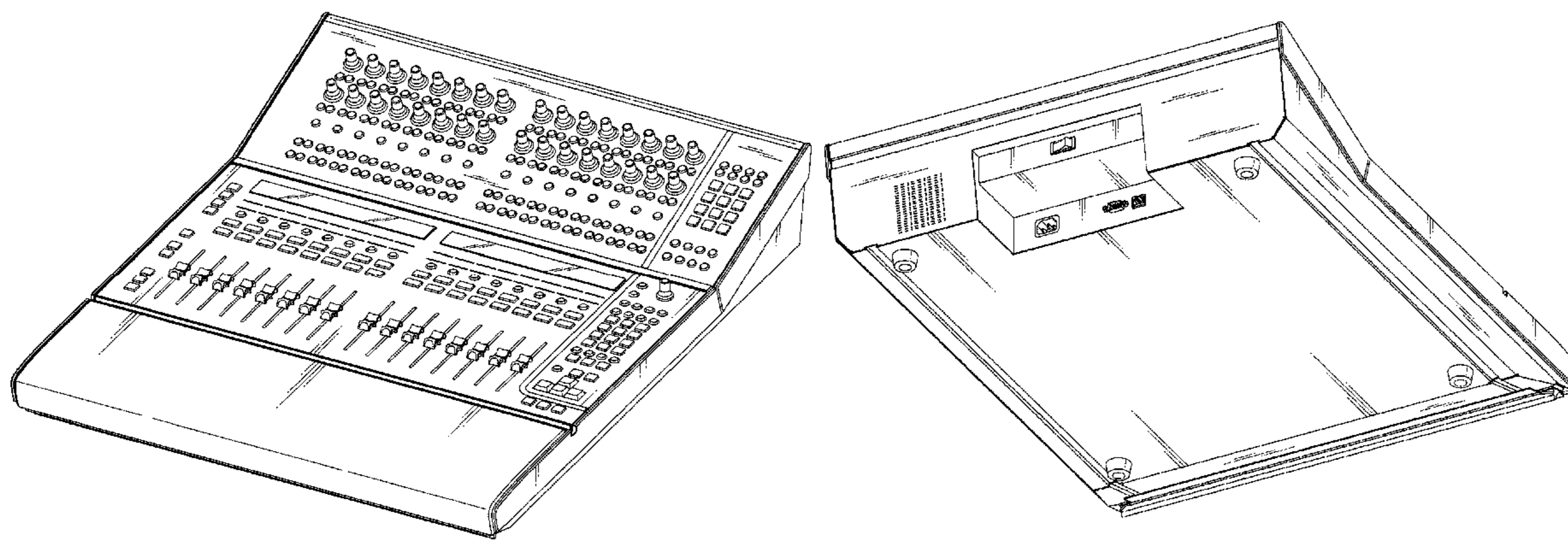

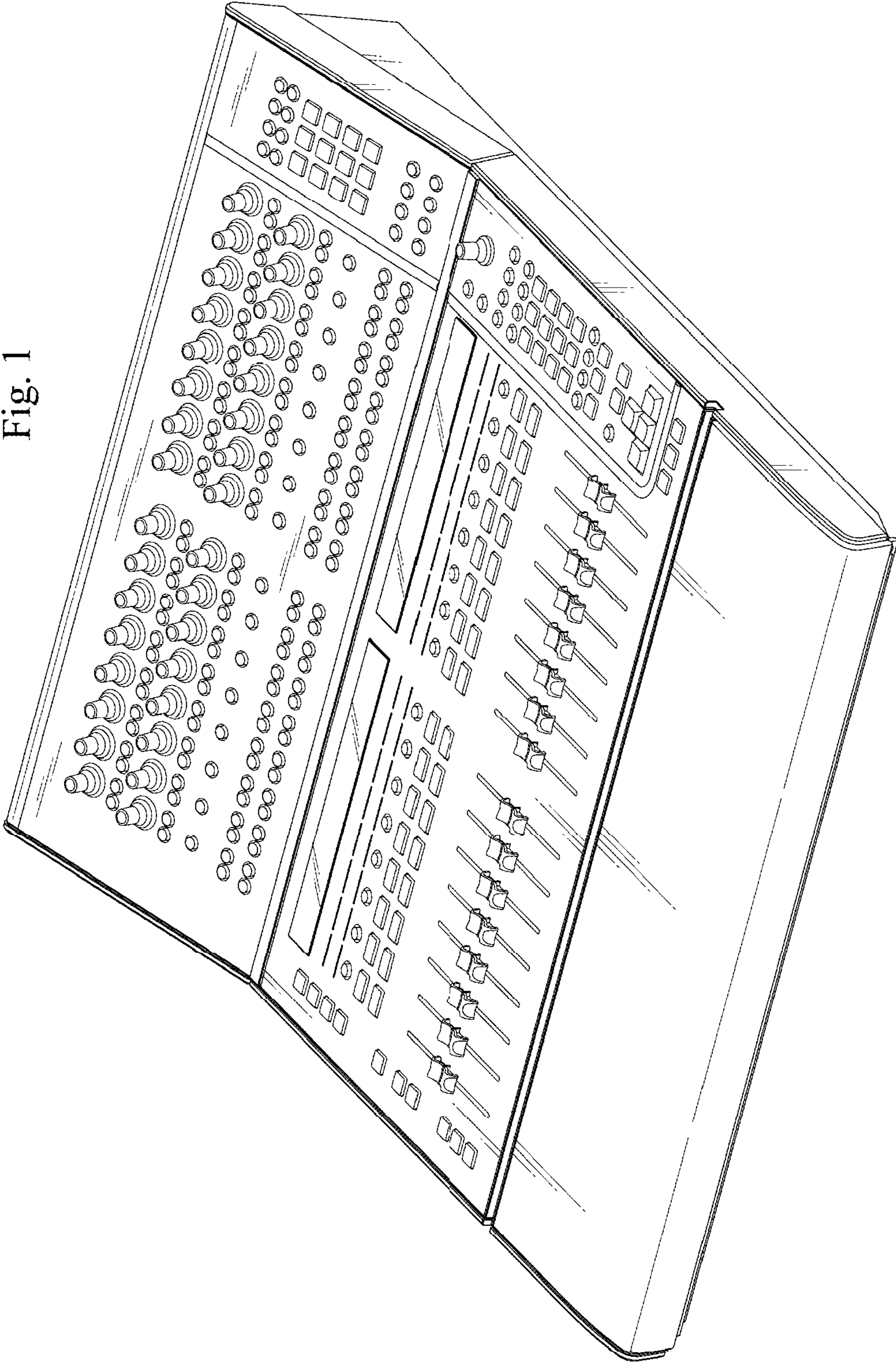

Fig. 1

Fig. 2

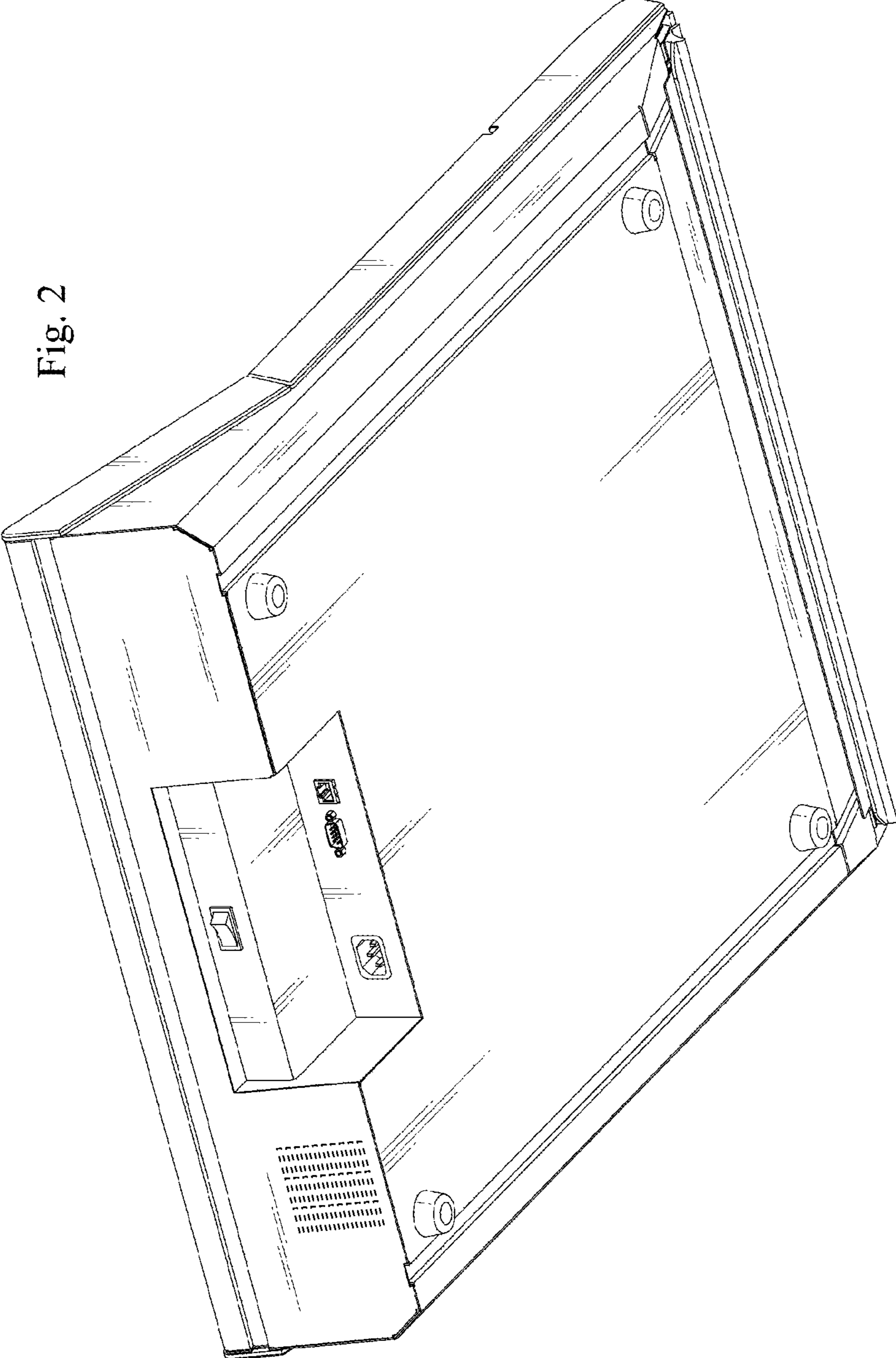

Fig. 3

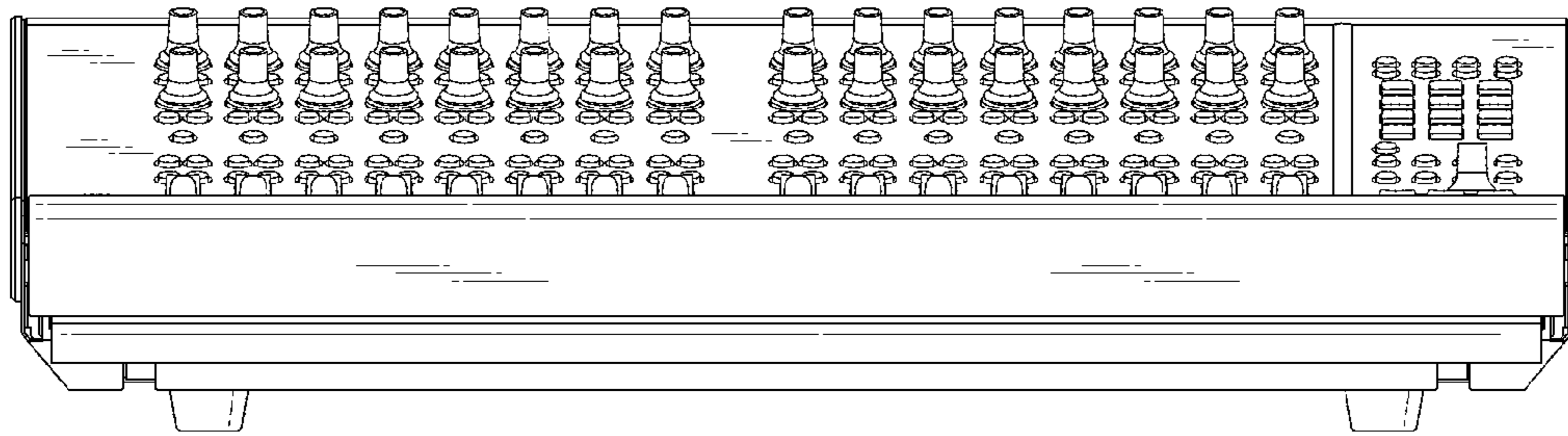

Fig. 4

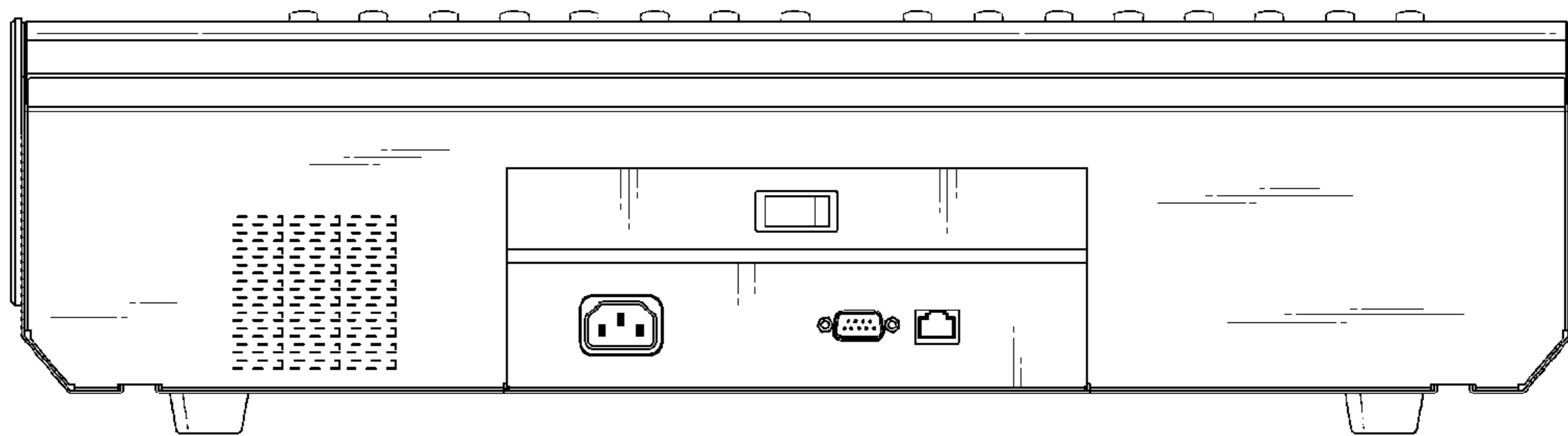

Fig. 5

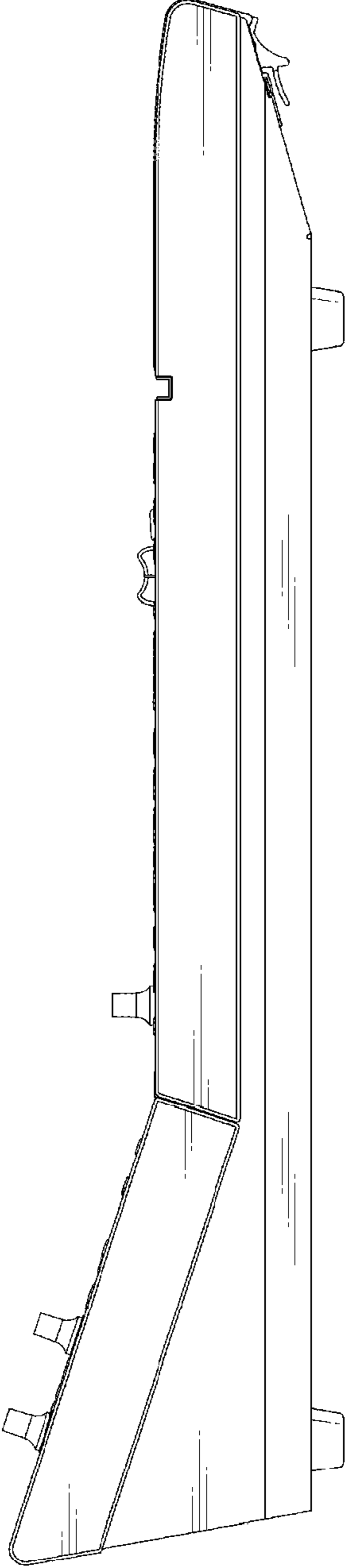

Fig. 6

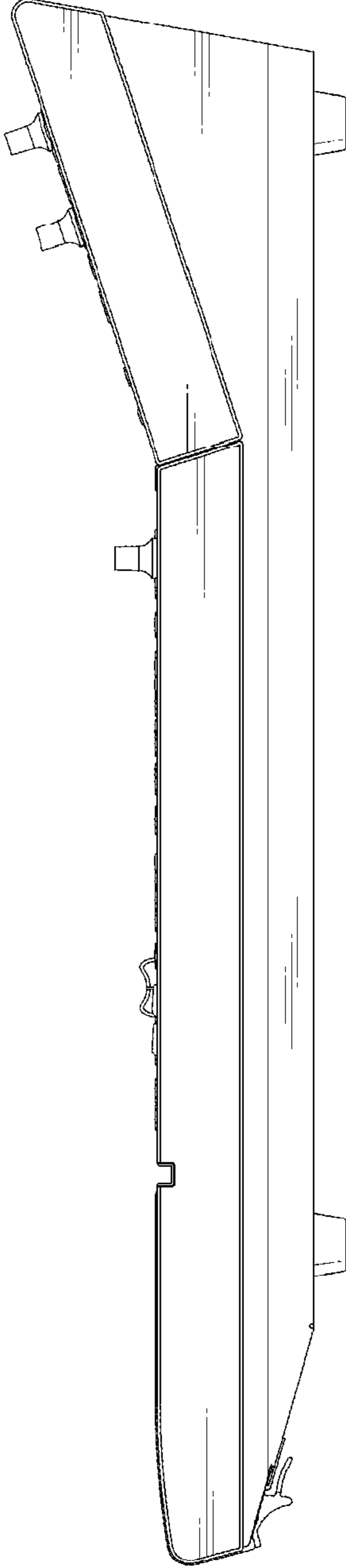

Fig. 7

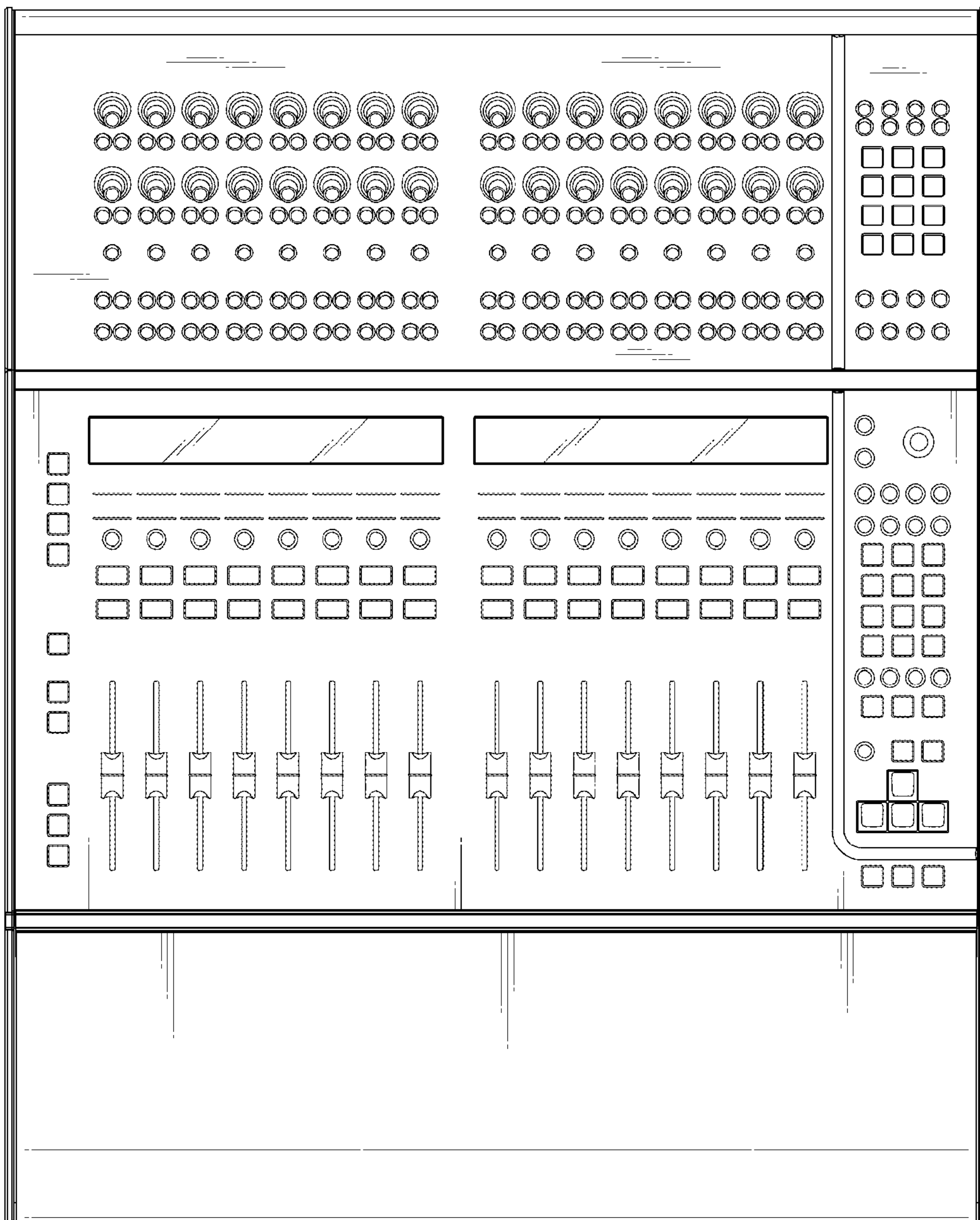

Fig. 8

