



US00D691980S

(12) **United States Design Patent**
Park

(10) **Patent No.:** **US D691,980 S**

(45) **Date of Patent:** **** Oct. 22, 2013**

(54) **MOBILE TERMINAL**

(75) Inventor: **Jun-Sang Park**, Anyang-si (KR)

(73) Assignee: **Samsung Electronics Co., Ltd.**,
Suwon-si (KR)

(**) Term: **14 Years**

(21) Appl. No.: **29/416,651**

(22) Filed: **Mar. 26, 2012**

(30) **Foreign Application Priority Data**

Oct. 14, 2011 (KR) 30-2011-0042809

(51) **LOC (9) Cl.** **14-03**

(52) **U.S. Cl.**
USPC **D14/138 G; D14/341**

(58) **Field of Classification Search**
USPC D14/138 G, 138 AD, 341, 346, 138 R,
D14/138 AC, 496, 203.1, 203.4, 203.7, 248,
D14/218; 455/575.1, 556.2, 575.3, 575.4;
D21/517; 379/433.01, 433.04; D10/65,
D10/78, 104; D13/168
See application file for complete search history.

(56) **References Cited**

U.S. PATENT DOCUMENTS

D578,526 S *	10/2008	Hwangbo	D14/341
D590,822 S *	4/2009	Leith et al.	D14/248
D617,793 S *	6/2010	Chiang et al.	D14/341
D631,469 S *	1/2011	Demskie et al.	D14/218
D639,805 S *	6/2011	Song et al.	D14/341
D640,578 S *	6/2011	Aihara et al.	D10/65
D645,435 S *	9/2011	Kim et al.	D14/138 G
D645,441 S *	9/2011	Choe et al.	D14/138 G
D645,833 S *	9/2011	Seflic et al.	D14/138 G
D657,331 S *	4/2012	Jung	D14/138 G

D658,147 S *	4/2012	Yoon	D14/138 G
D659,664 S *	5/2012	Park et al.	D14/138 AD
D659,692 S *	5/2012	Jung et al.	D14/341
8,199,478 B2 *	6/2012	Liang et al.	361/679.3
D665,370 S *	8/2012	Chung	D14/138 AD

(Continued)

OTHER PUBLICATIONS

HTC HD7 telephone, announced Oct. 2010, [online], [site visited May 3, 2013]. Available from Internet, <URL: http://www.gsmarena.com/htc_hd7-3338.php>.*

(Continued)

Primary Examiner — Jeffrey D Asch

(74) *Attorney, Agent, or Firm* — NSIP Law

(57) **CLAIM**

The ornamental design for a mobile terminal, as shown and described.

DESCRIPTION

FIG. 1 is a perspective view of a mobile terminal;
FIG. 2 is a front view of the mobile terminal of FIG. 1;
FIG. 3 is a rear view of the mobile terminal of FIG. 1;
FIG. 4 is a left-side view of the mobile terminal of FIG. 1;
FIG. 5 is a right-side view of the mobile terminal of FIG. 1;
FIG. 6 is a top plan view of the mobile terminal of FIG. 1;
FIG. 7 is a bottom plan view of the mobile terminal of FIG. 1;
FIG. 8 is a perspective view of the rear of the mobile terminal of FIG. 1; and,
FIG. 9 is a perspective view of the rear of the mobile terminal of FIG. 1 in which an upright position of a cover of the mobile phone is illustrated to further show an ornamental aspect of my claimed design.

1 Claim, 7 Drawing Sheets

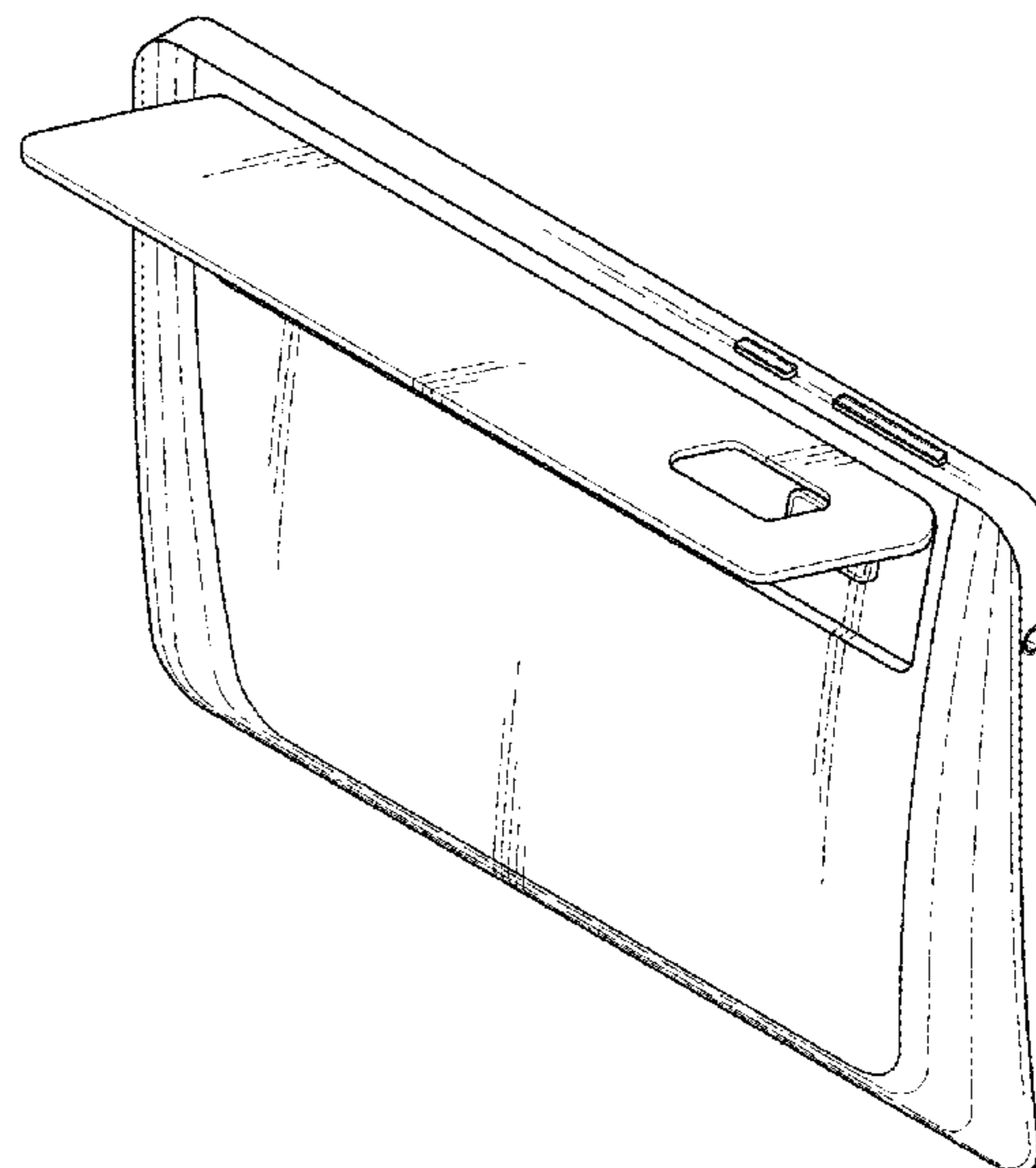

(56)

References Cited

U.S. PATENT DOCUMENTS

D669,070 S * 10/2012 Hsu et al. D14/341
D669,469 S * 10/2012 Kang D14/341
D677,640 S * 3/2013 Kim et al. D14/138 G
D677,660 S * 3/2013 Groene et al. D14/341
D678,877 S * 3/2013 Groene et al. D14/341
D681,580 S * 5/2013 Park D14/138 G
D681,582 S * 5/2013 Park D14/138 G
D681,583 S * 5/2013 Park D14/138 G
2011/0117977 A1* 5/2011 Yamashita et al. 455/575.4

OTHER PUBLICATIONS

HTC ThunderBolt 4G telephone, announced Jan. 2011, [online], [site visited May 3, 2013]. Available from Internet, <URL: http://www.gsmarena.com/htc_thunderbolt_4g-3703.php>.*
Huawei IDEOS S7 telephone, announced Jan. 2010, [online], [site visited May 3, 2013]. Available from Internet, <URL: http://www.gsmarena.com/huawei_ideos_s7-3740.php>.*
Samsung Galaxy Tab 8.9 4G P7320T telephone, announced Q1/2012, [online], [site visited May 3, 2013]. Available from Internet, <URL: http://www.gsmarena.com/samsung_galaxy_tab_8_9_4g_p7320t-4769.php>.*

* cited by examiner

FIG. 1

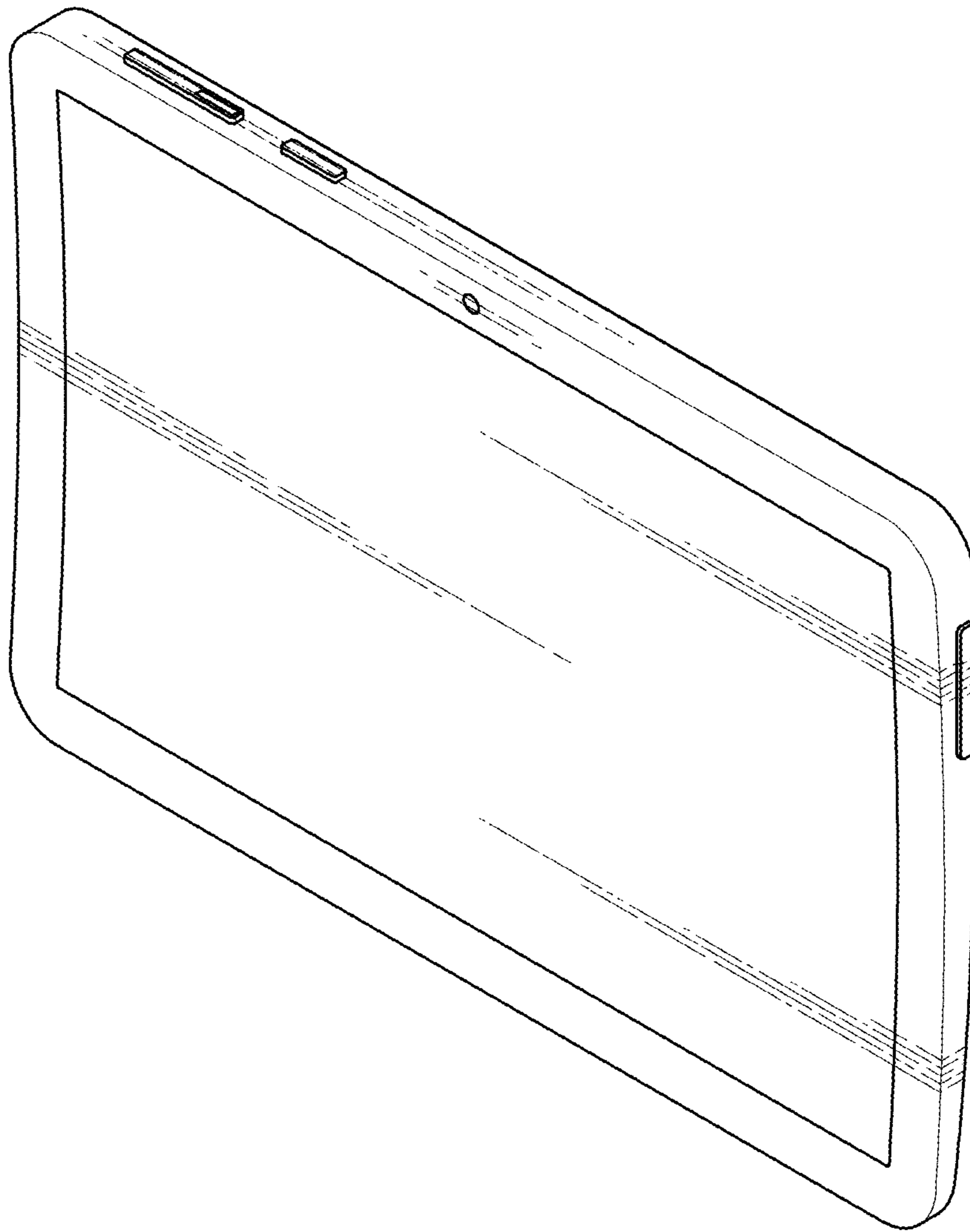

FIG. 2

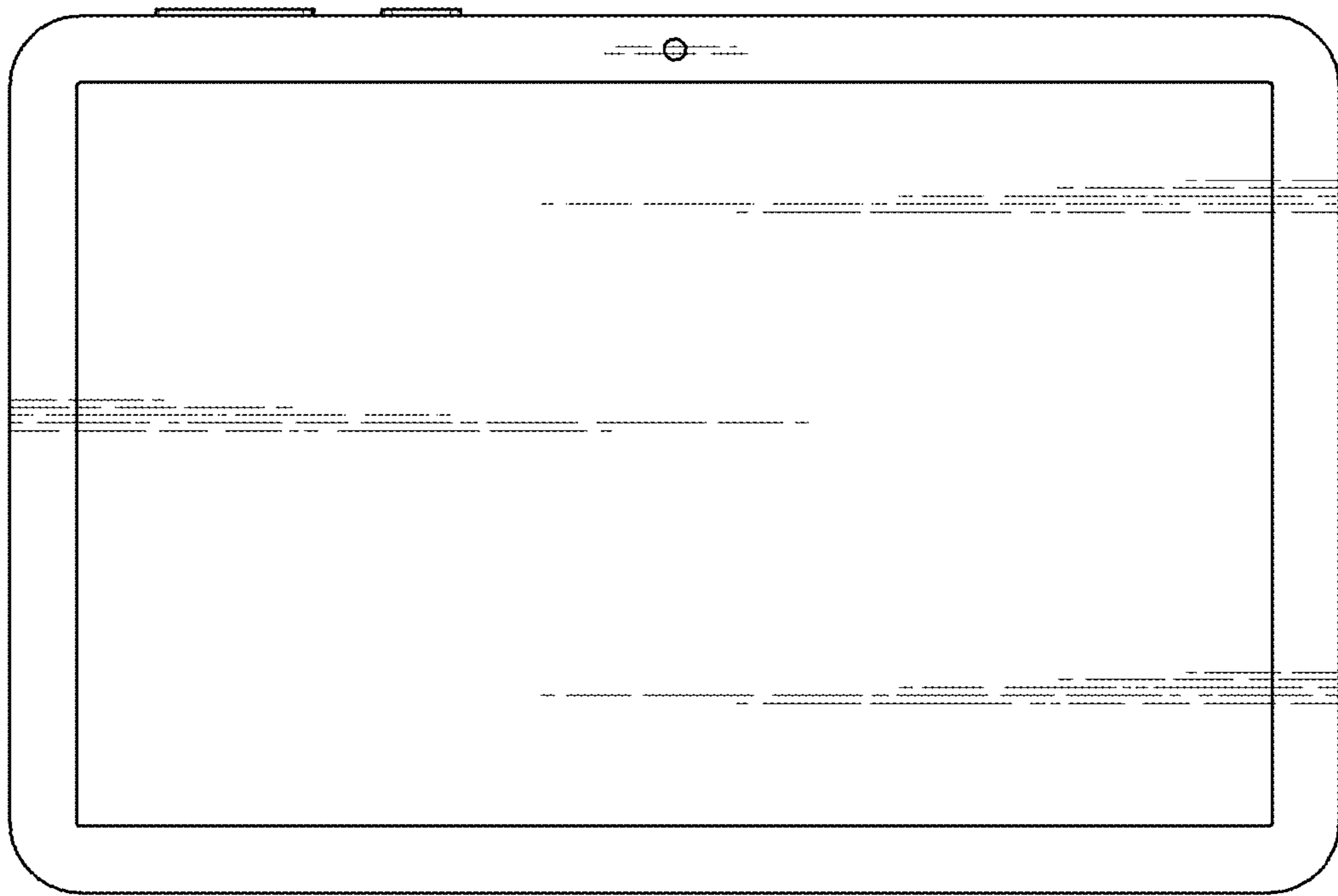

FIG. 3

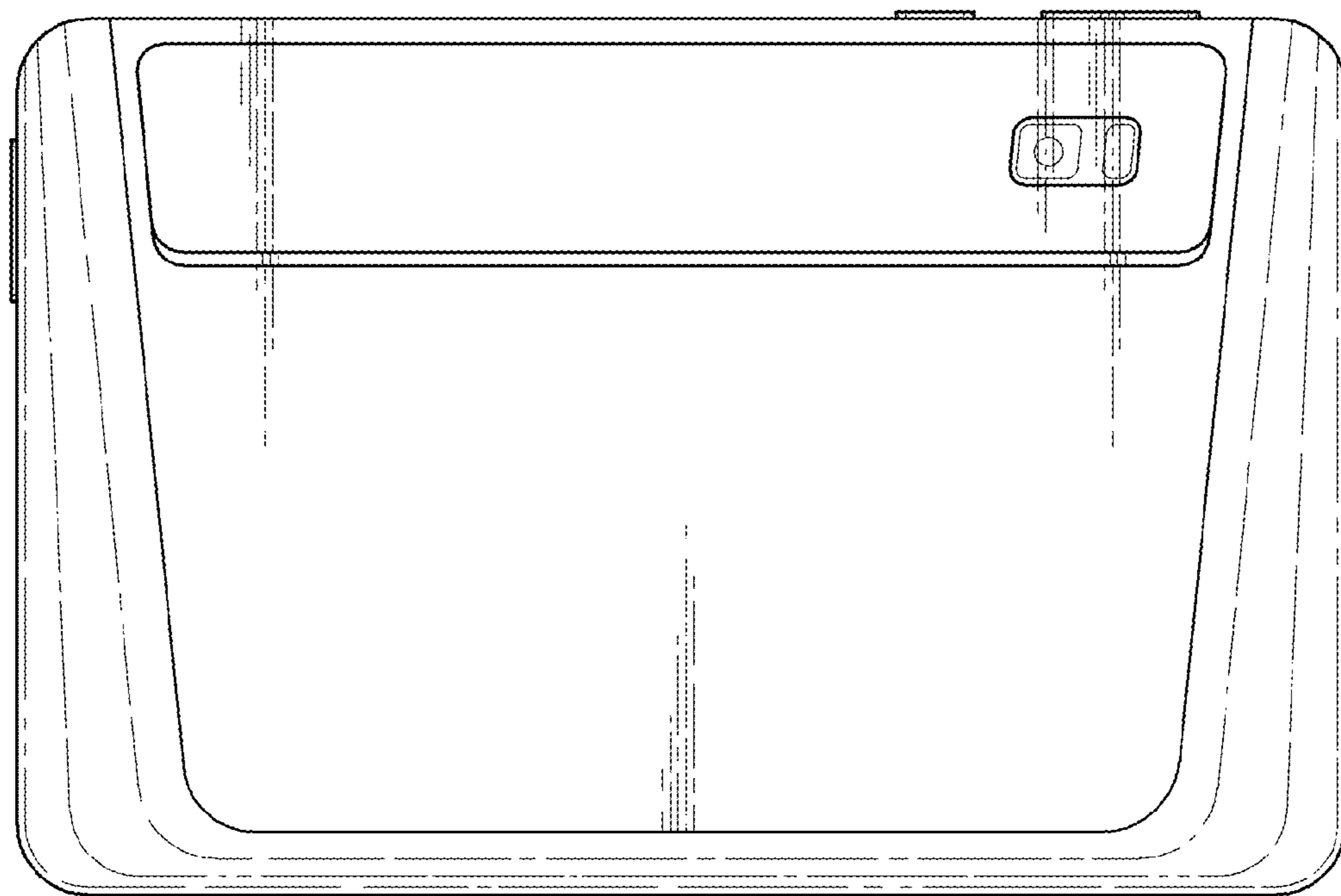

FIG. 4

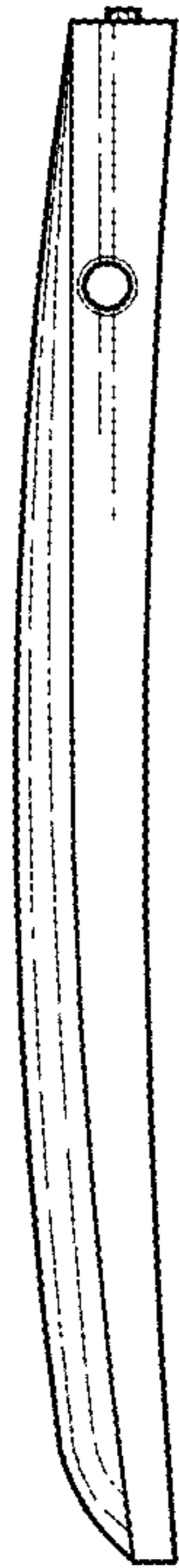

FIG. 5

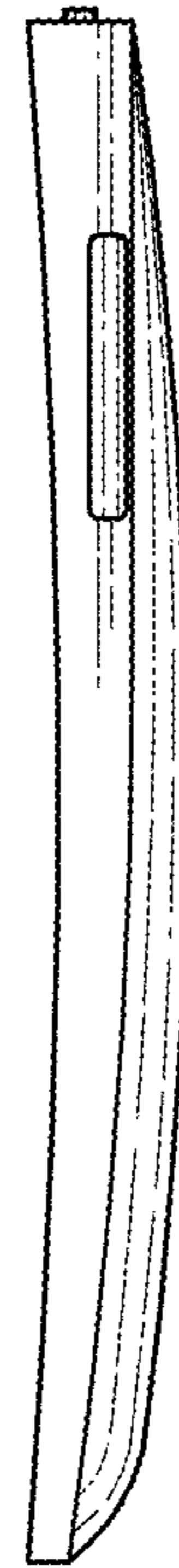

FIG. 6



FIG. 7



FIG. 8

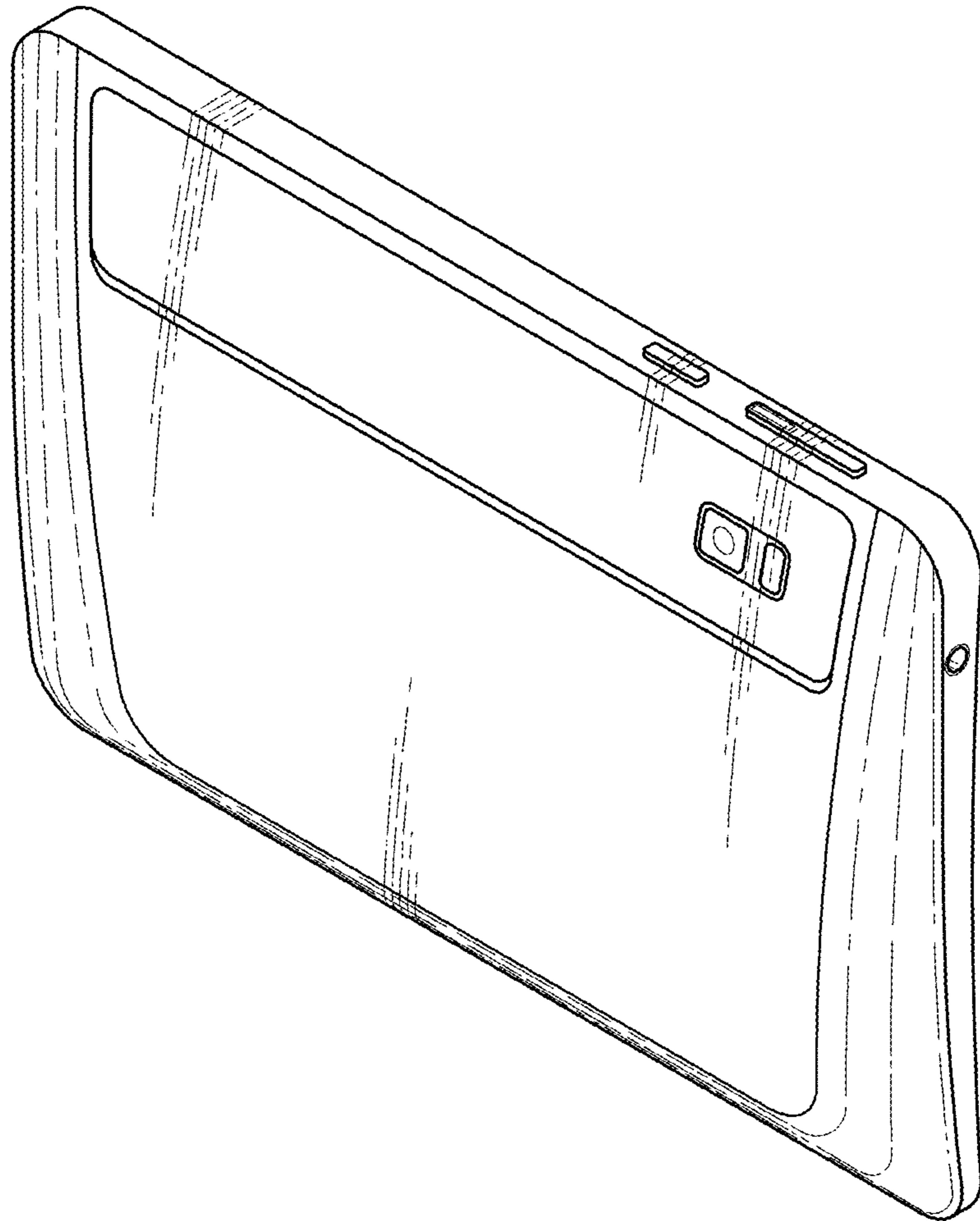

FIG. 9

