



US00D691970S

(12) **United States Design Patent**
Wu et al.

(10) **Patent No.:** **US D691,970 S**

(45) **Date of Patent:** **** Oct. 22, 2013**

(54) **CONTROL UNIT CASING**

(71) Applicants: **Xianyi Wu**, Singapore (SG); **Sean Sun**,
Shenzhen (CN)

(72) Inventors: **Xianyi Wu**, Singapore (SG); **Sean Sun**,
Shenzhen (CN)

(73) Assignee: **D.Light Design, Inc.**, Grand Cayman
(KY)

(**) Term: **14 Years**

(21) Appl. No.: **29/443,205**

(22) Filed: **Jan. 14, 2013**

(51) **LOC (9) Cl.** **14-03**

(52) **U.S. Cl.**
USPC **D13/168**

(58) **Field of Classification Search**
USPC D13/162, 168; D14/218; 200/5 A, 5 R,
200/293; 340/4.3, 4.42, 12.22, 12.23,
340/12.24, 12.29, 12.3, 12.55, 13.2, 13.21,
340/13.24; 341/176; 345/169; 381/105;
315/158; 455/352; 700/17, 65, 83

See application file for complete search history.

(56) **References Cited**

U.S. PATENT DOCUMENTS

D350,494	S	*	9/1994	Hwang	D10/106.1
D405,424	S	*	2/1999	Winkler et al.	D13/168
5,884,772	A	*	3/1999	Floyd et al.	206/701
D447,742	S	*	9/2001	Cornille	D14/218
D504,872	S	*	5/2005	Uehara et al.	D13/168
D556,154	S	*	11/2007	Poulet et al.	D13/168
D641,717	S	*	7/2011	Nan	D13/168
8,400,065	B2	*	3/2013	Malo et al.	315/149

* cited by examiner

Primary Examiner — Selina Sikder

(74) *Attorney, Agent, or Firm* — Brett Lovejoy; Morgan,
Lewis & Bockius LLP

(57) **CLAIM**

The ornamental design for a control unit casing, as shown and
described.

DESCRIPTION

FIG. 1 is a front-top perspective view of a control unit casing
according to an embodiment of the present disclosure;
FIG. 2 is a top view thereof;
FIG. 3 is a bottom view thereof;
FIG. 4 is a first side view thereof;
FIG. 5 is a second side view thereof;
FIG. 6 is a third side view thereof; and,
FIG. 7 is a fourth side view thereof.

1 Claim, 7 Drawing Sheets

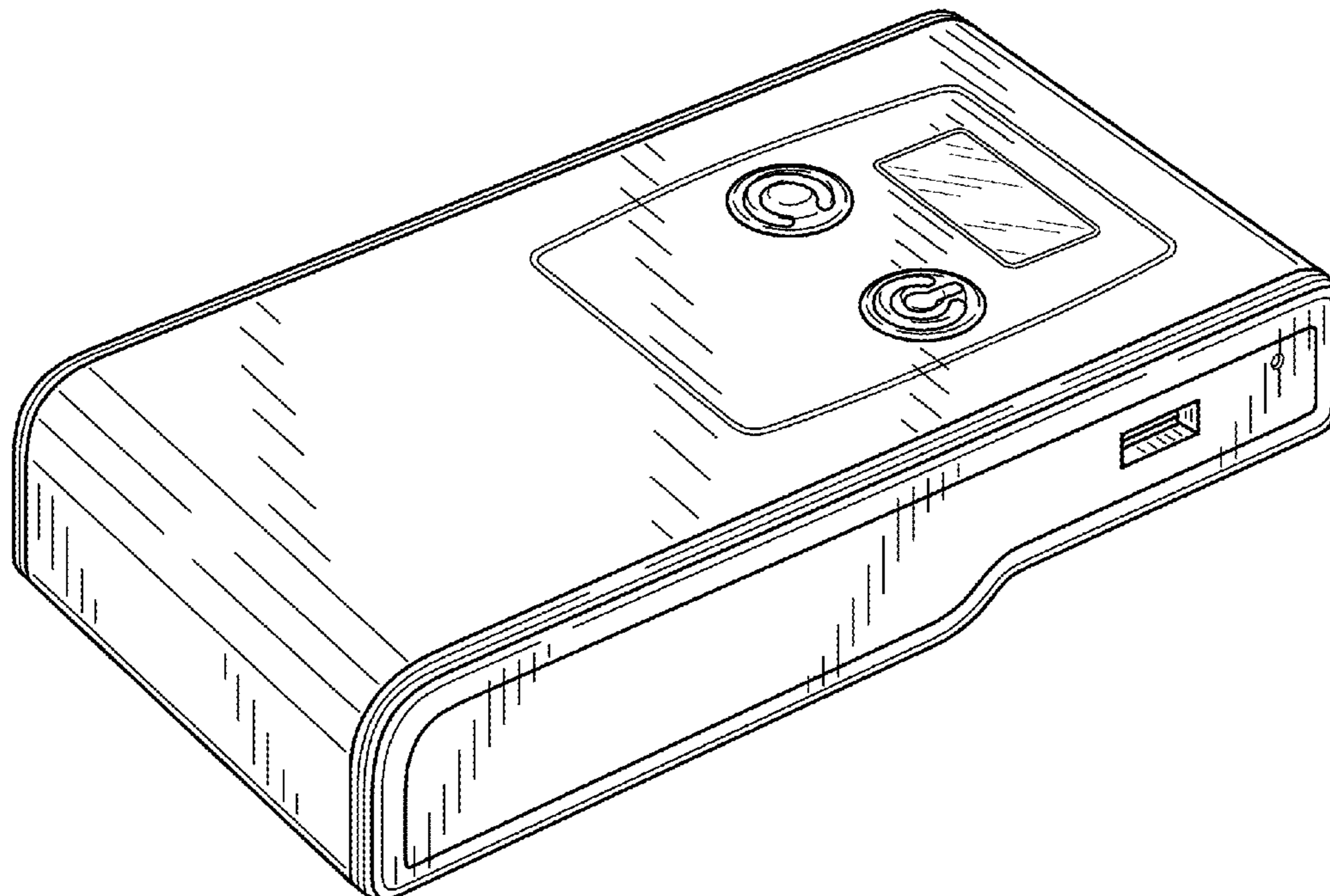

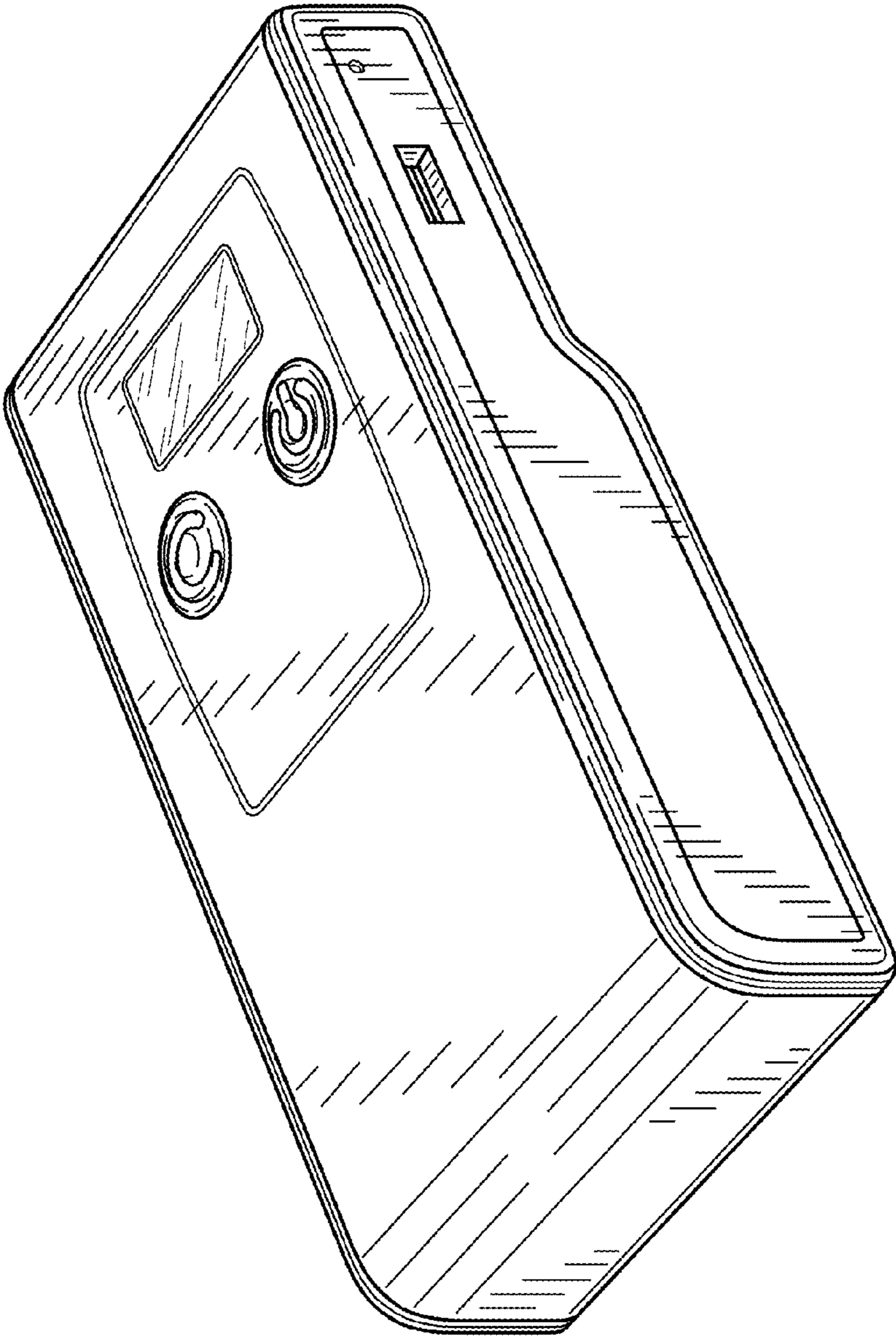

FIG. 1

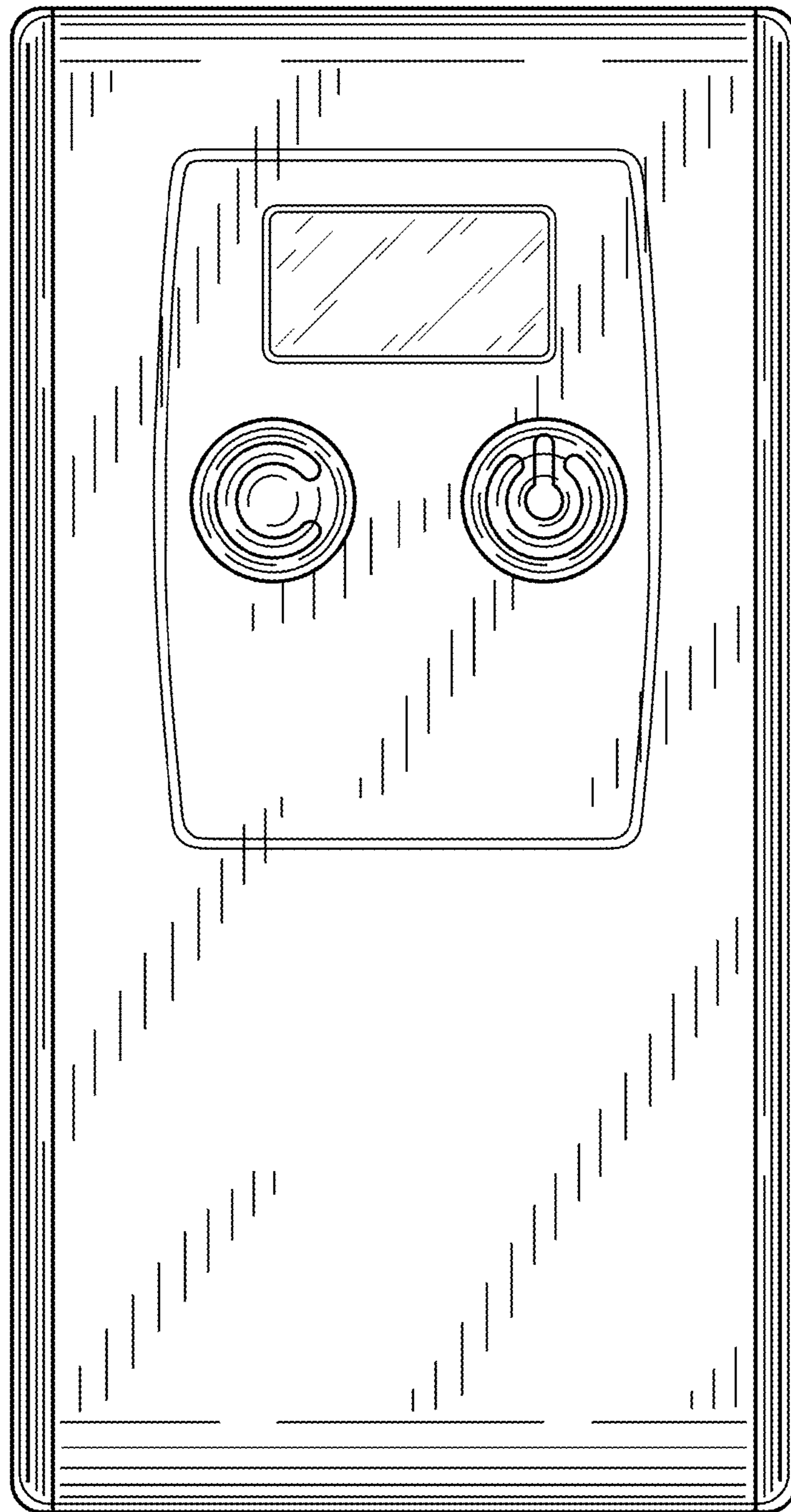

FIG. 2

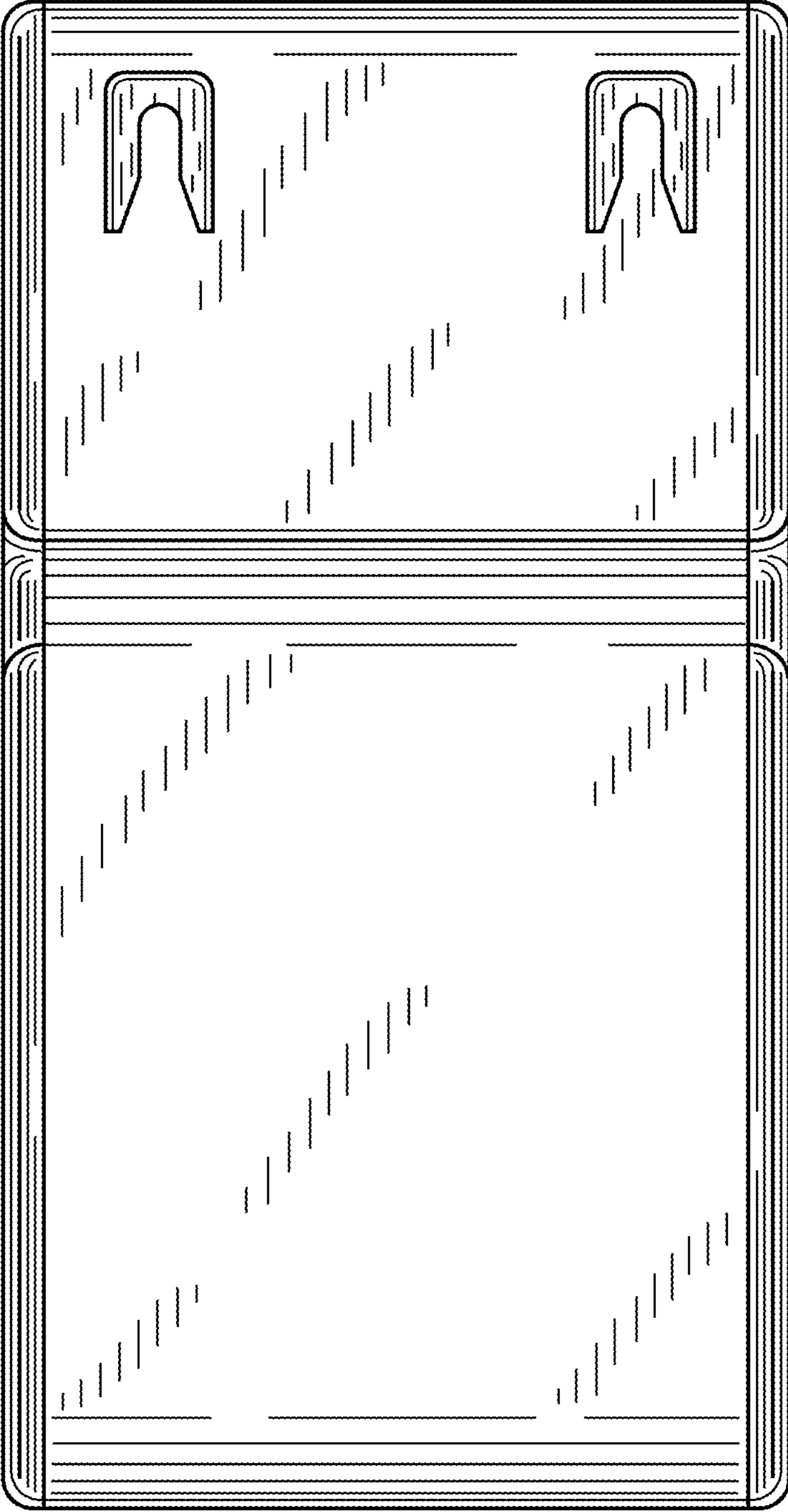

FIG. 3

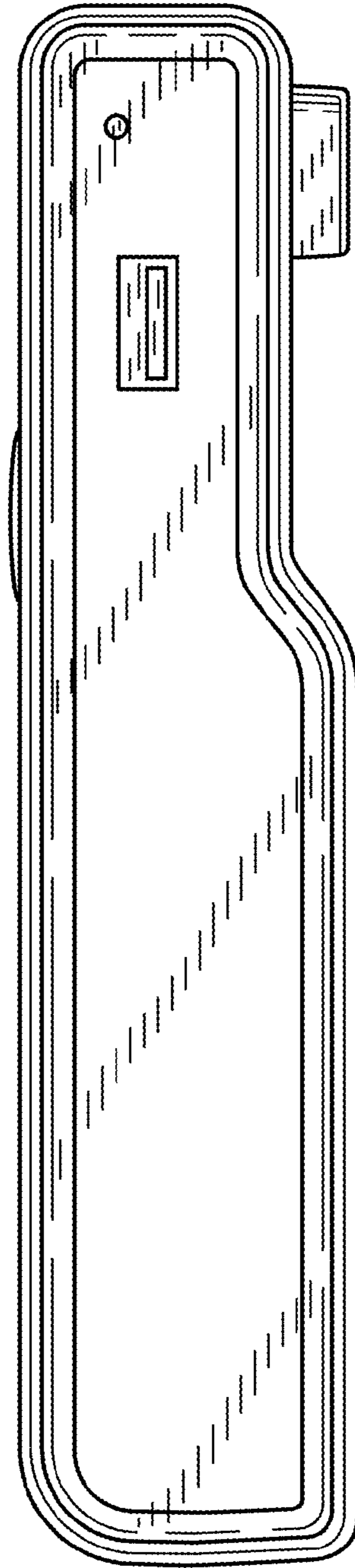

FIG. 4

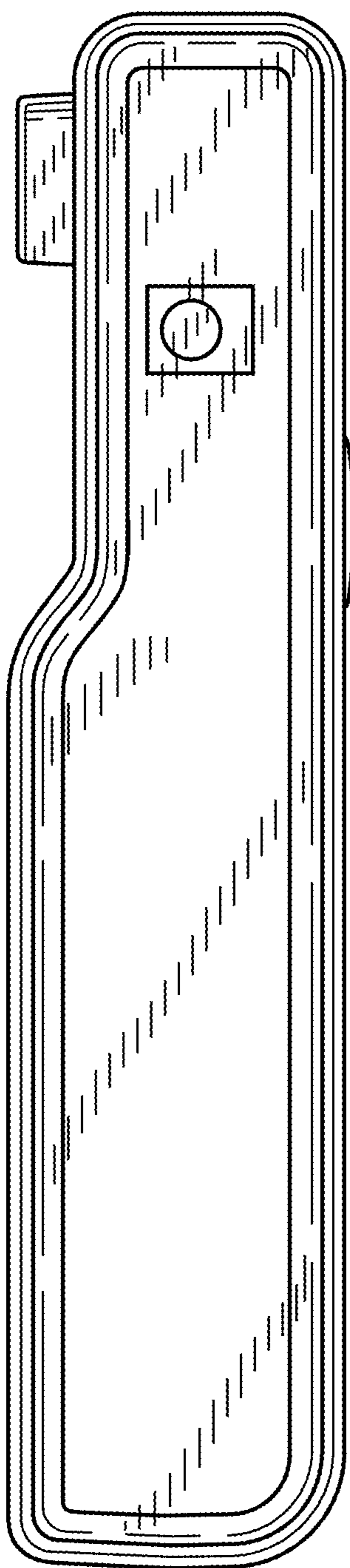

FIG. 5

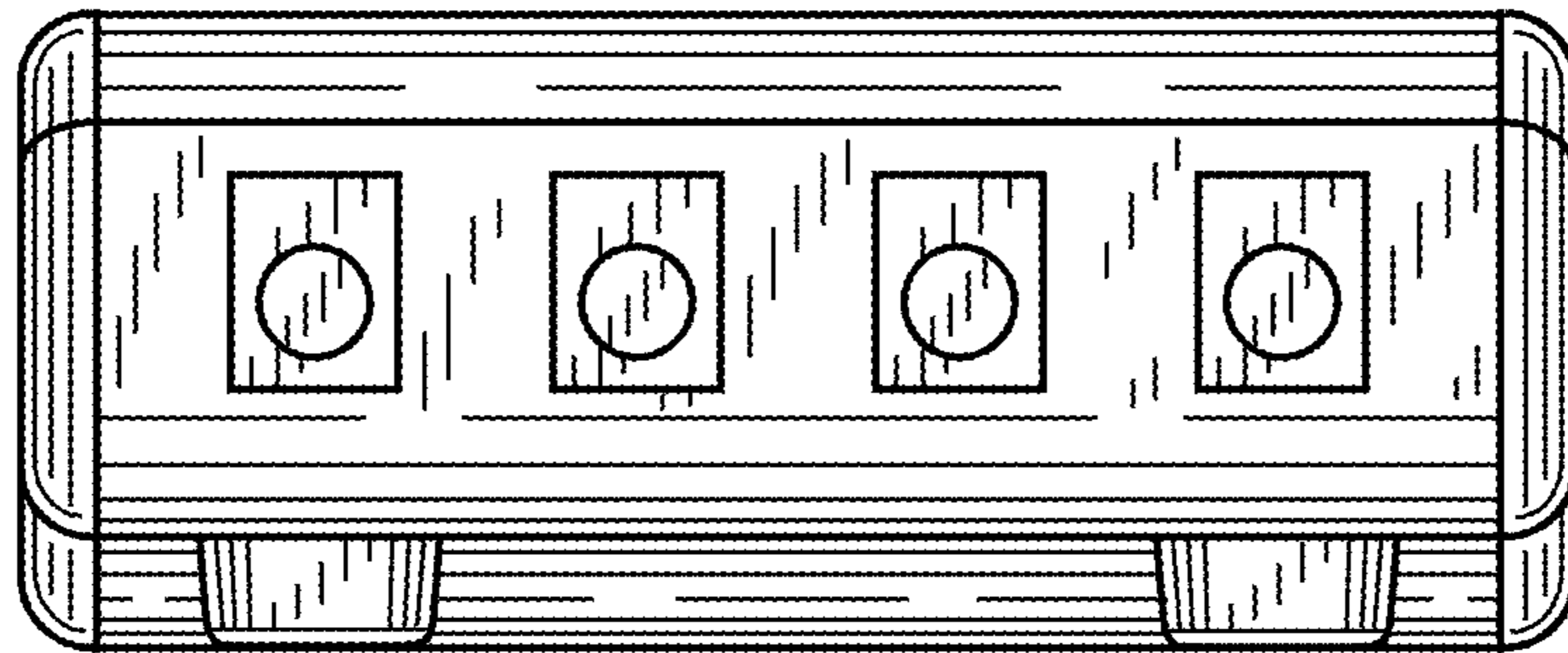

FIG. 6

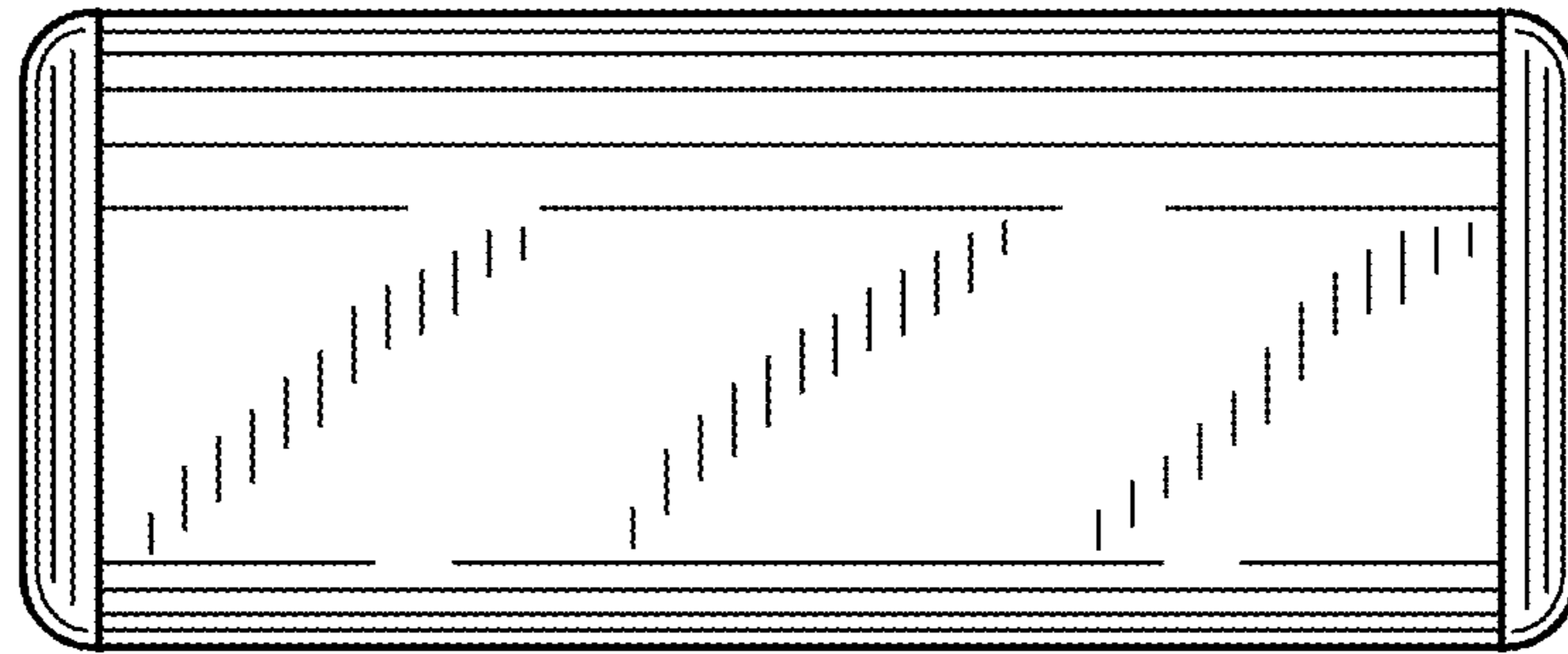

FIG. 7