

US00D691929S

(12) **United States Design Patent**
Betancourt et al.

(10) **Patent No.:** **US D691,929 S**
(45) **Date of Patent:** **** Oct. 22, 2013**

(54) **VEHICLE FRONT UPPER GRILLE**

(75) Inventors: **Melvin Betancourt**, Shelby Township, MI (US); **Mark Conforzi**, Bloomfield Hills, MI (US)

(73) Assignee: **Ford Motor Company**, Dearborn, MI (US)

(**) Term: **14 Years**

(21) Appl. No.: **29/416,134**

(22) Filed: **Mar. 19, 2012**

(51) **LOC (9) Cl.** **12-16**

(52) **U.S. Cl.**
USPC **D12/163**

(58) **Field of Classification Search**
USPC D12/163, 196, 171, 169, 216, 90-92,
D12/86; 180/68.1, 68.6; 296/193.11
See application file for complete search history.

(56) **References Cited**

U.S. PATENT DOCUMENTS

D535,221 S	1/2007	Lau et al.	
D535,589 S	1/2007	Lau et al.	
D584,996 S	1/2009	Jamieson et al.	
D604,210 S	* 11/2009	Kim	D12/163
D609,140 S	* 2/2010	Iwasaki	D12/163

D610,495 S	2/2010	Bucher et al.	
D614,087 S	* 4/2010	Ectors et al.	D12/163
D630,138 S	1/2011	Bucher et al.	
D644,964 S	* 9/2011	Tonello	D12/163
D670,213 S	* 11/2012	Koehl et al.	D12/163

* cited by examiner

Primary Examiner — Melody Brown

(74) *Attorney, Agent, or Firm* — Damian Porcari

(57) **CLAIM**

The ornamental design for a vehicle front upper grille, as shown and described.

DESCRIPTION

FIG. 1 is a top plan view of a vehicle front upper grille; FIG. 2 is a bottom plan view of the vehicle front upper grille; FIG. 3 is a front elevational view of the vehicle front upper grille; FIG. 4 is a left side elevational view of the vehicle front upper grille; FIG. 5 is a right side elevational view of the vehicle front upper grille; FIG. 6 is a perspective view of the vehicle front upper grille; and, FIG. 7 is another perspective view of the vehicle front upper grille.

1 Claim, 7 Drawing Sheets

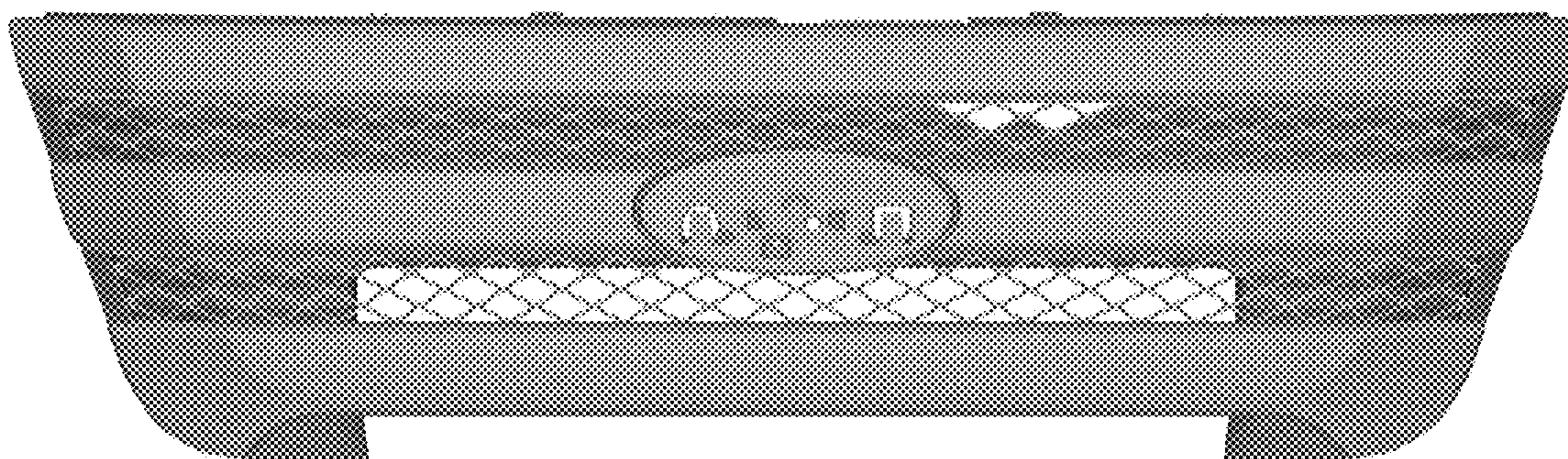

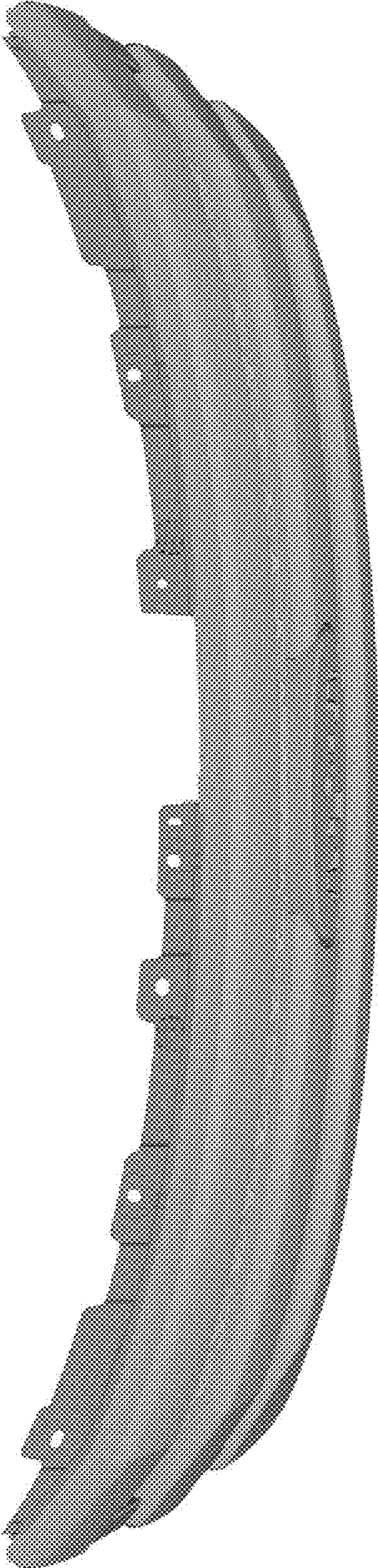
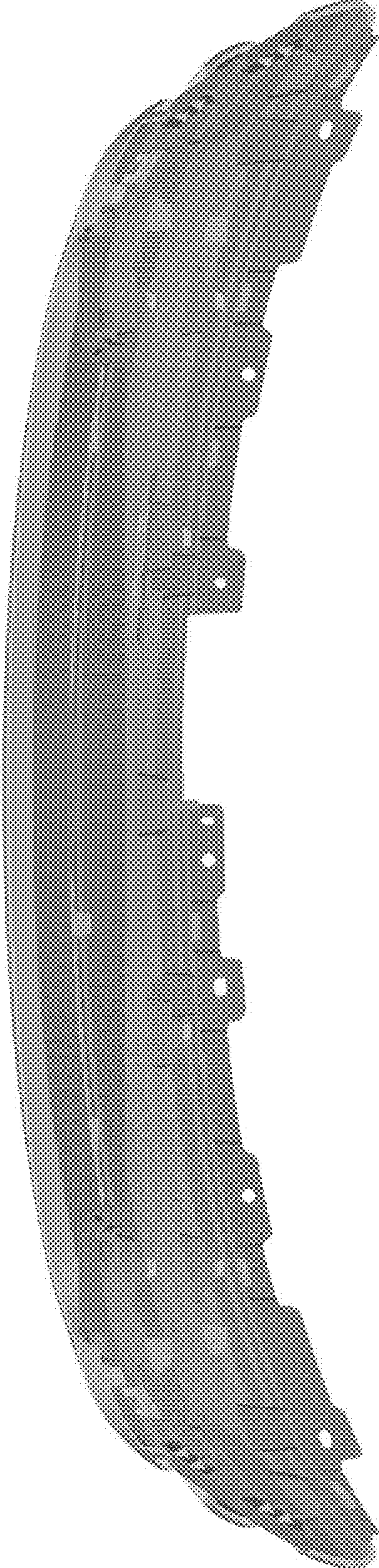

Figure 1

Figure 2



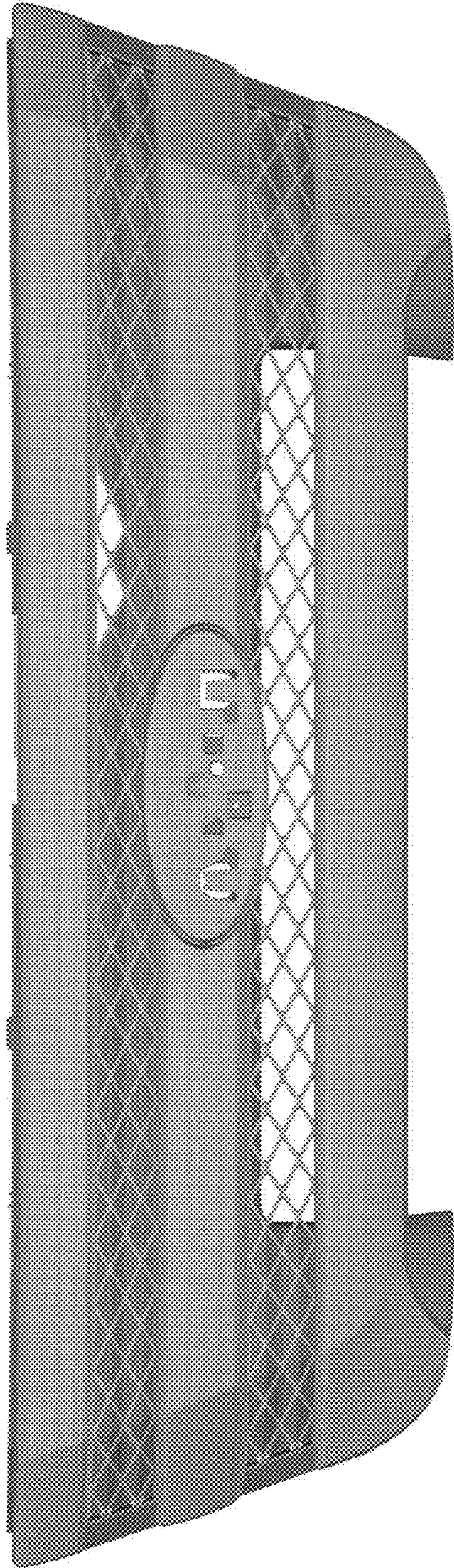

Figure 3

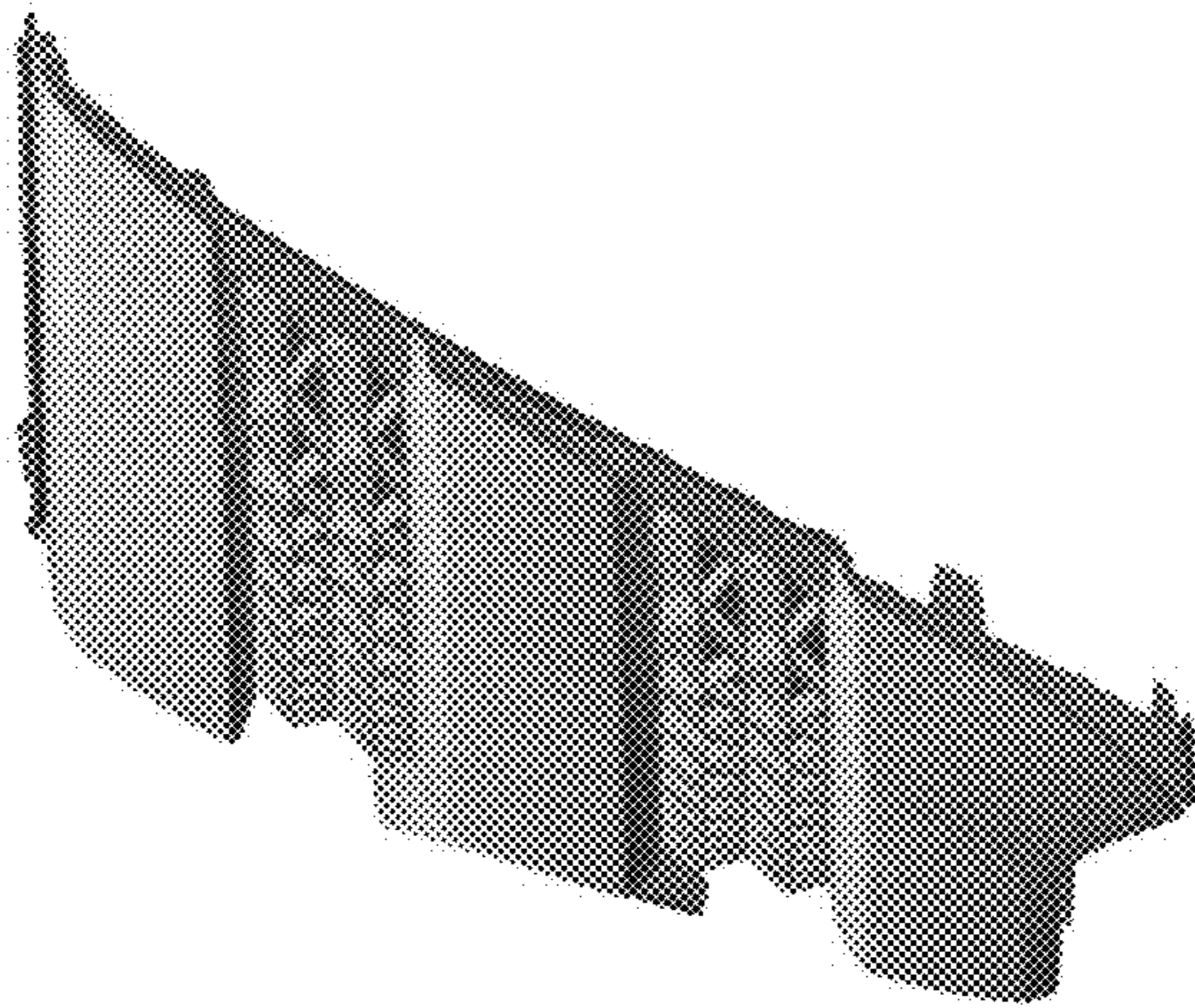

Figure 4

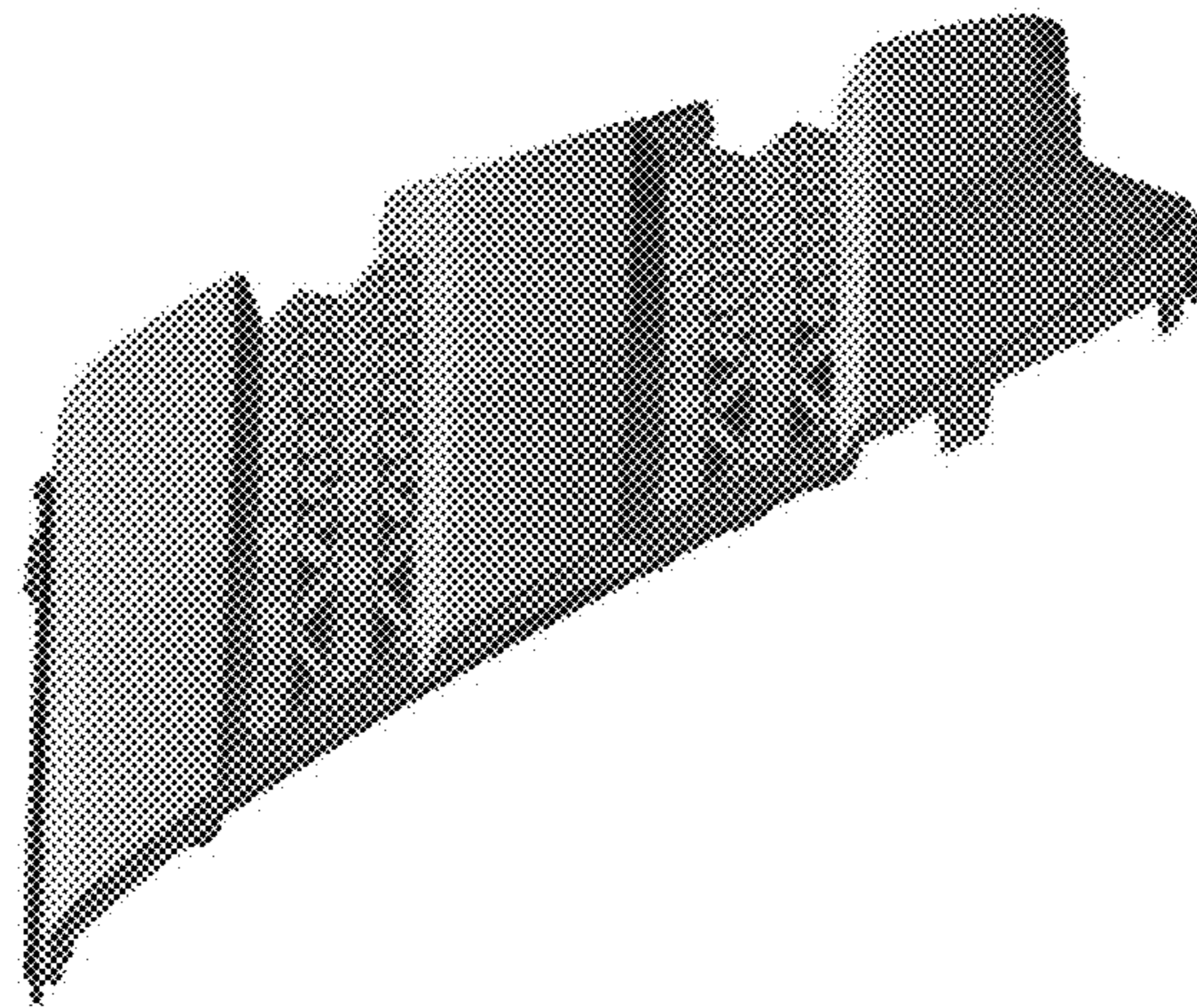

Figure 5

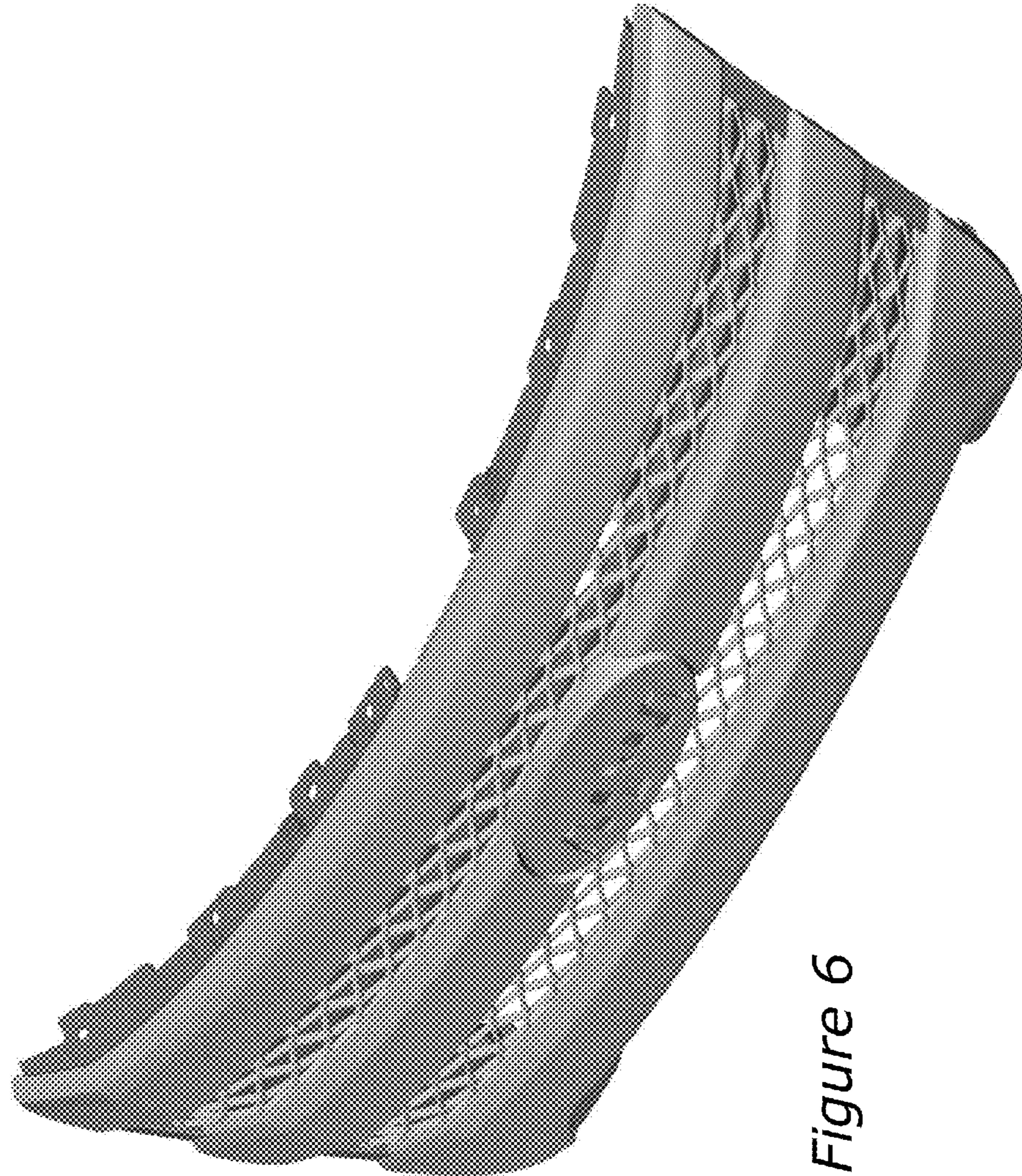

Figure 6

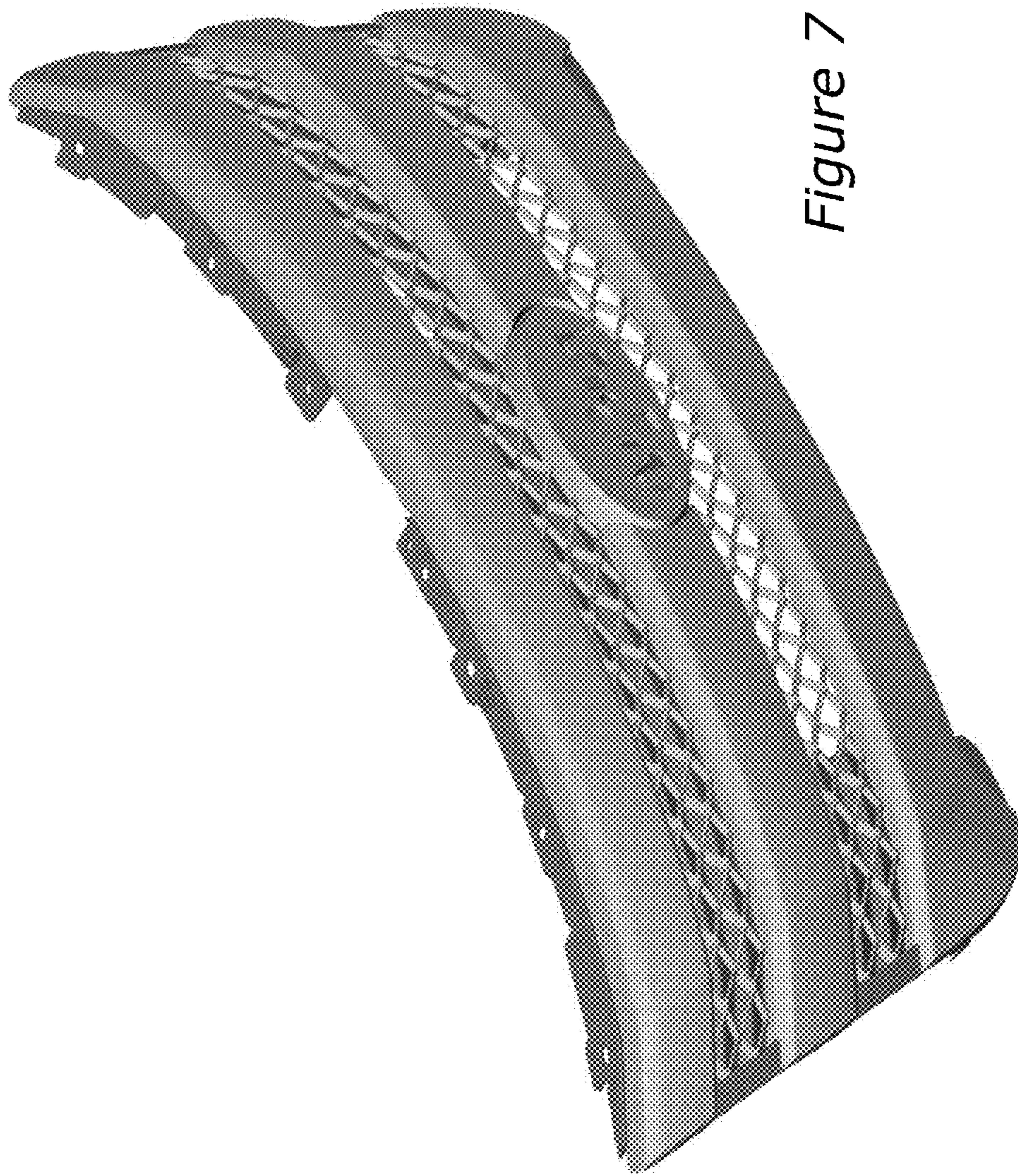

Figure 7