



US00D691917S

(12) **United States Design Patent**
DuBow

(10) **Patent No.:** **US D691,917 S**

(45) **Date of Patent:** **** Oct. 22, 2013**

(54) **REINDEER CORK CAGE ORNAMENT**

(75) Inventor: **Ardeen DuBow**, Santa Ana, CA (US)

(73) Assignee: **Epic Products, Inc.**, Santa Ana, CA (US)

(**) Term: **14 Years**

(21) Appl. No.: **29/405,352**

(22) Filed: **Nov. 1, 2011**

(51) **LOC (9) Cl.** **11-05**

(52) **U.S. Cl.**
USPC **D11/127**

(58) **Field of Classification Search**
USPC D11/117, 121, 125, 127, 131, 132, 133, D11/134, 157, 158, 159; D21/614; 428/7, 8, 428/9, 12; D3/270, 271.1, 271.2; D9/600, D9/612; D7/560, 563, 564, 571, 604, 628, D7/601, 606, 625
See application file for complete search history.

(56) **References Cited**

U.S. PATENT DOCUMENTS

D158,642 S *	5/1950	Braunberger	D11/158
D163,765 S *	6/1951	Pinterally	D21/614
D181,263 S *	10/1957	Abramson	D11/127
4,650,701 A *	3/1987	Jackson	428/16
D299,695 S *	2/1989	Hine	D9/607
5,255,461 A *	10/1993	Chiou	40/415
5,451,436 A *	9/1995	Shelleman	428/8
D368,866 S *	4/1996	Smith	D10/59
D370,643 S *	6/1996	Kapp	D11/127
D381,929 S *	8/1997	Lal et al.	D11/127
D383,416 S *	9/1997	Lal et al.	D11/127
D392,208 S *	3/1998	Chong	D11/127
5,850,927 A *	12/1998	Pan	211/181.1
D406,788 S *	3/1999	Adams et al.	D11/127

D435,327 S *	12/2000	Schallip	D1/110
D455,673 S *	4/2002	Syme	D11/127
6,413,594 B1 *	7/2002	Onishi	428/7
D482,146 S *	11/2003	Wrob	D26/25
D503,904 S *	4/2005	Morford et al.	D11/127
7,048,404 B2 *	5/2006	Pan	362/108
7,086,757 B2 *	8/2006	Wang	362/249.01
7,334,912 B1 *	2/2008	Chung	362/124
7,661,847 B2 *	2/2010	Wang	362/249.16
7,682,060 B2 *	3/2010	Wang	362/565
D620,836 S *	8/2010	Chen et al.	D11/127
D623,084 S *	9/2010	Chen et al.	D11/127
7,980,744 B2 *	7/2011	Wang	362/565
8,262,243 B1 *	9/2012	Pasdar	362/124
D682,148 S *	5/2013	DuBow	D11/157
D682,734 S *	5/2013	Dubow	D11/157

* cited by examiner

Primary Examiner — Elizabeth J Oswecki

(74) *Attorney, Agent, or Firm* — Nath, Goldberg & Meyer; Jerald L. Meyer; Scott C. Langford

(57) **CLAIM**

The ornamental design for a reindeer cork cage ornament, as shown and described.

DESCRIPTION

FIG. 1 is a perspective view of a reindeer cork cage ornament showing my new design; FIG. 2 is a left side elevation view thereof; FIG. 3 is a right side elevation view thereof; FIG. 4 is a front elevation view thereof; FIG. 5 is a rear elevation view thereof; FIG. 6 is a top view thereof; and, FIG. 7 is a bottom view thereof. The broken lines shown in the drawings represent portions of the reindeer cork cage ornament that form no part of the claimed design.

1 Claim, 4 Drawing Sheets

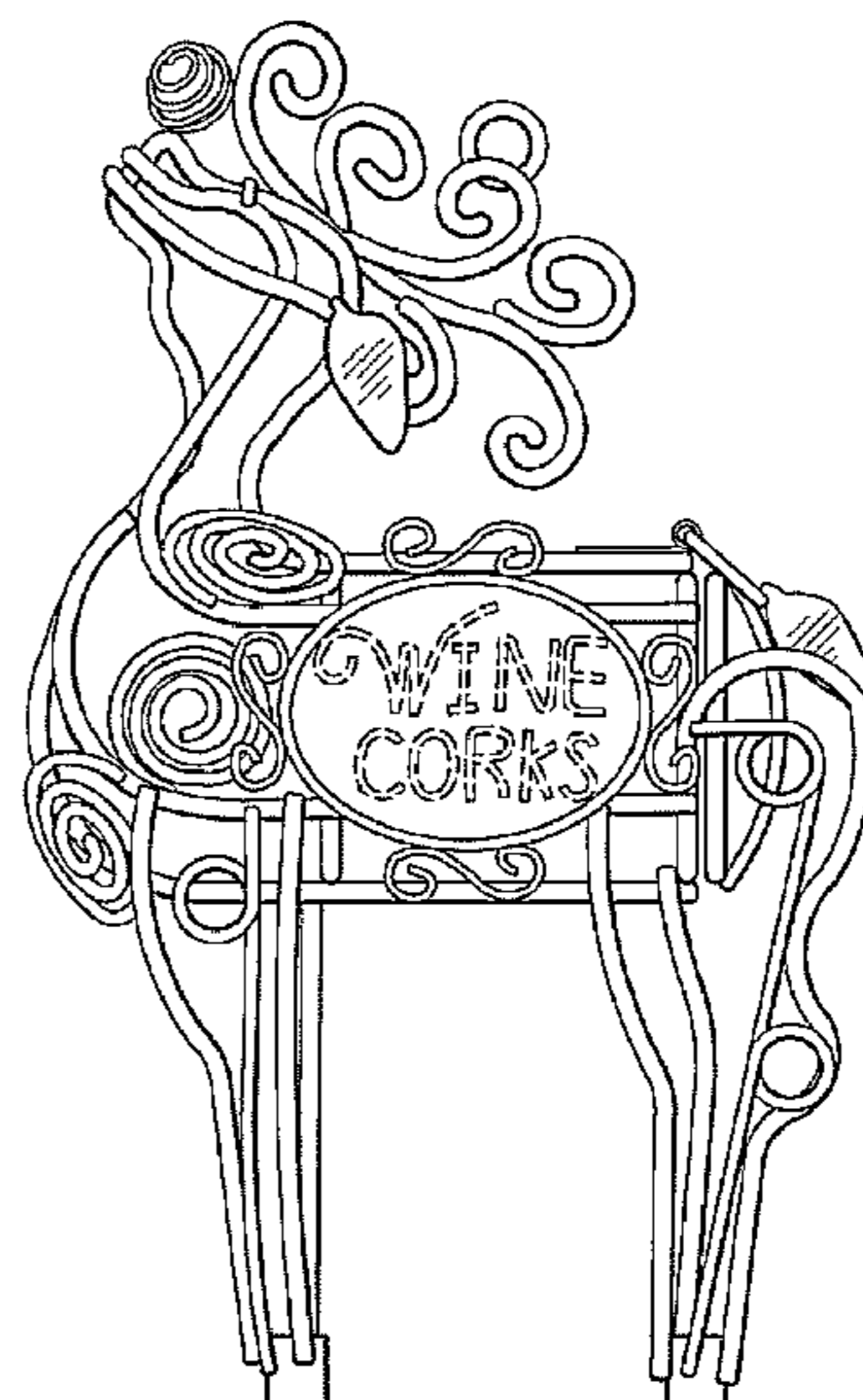
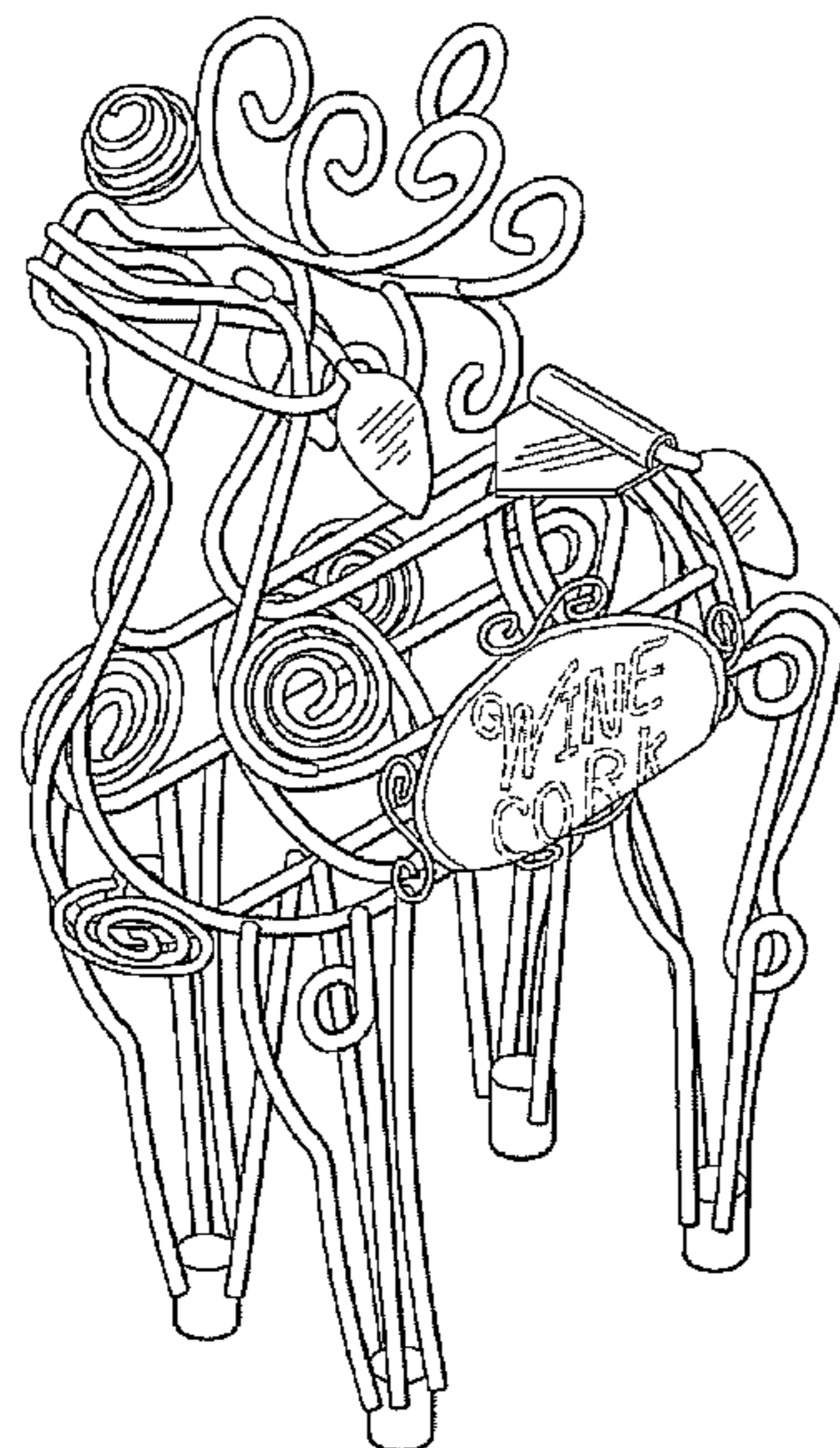

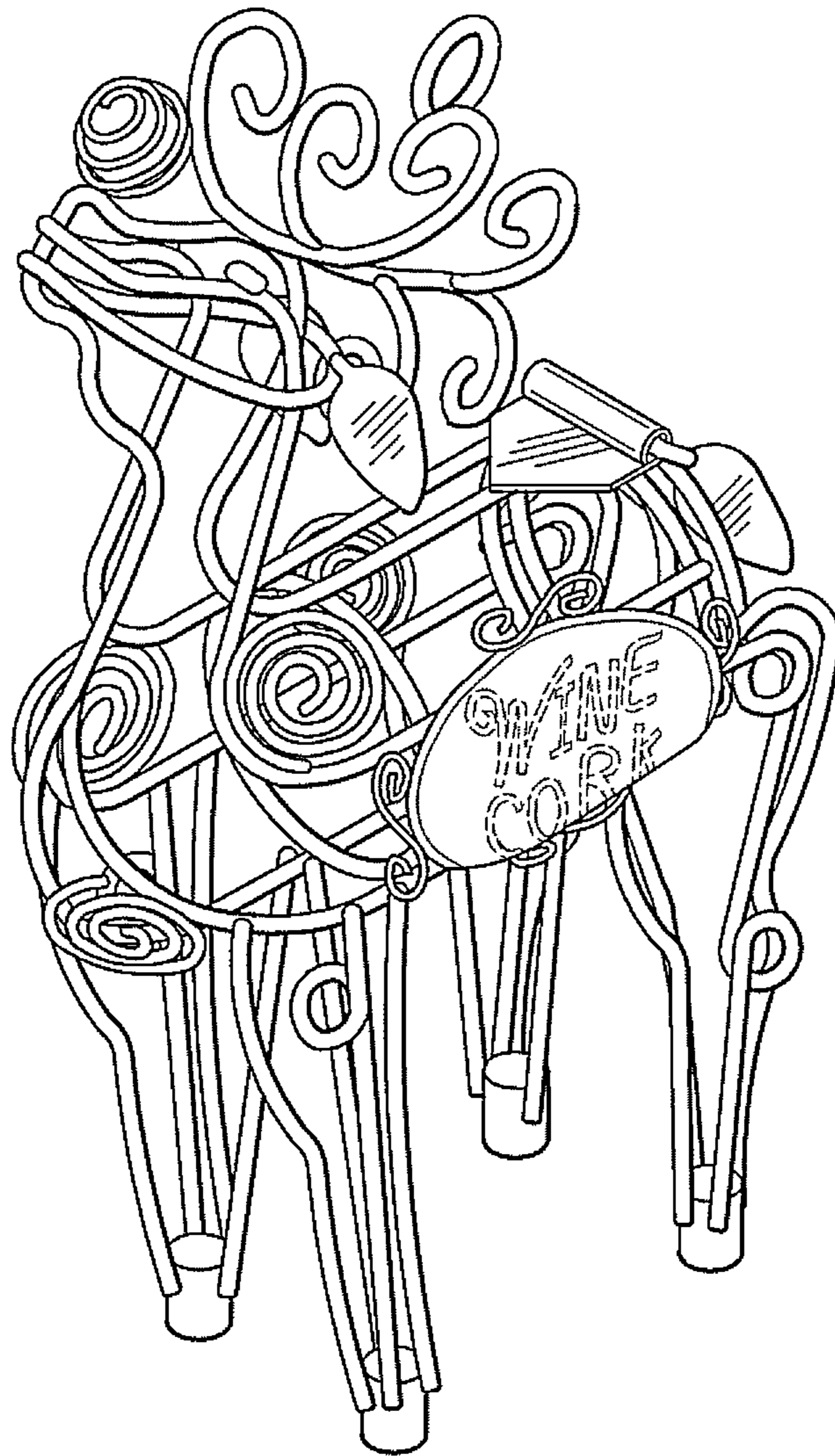

FIG. 1

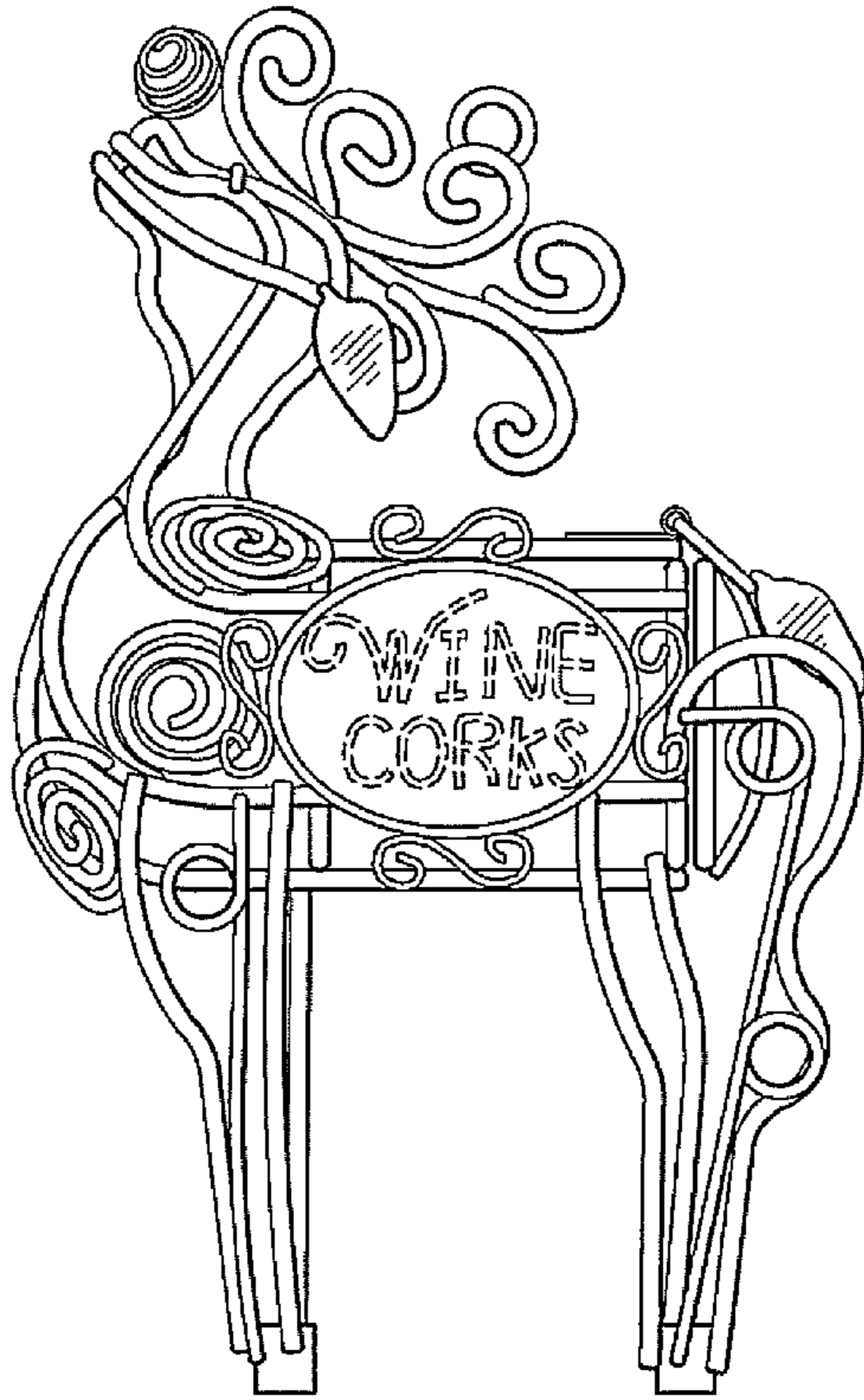

FIG. 2

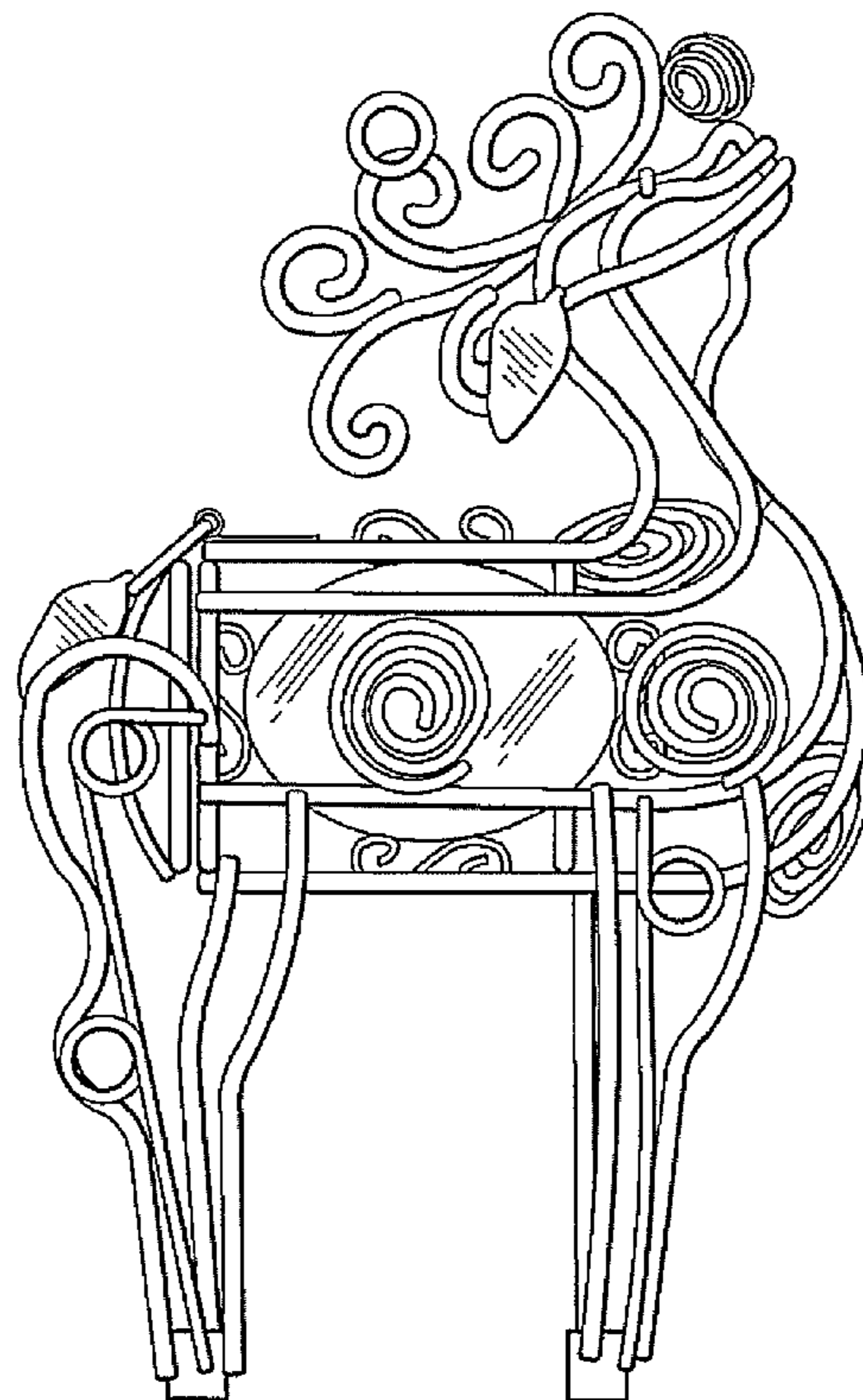

FIG. 3

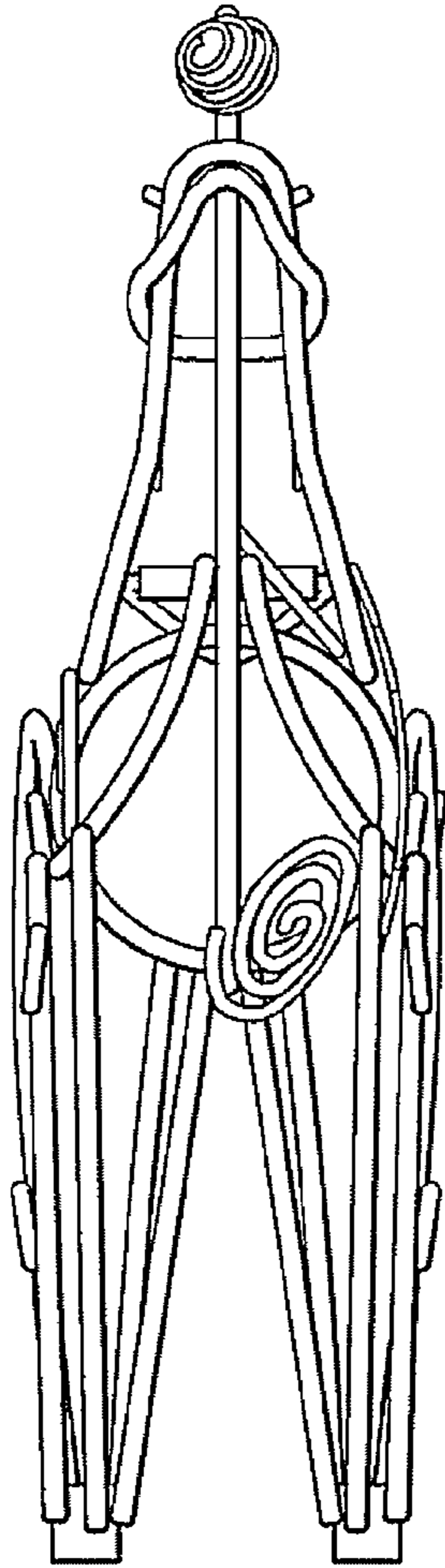

FIG. 4

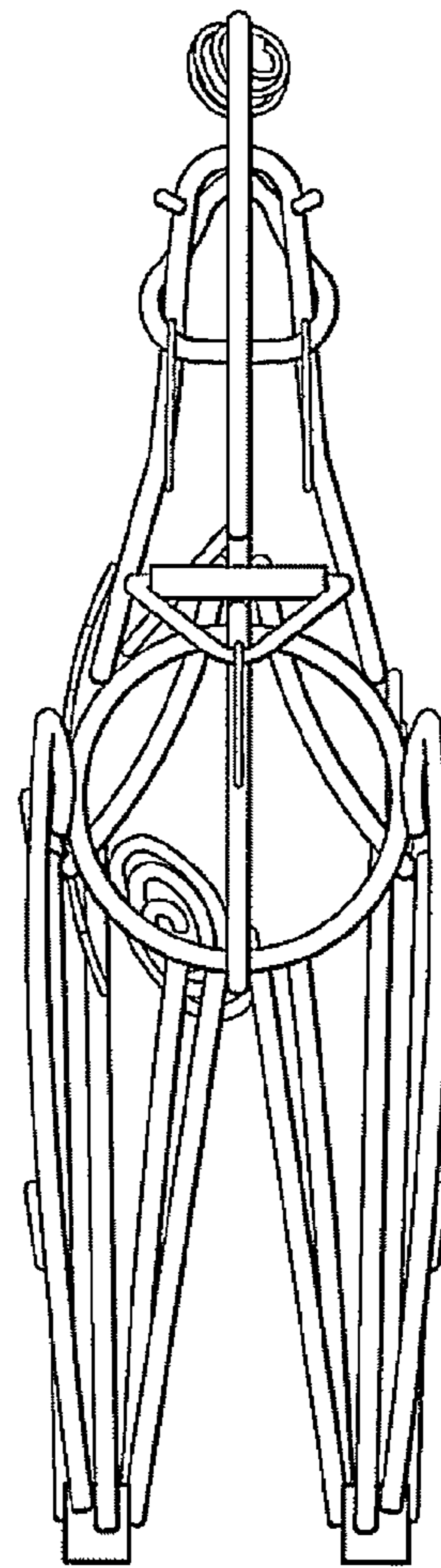

FIG. 5

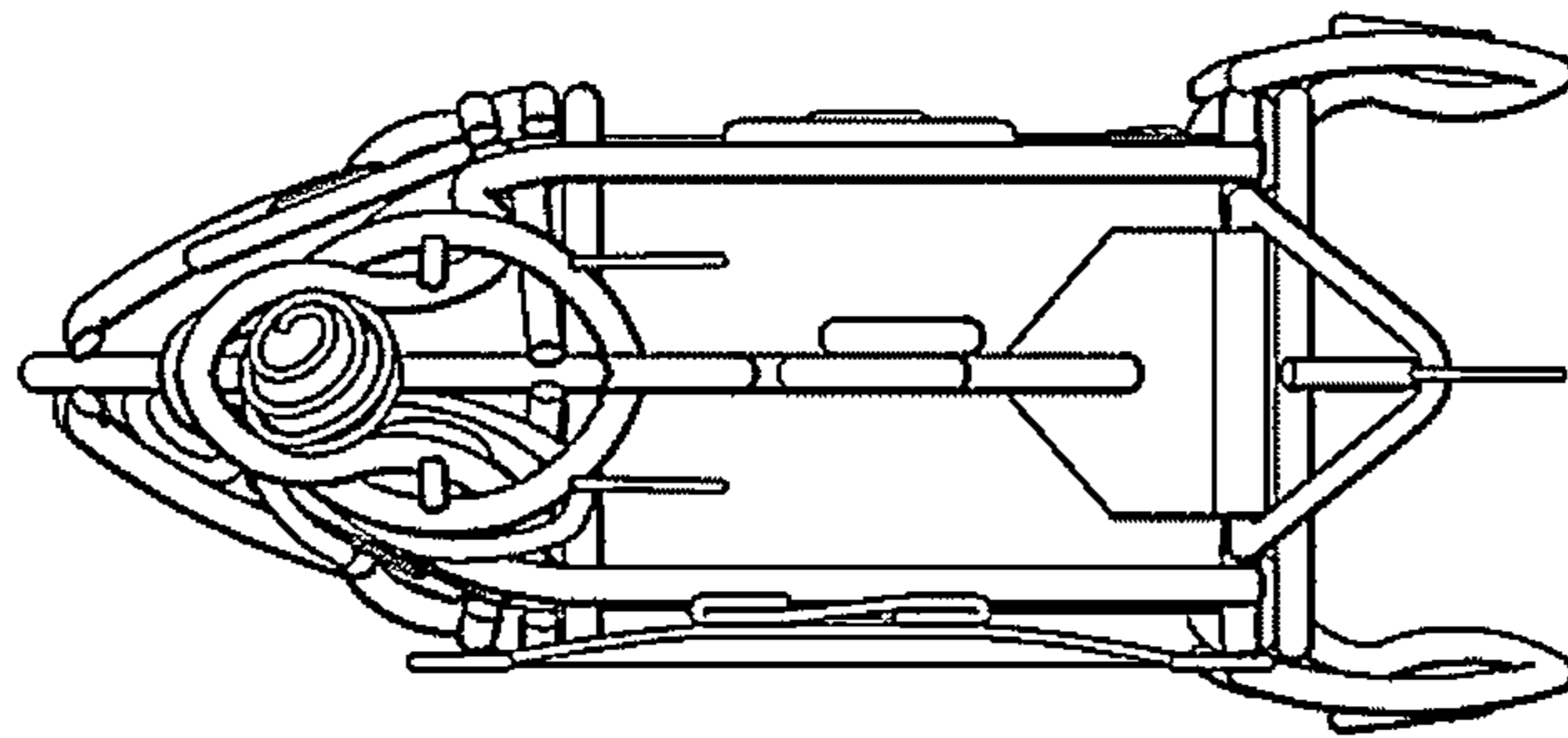

FIG. 6

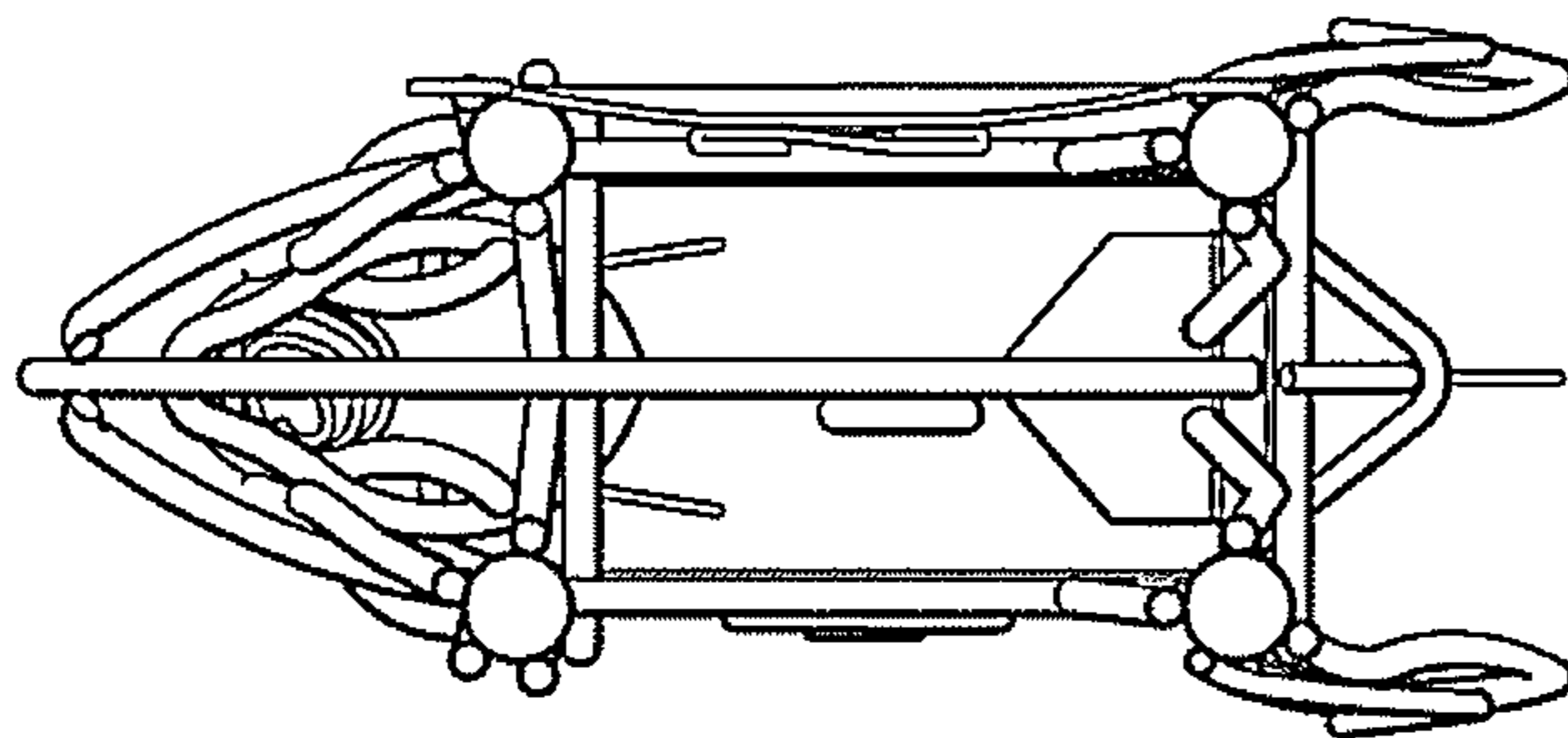

FIG. 7