



US00D691897S

(12) **United States Design Patent**  
**Jung et al.**

(10) **Patent No.:** **US D691,897 S**

(45) **Date of Patent:** **\*\* Oct. 22, 2013**

(54) **COSMETIC CONTAINER**

(75) Inventors: **Shin-Bok Jung**, Incheon (KR);  
**Sung-Woo Cheon**, Incheon (KR)

(73) Assignee: **Yonwoo Co., Ltd.**, Icheon (KR)

(\*\*) Term: **14 Years**

(21) Appl. No.: **29/419,324**

(22) Filed: **Apr. 26, 2012**

(30) **Foreign Application Priority Data**

Apr. 12, 2012 (KR) ..... 30-2012-0017100

(51) **LOC (9) Cl.** ..... **09-01**

(52) **U.S. Cl.**  
USPC ..... **D9/690**

(58) **Field of Classification Search**

USPC ..... D9/682-695, 697-699, 715, 723-726,  
D9/500-505, 516, 521, 526, 529, 549-575,  
D9/434-436, 442, 445, 447-450; 222/92,  
222/95, 96, 106, 107, 129, 135, 153.01,  
222/153.03, 153.04, 153.09,  
222/153.11-153.14, 182, 631, 635, 209,  
222/211-213, 215, 321.7-321.9, 372, 373,  
222/378, 379, 383.1, 384-386, 398, 400.7,  
222/400.8, 401, 402.1-402.25; D28/76, 77,  
D28/82, 91, 91.1; 132/286, 293, 394, 298,  
132/299, 317

See application file for complete search history.

(56) **References Cited**

U.S. PATENT DOCUMENTS

D187,162 S \* 2/1960 Lerner et al. .... D9/905  
D216,950 S \* 3/1970 Beck ..... D9/448  
D274,848 S \* 7/1984 Chevassus ..... D28/76  
4,913,322 A \* 4/1990 Stoffler et al. .... 222/207  
5,454,488 A \* 10/1995 Geier ..... 222/95

D403,589 S \* 1/1999 Wong ..... D9/529  
D446,456 S \* 8/2001 Adachi et al. .... D9/529  
D522,378 S \* 6/2006 Honda ..... D9/689  
D547,661 S \* 7/2007 Blasko et al. .... D9/529  
D554,525 S \* 11/2007 Py et al. .... D9/688  
D577,998 S \* 10/2008 Decottignies ..... D9/448  
D582,283 S \* 12/2008 O'Donahue ..... D9/529

(Continued)

FOREIGN PATENT DOCUMENTS

KR 300407404.0000 \* 2/2006  
KR 300424859.0001 \* 9/2006

(Continued)

*Primary Examiner* — Catherine Tuttle

(57)

**CLAIM**

The ornamental design for the cosmetic container, as shown and described.

**DESCRIPTION**

FIG. 1 is a perspective view of the cosmetic container showing our new design view;  
FIG. 2 is a front elevational view thereof;  
FIG. 3 is a rear elevational view thereof;  
FIG. 4 is a left side elevational view thereof, where the right elevational view is symmetrical with the left elevational view;  
FIG. 5 is a top plan view thereof;  
FIG. 6 is a bottom plan view thereof; and,  
FIG. 7 is a perspective view showing the design in use.

The broken lines shown in FIG. 6 are included for the purpose of illustrating a portion of the cosmetic container that forms no part of the claimed design.

The appearance within the unshaded region spanning the top surface and showing in FIGS. 1 and 5 likewise forms no part of the claimed design.

The broken and dotted lines showing a human hand and material being dispensed in FIG. 7 form no part of the claimed design, but are included for the purpose of illustrating the nature and intended use of the cosmetic container.

**1 Claim, 4 Drawing Sheets**

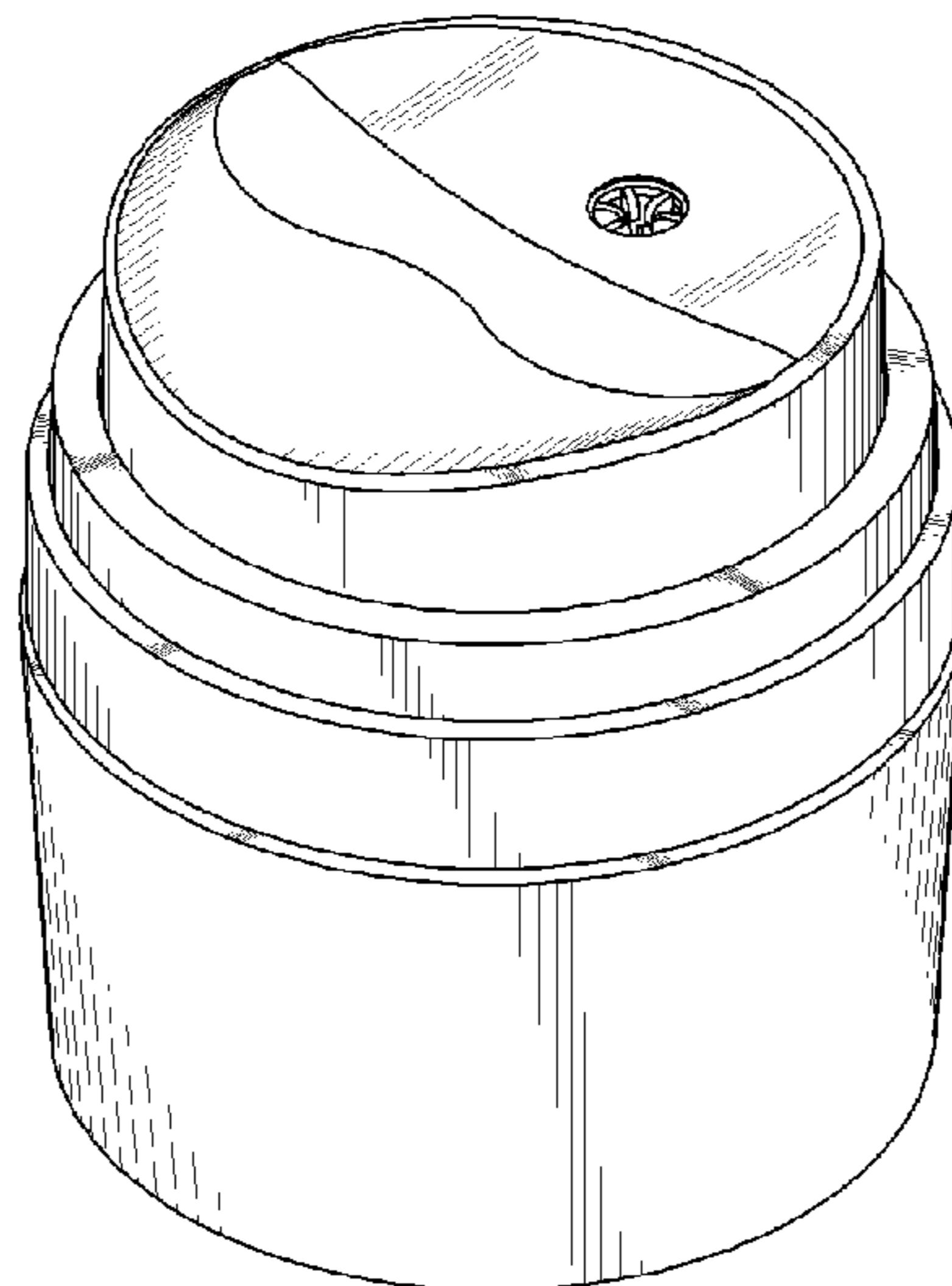

(56)

**References Cited**

FOREIGN PATENT DOCUMENTS

U.S. PATENT DOCUMENTS

D630,949 S \* 1/2011 Lim ..... D9/690  
D634,639 S \* 3/2011 L'Abbate ..... D9/529  
D657,691 S \* 4/2012 Lim ..... D9/690  
2008/0169312 A1 \* 7/2008 Kee ..... 222/205  
2009/0218008 A1 \* 9/2009 Law ..... 141/311 R  
2009/0314810 A1 \* 12/2009 Neuhaus ..... 222/402.13

KR 300433730.0000 \* 12/2006  
KR D1357544 \* 4/2009  
KR 300556554.0000 \* 3/2010  
KR 300560608.0000 \* 5/2010  
KR 300636578.0000 \* 3/2012

\* cited by examiner

Fig .1

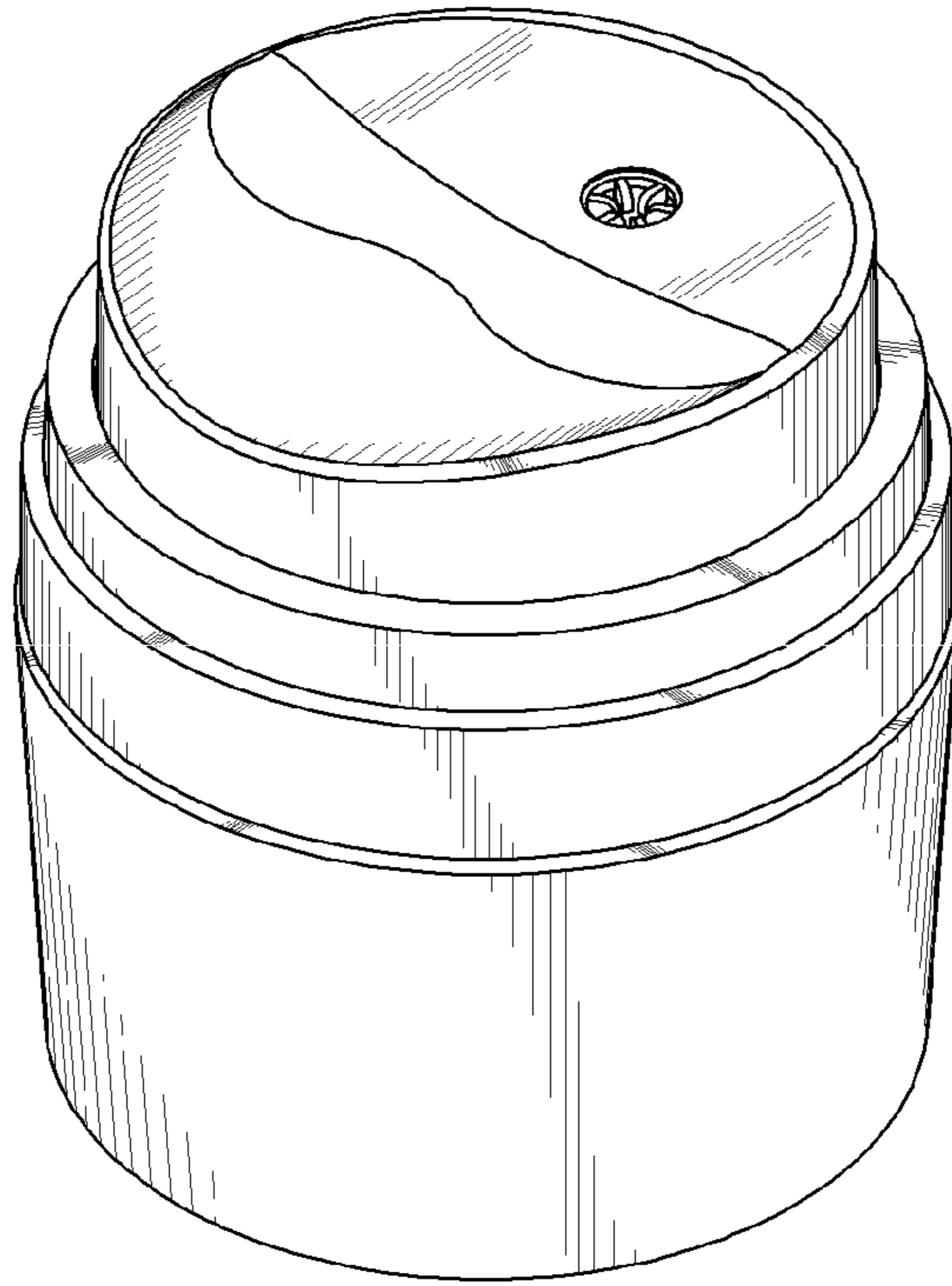

Fig.2

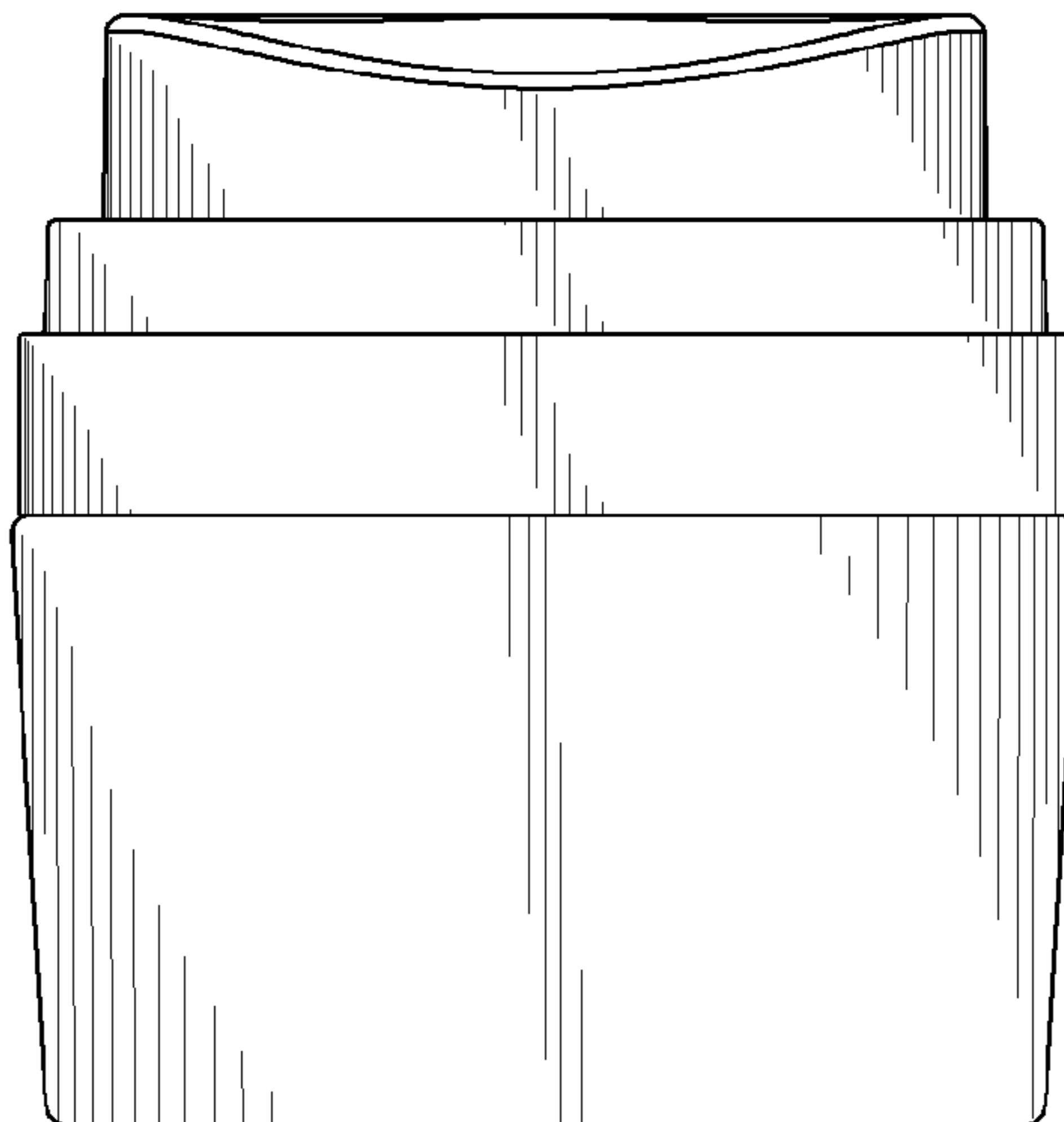

Fig. 3

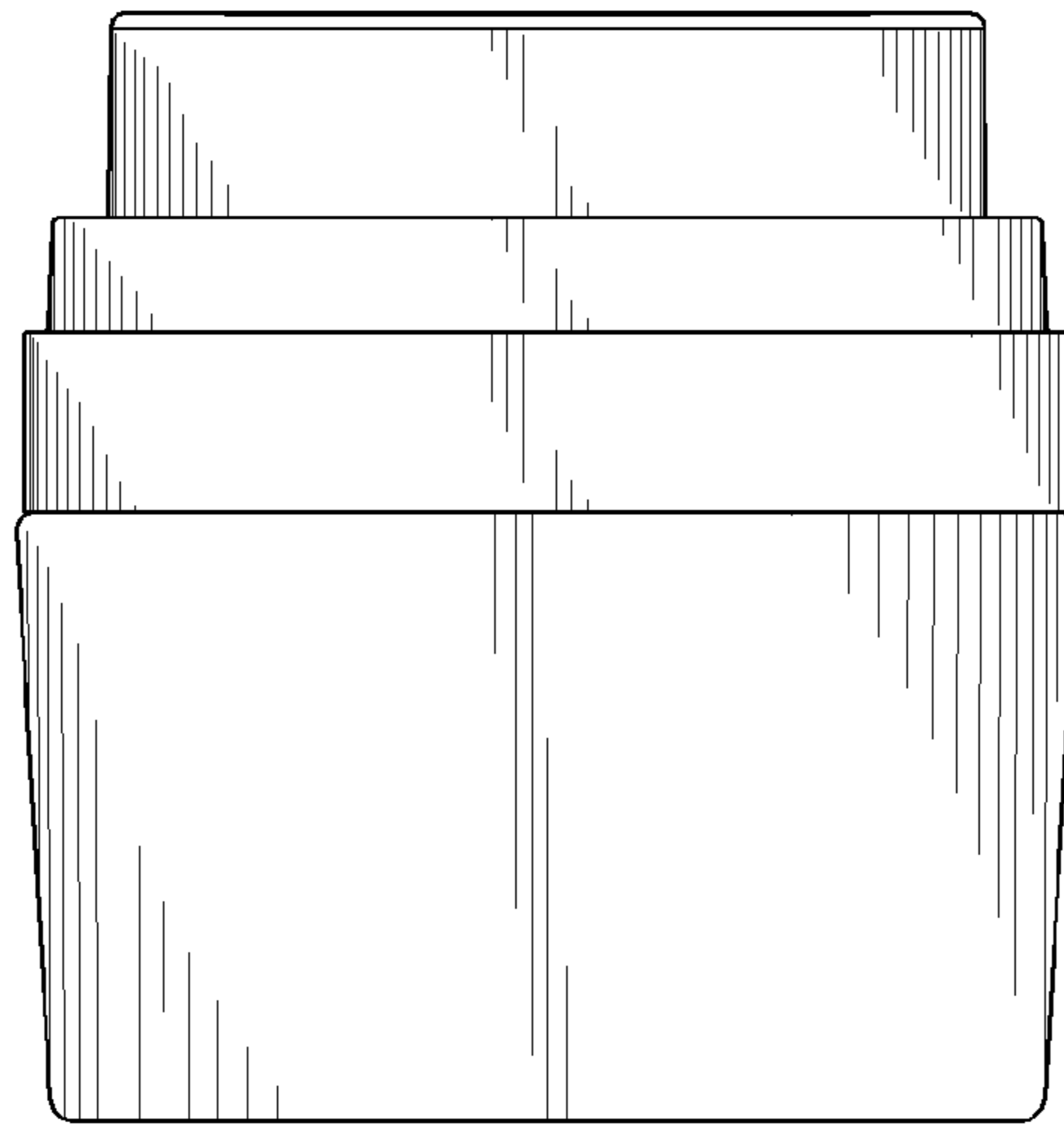

Fig. 4

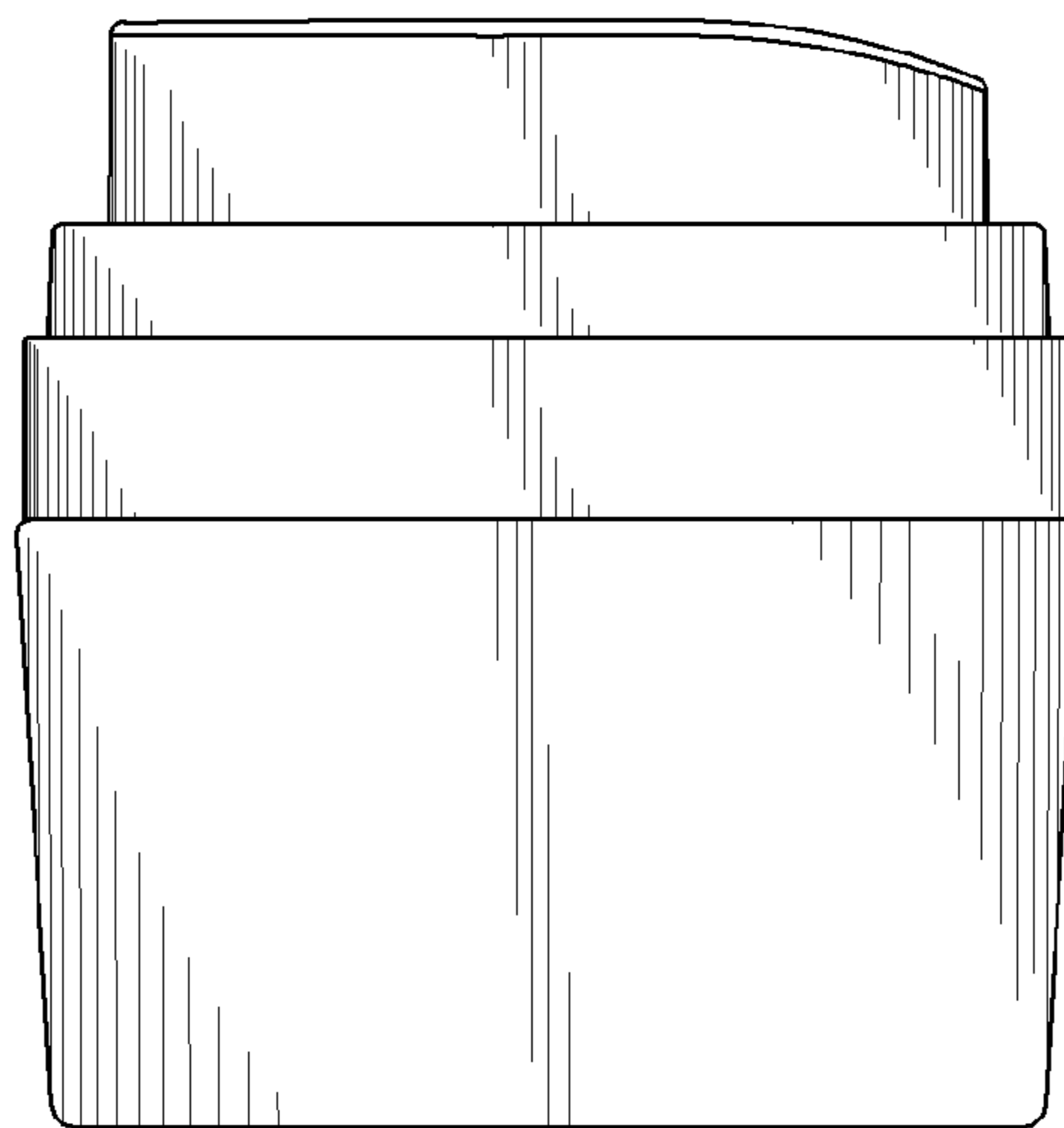

Fig .5

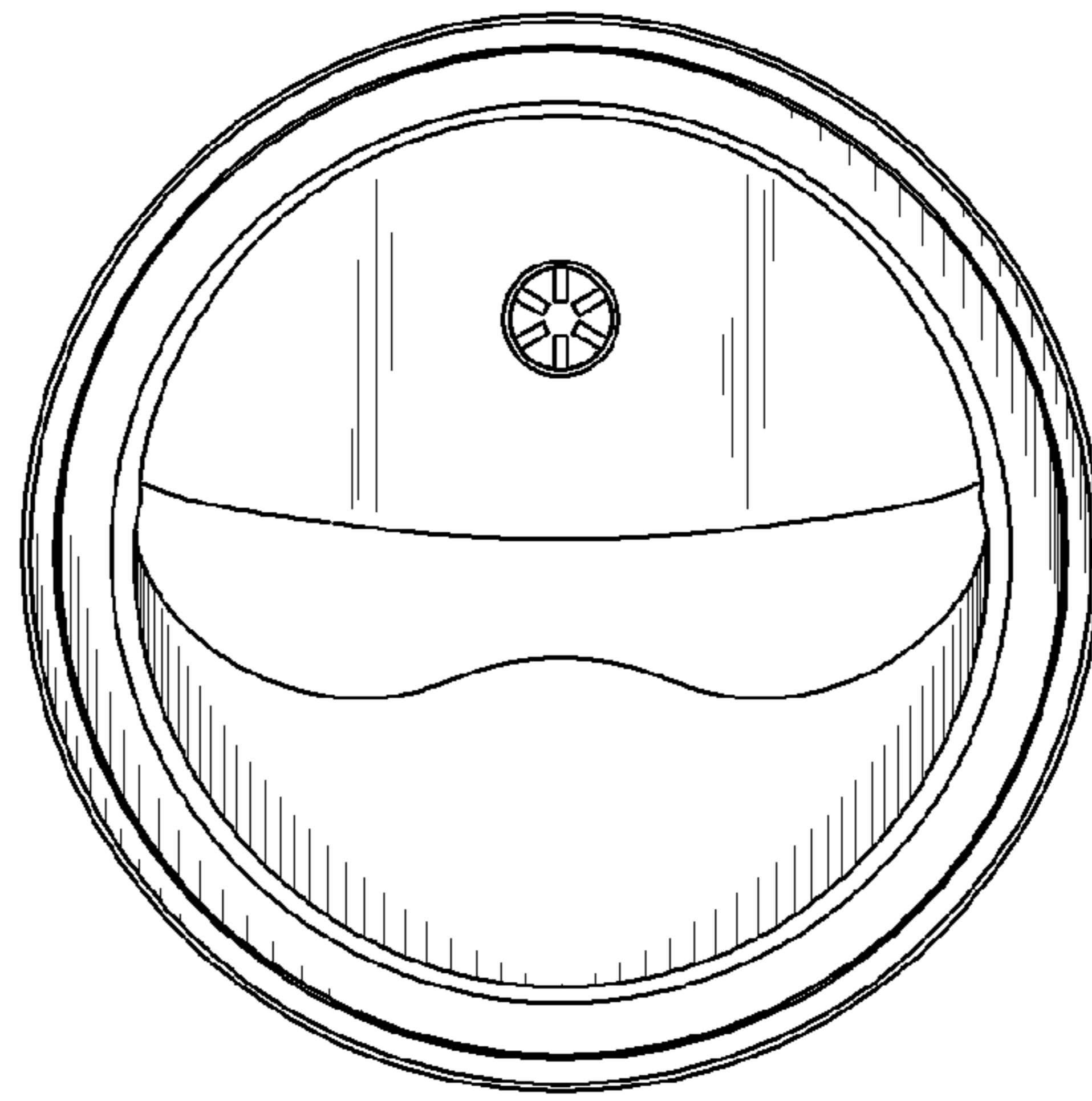

Fig .6

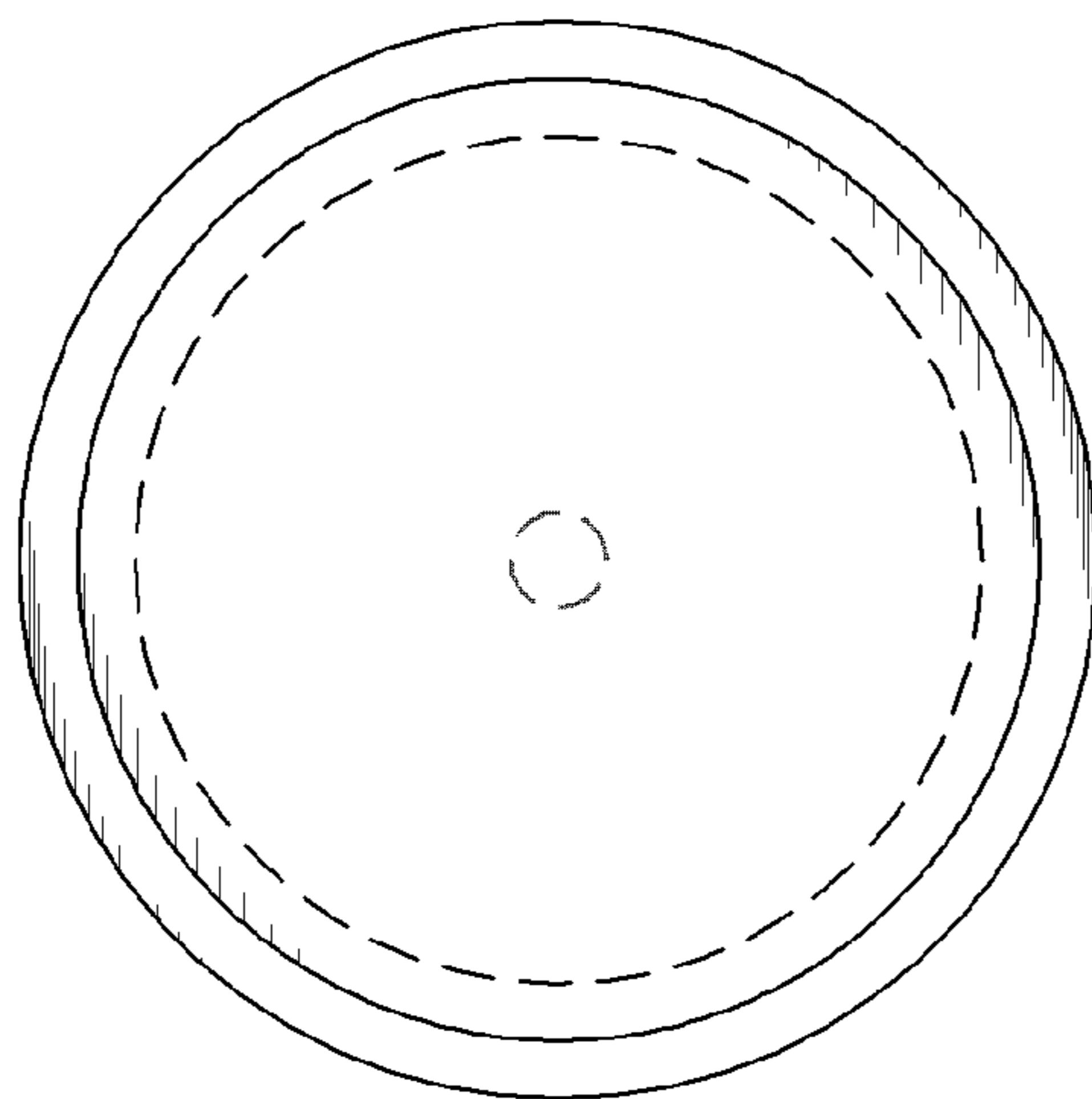

Fig .7

