



US00D691826S

(12) **United States Design Patent**  
**Banda**

(10) **Patent No.:** **US D691,826 S**  
(45) **Date of Patent:** **\*\* Oct. 22, 2013**

(54) **FURNITURE**

(71) Applicant: **Andrea Banda**, Baldwin, MS (US)

(72) Inventor: **Andrea Banda**, Baldwin, MS (US)

(73) Assignee: **H.M. Richards, Inc.**, Baldwin, MS (US)

(\*\*) Term: **14 Years**

(21) Appl. No.: **29/449,785**

(22) Filed: **Mar. 15, 2013**

(51) **LOC (9) Cl.** ..... **06-01**

(52) **U.S. Cl.**  
USPC ..... **D6/381**

(58) **Field of Classification Search**  
USPC ..... D6/334–338, 349, 355, 361, 368–370,  
D6/376, 379–381, 708, 716, 716.1;  
297/16.1, 42, 94, 135, 175, 232, 233,  
297/350, 351, 445.1, 448.1, 448.2, 451.9;  
5/12.1, 12.2

See application file for complete search history.

(56) **References Cited**

**U.S. PATENT DOCUMENTS**

D80,600 S *	3/1930	Bernhard	.....	D6/381
D103,416 S *	3/1937	Tyrrell	.....	D6/381
D234,731 S *	4/1975	McDonald	.....	D6/371
3,929,375 A *	12/1975	Gans	.....	297/440.23
D239,580 S *	4/1976	Robertson	.....	D6/381
D241,590 S *	9/1976	Kaplan	.....	D6/381
D247,595 S *	3/1978	Corson et al.	.....	D6/381
D248,997 S *	8/1978	Peed	.....	D6/381
D257,454 S *	10/1980	Nash	.....	D6/364
D352,186 S *	11/1994	Torck et al.	.....	D6/381
D381,216 S *	7/1997	Paus	.....	D6/381
D382,129 S *	8/1997	Lewis	.....	D6/381
D399,661 S *	10/1998	Smith	.....	D6/334
D415,628 S *	10/1999	Lewis	.....	D6/381
D422,159 S *	4/2000	Lewis	.....	D6/381
D423,808 S *	5/2000	Natuzzi et al.	.....	D6/381

D439,431 S *	3/2001	Binder et al.	.....	D6/381
D448,946 S *	10/2001	Goetz	.....	D6/381
D473,723 S *	4/2003	Pesso	.....	D6/334
D485,086 S *	1/2004	Gomez	.....	D6/381

(Continued)

*Primary Examiner* — Sandra Snapp

(74) *Attorney, Agent, or Firm* — Jeremy A. Smith; John W. Smith T; Bradley Arant Boult Cummings LLP

(57) **CLAIM**

The ornamental design for furniture, as shown and described.

**DESCRIPTION**

FIG. 1 shows a front view of one embodiment of the furniture. FIG. 2 shows top view of the embodiment of the furniture shown in FIG. 1.

FIG. 3 shows a front perspective view of the embodiment of the furniture shown in FIG. 1.

FIG. 4 shows an alternate front perspective view of the embodiment of the furniture shown in FIG. 1.

FIG. 5 shows a side view of an alternate embodiment of the furniture shown in FIG. 1.

FIG. 6 shows an alternate side view of the embodiment of the furniture shown in FIG. 1.

FIG. 7 shows a front view of an alternate embodiment of the furniture.

FIG. 8 shows a top view of the embodiment of the furniture shown in FIG. 7.

FIG. 9 shows a front perspective view of the embodiment of the furniture shown in FIG. 7.

FIG. 10 shows an alternate front perspective view of the embodiment of the furniture shown in FIG. 7.

FIG. 11 shows a side view of the embodiment of the furniture shown in FIG. 7; and,

FIG. 12 shows an alternate side view of the embodiment of the furniture shown in FIG. 7.

The dashed lines shown in the drawings illustrate environmental structure and form no part of the claimed design.

**1 Claim, 10 Drawing Sheets**

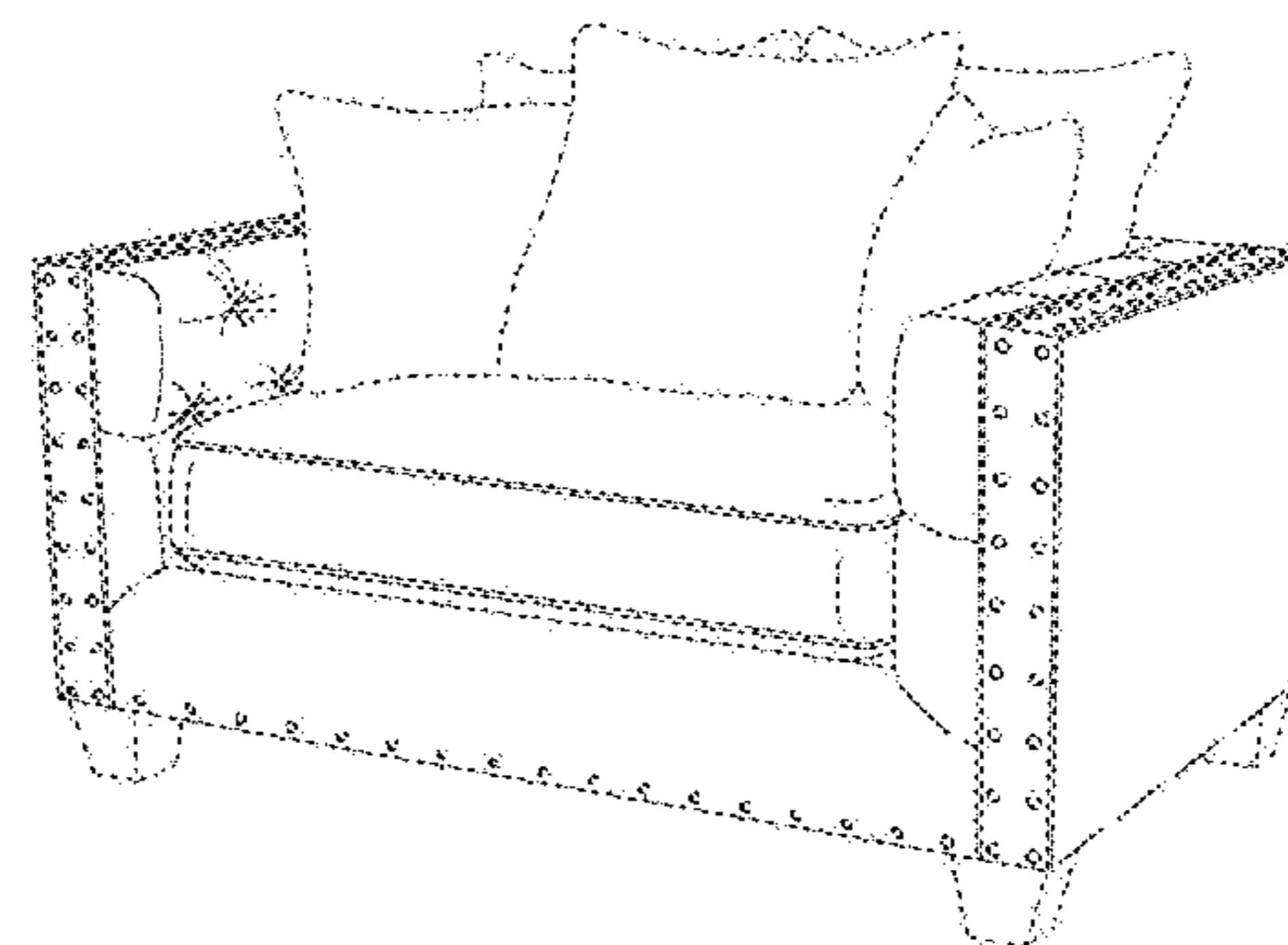
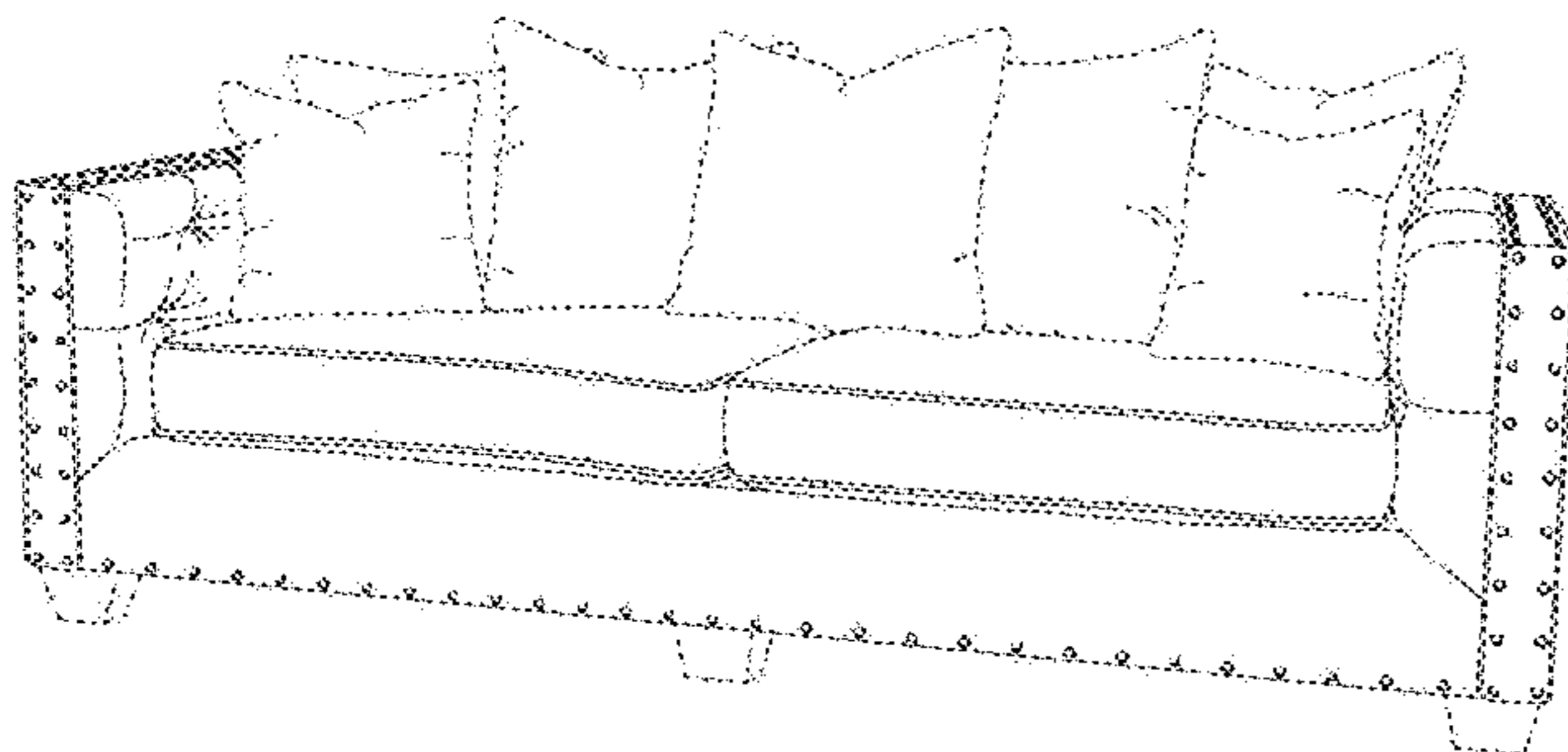

(56)

**References Cited**

U.S. PATENT DOCUMENTS

D498,074 S \* 11/2004 Gomez ..... D6/381  
D504,247 S \* 4/2005 Ricci ..... D6/381  
D552,871 S \* 10/2007 Natuzzi ..... D6/381  
D554,387 S \* 11/2007 Nicoletti ..... D6/381

D565,858 S \* 4/2008 Natuzzi ..... D6/381  
D584,524 S \* 1/2009 Ricci ..... D6/381  
D603,620 S \* 11/2009 Natuzzi ..... D6/381  
D617,112 S \* 6/2010 Tsai ..... D6/381  
D677,924 S \* 3/2013 Lenney et al. .... D6/381  
D683,158 S \* 5/2013 Banda ..... D6/381

\* cited by examiner

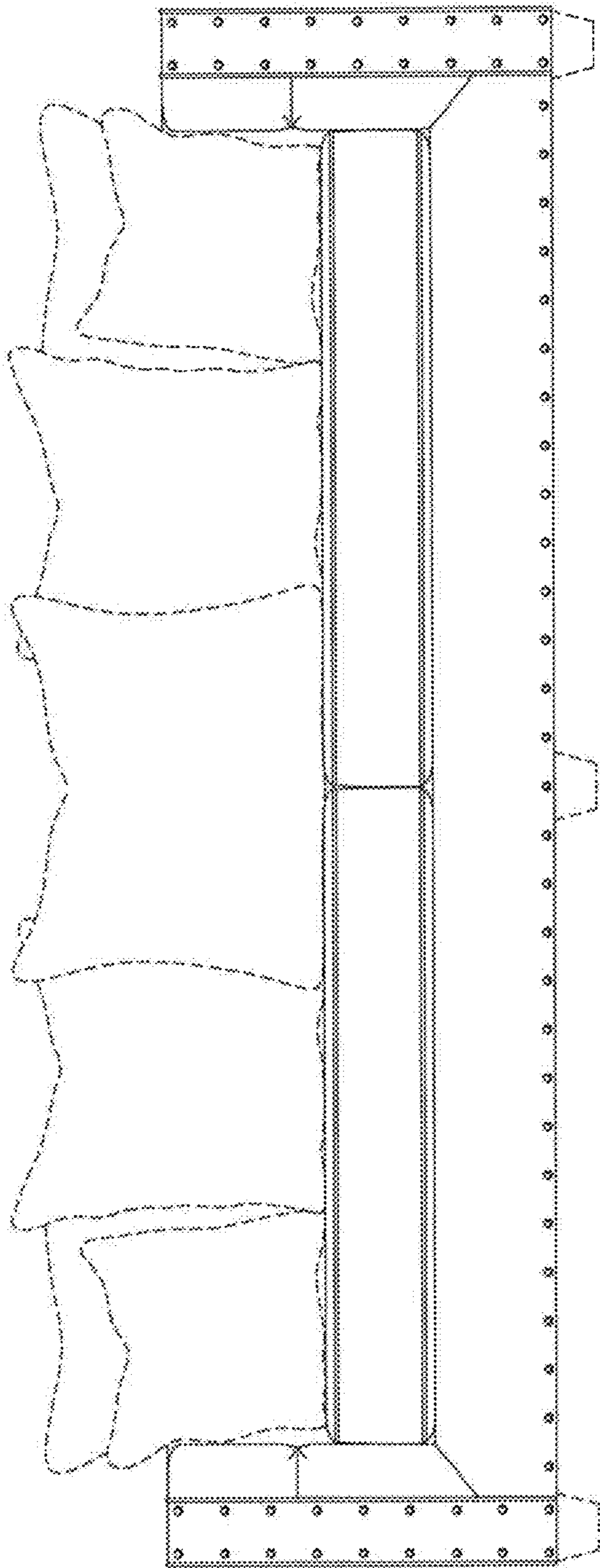

FIG. 1

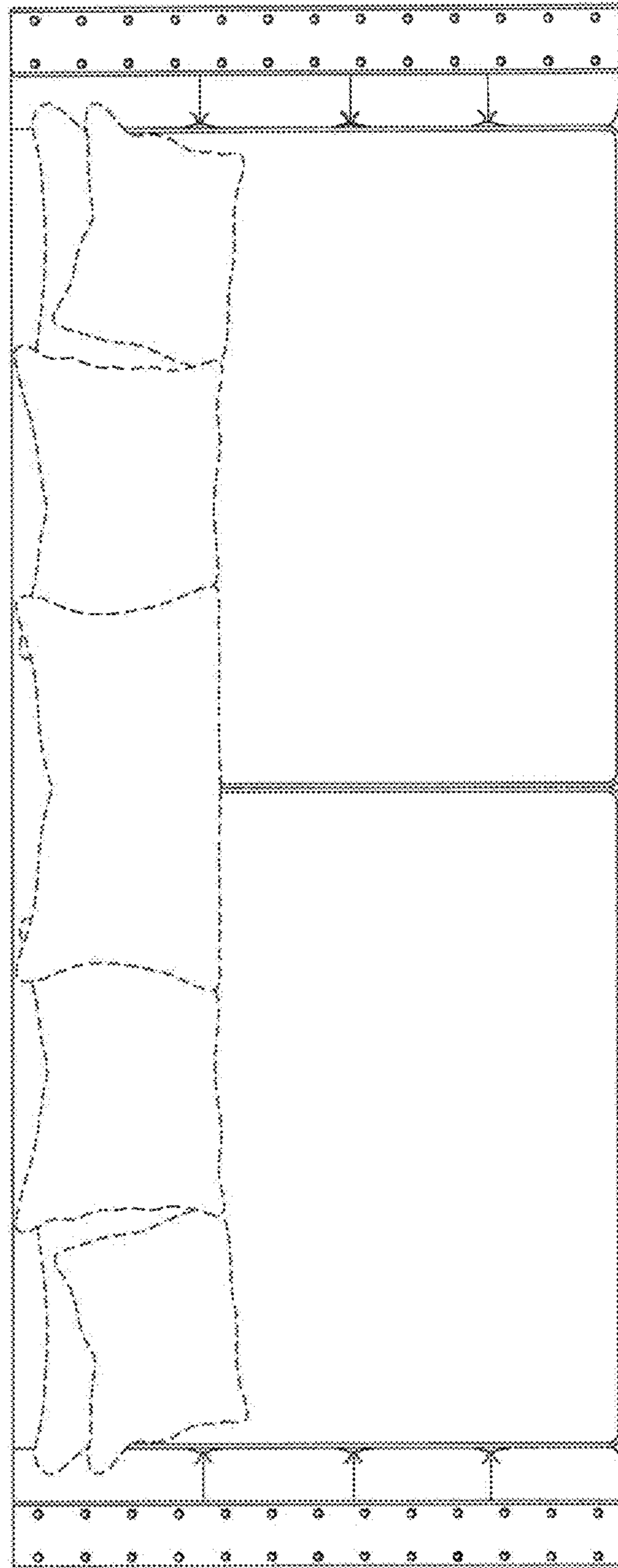

FIG. 2

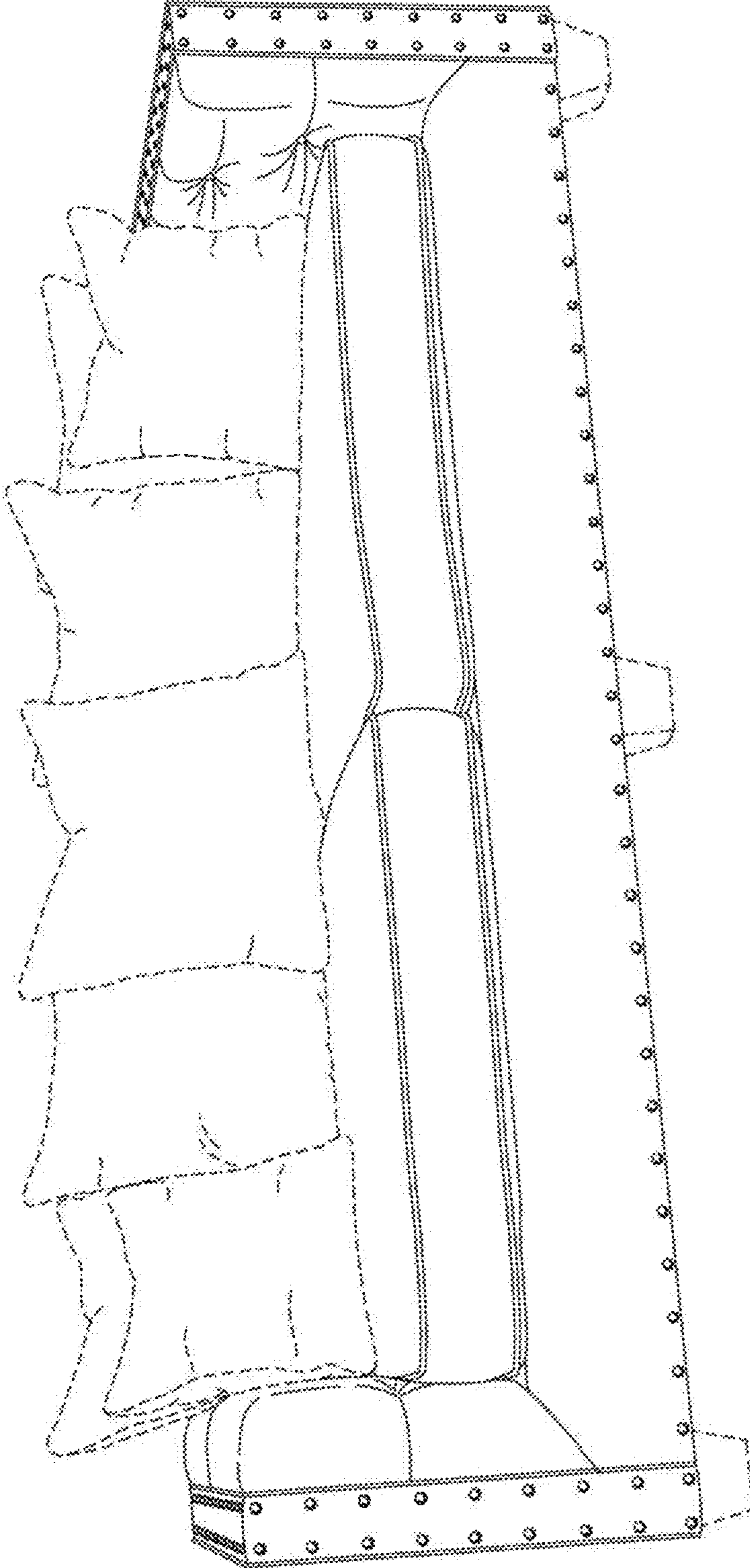

FIG. 3

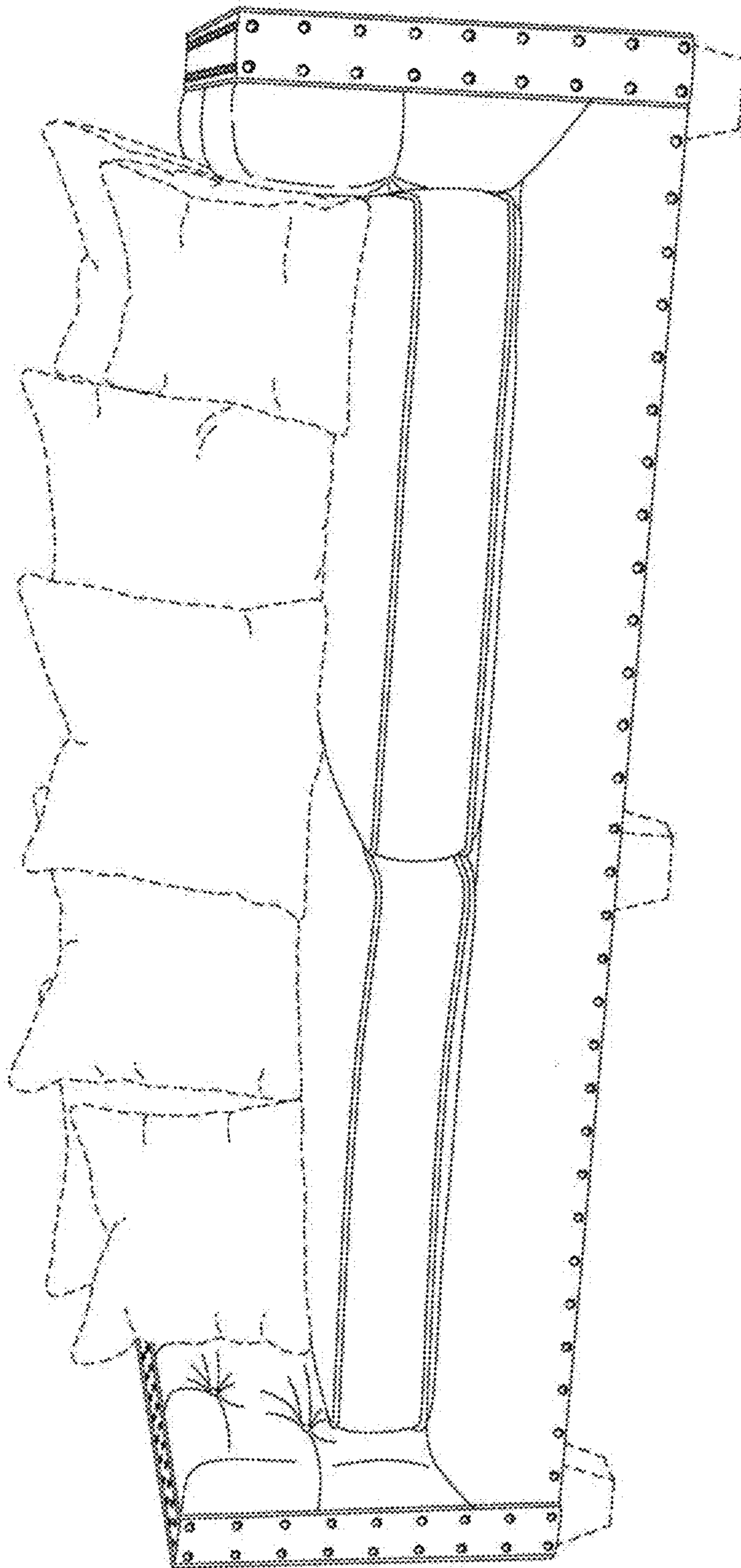

FIG. 4

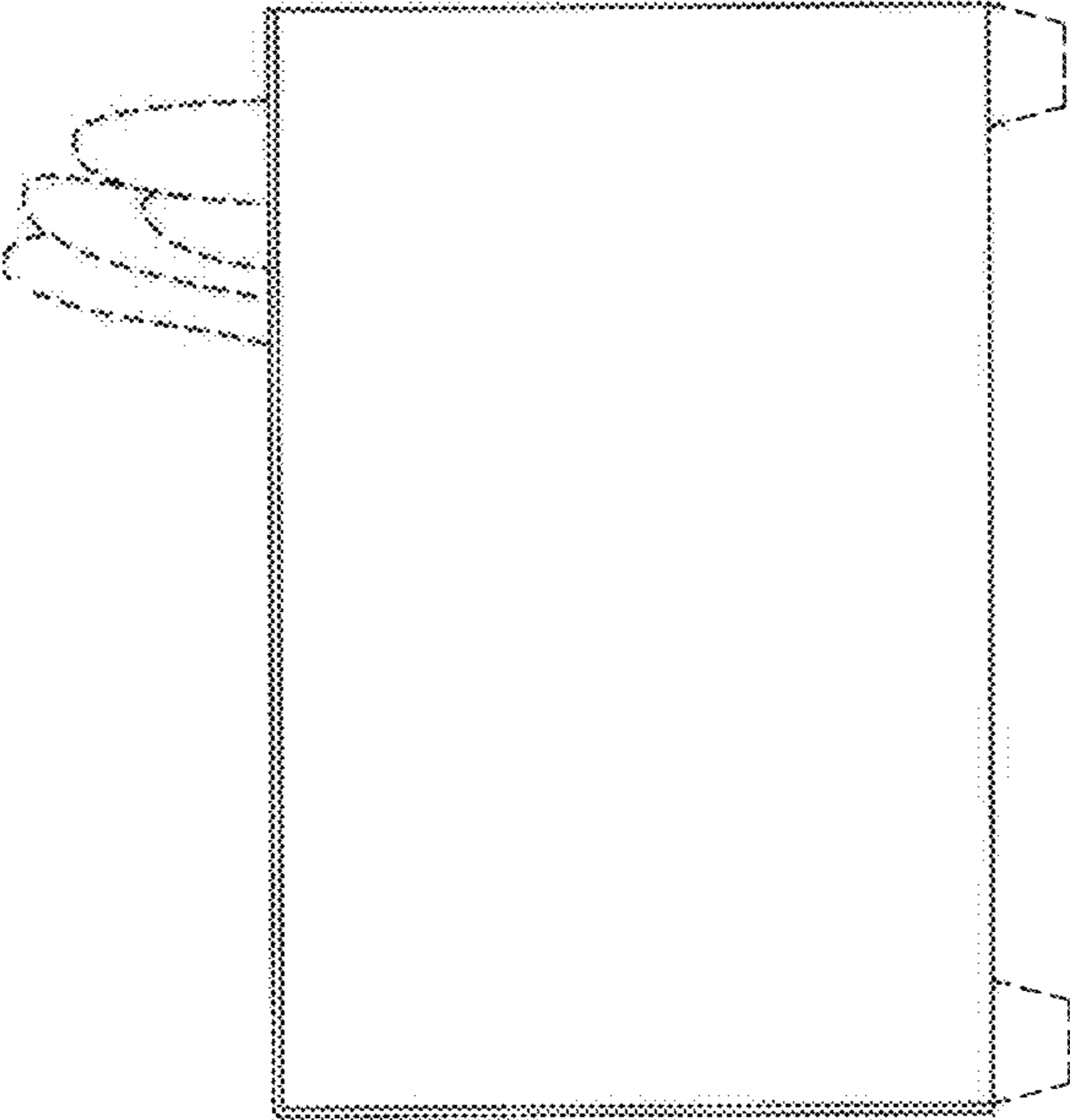

FIG. 5

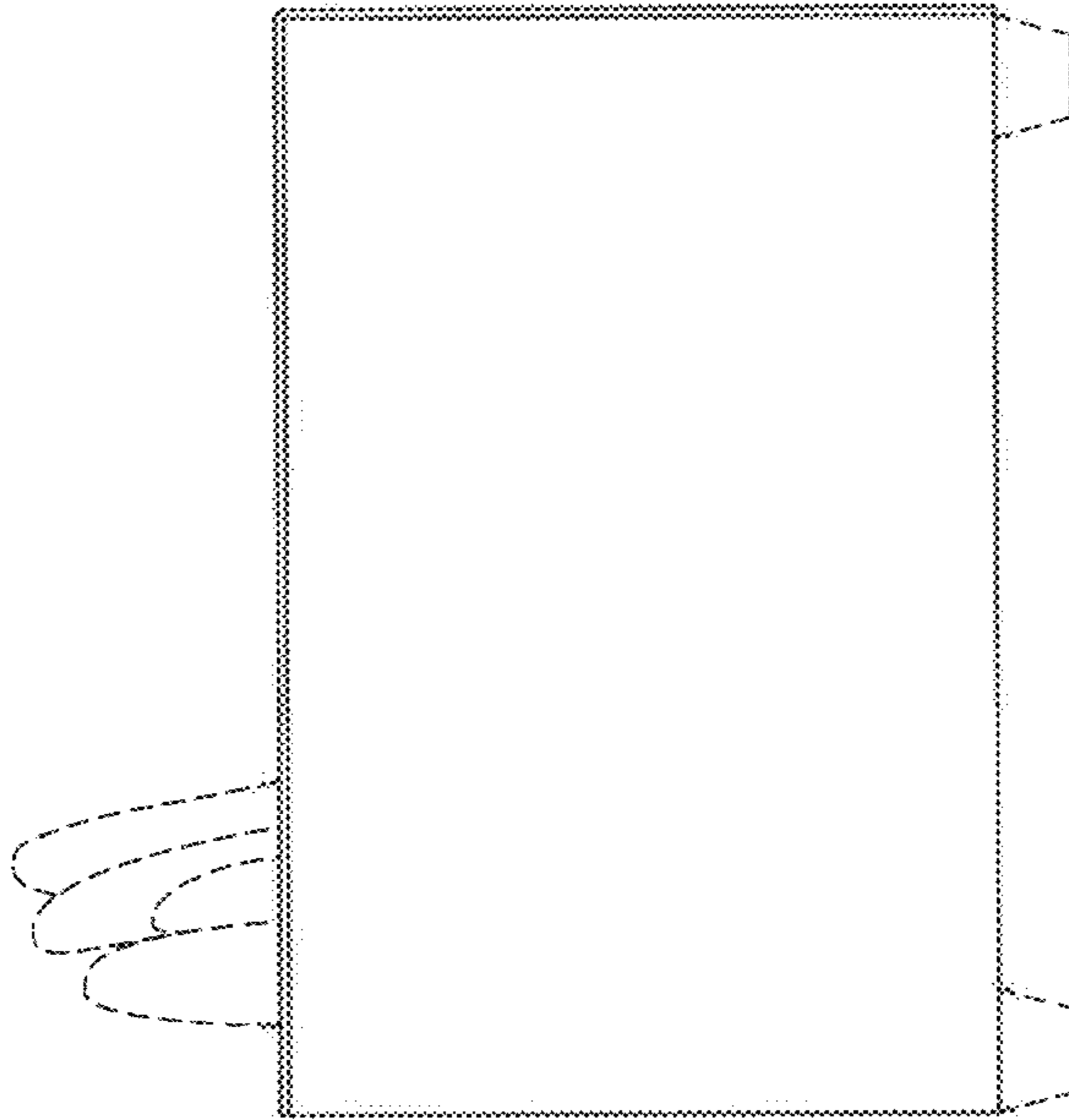

FIG. 6

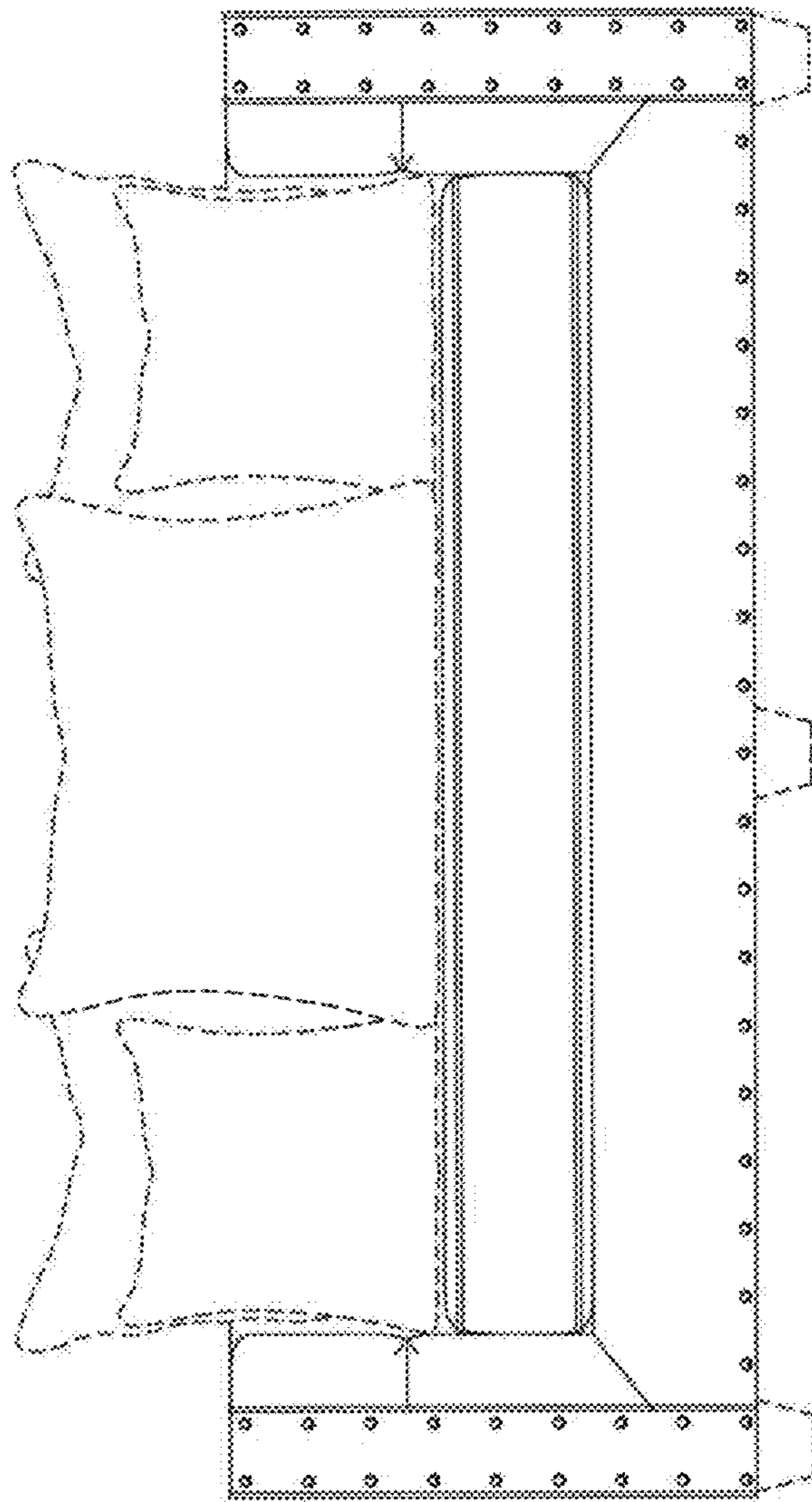

FIG. 7



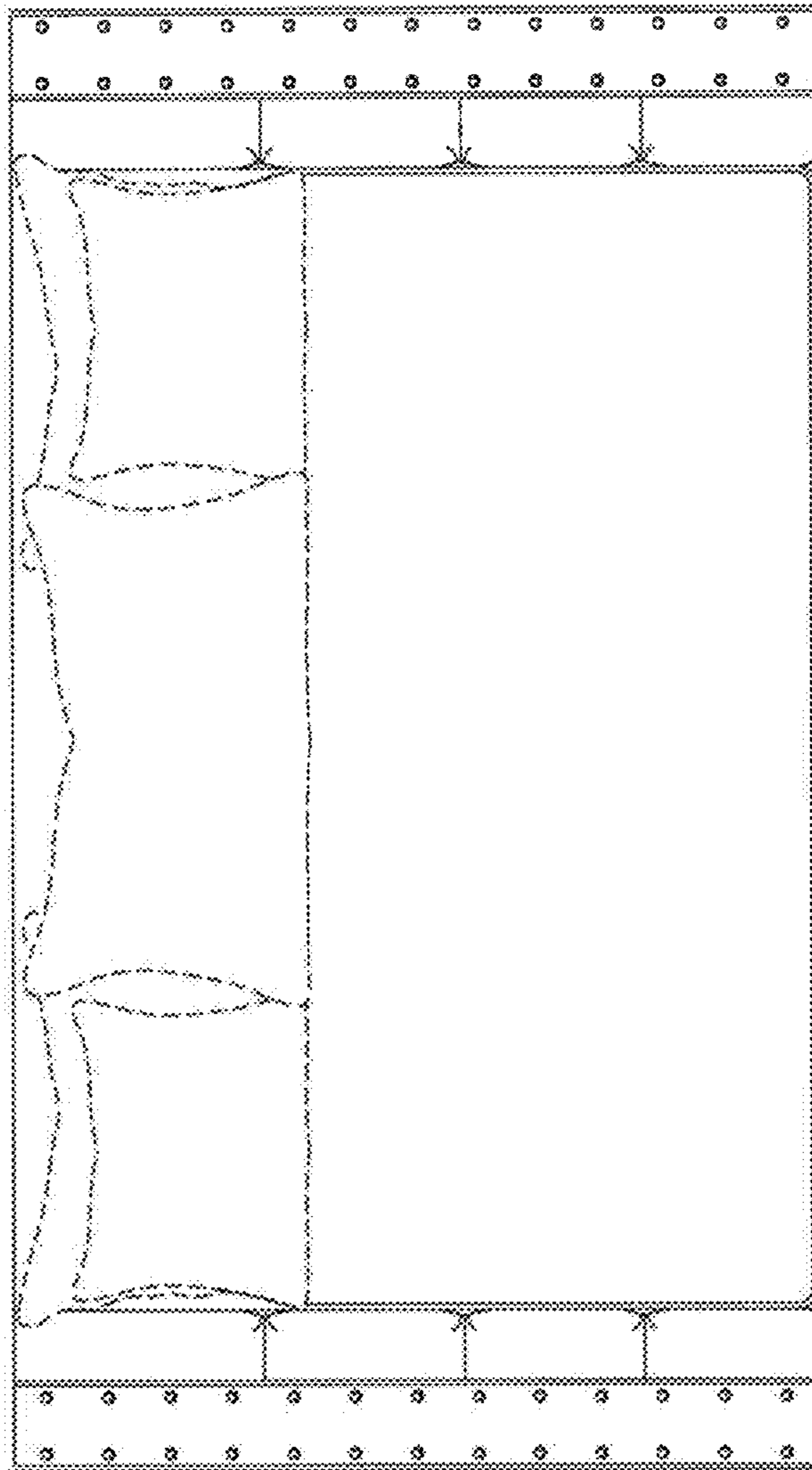

FIG. 8

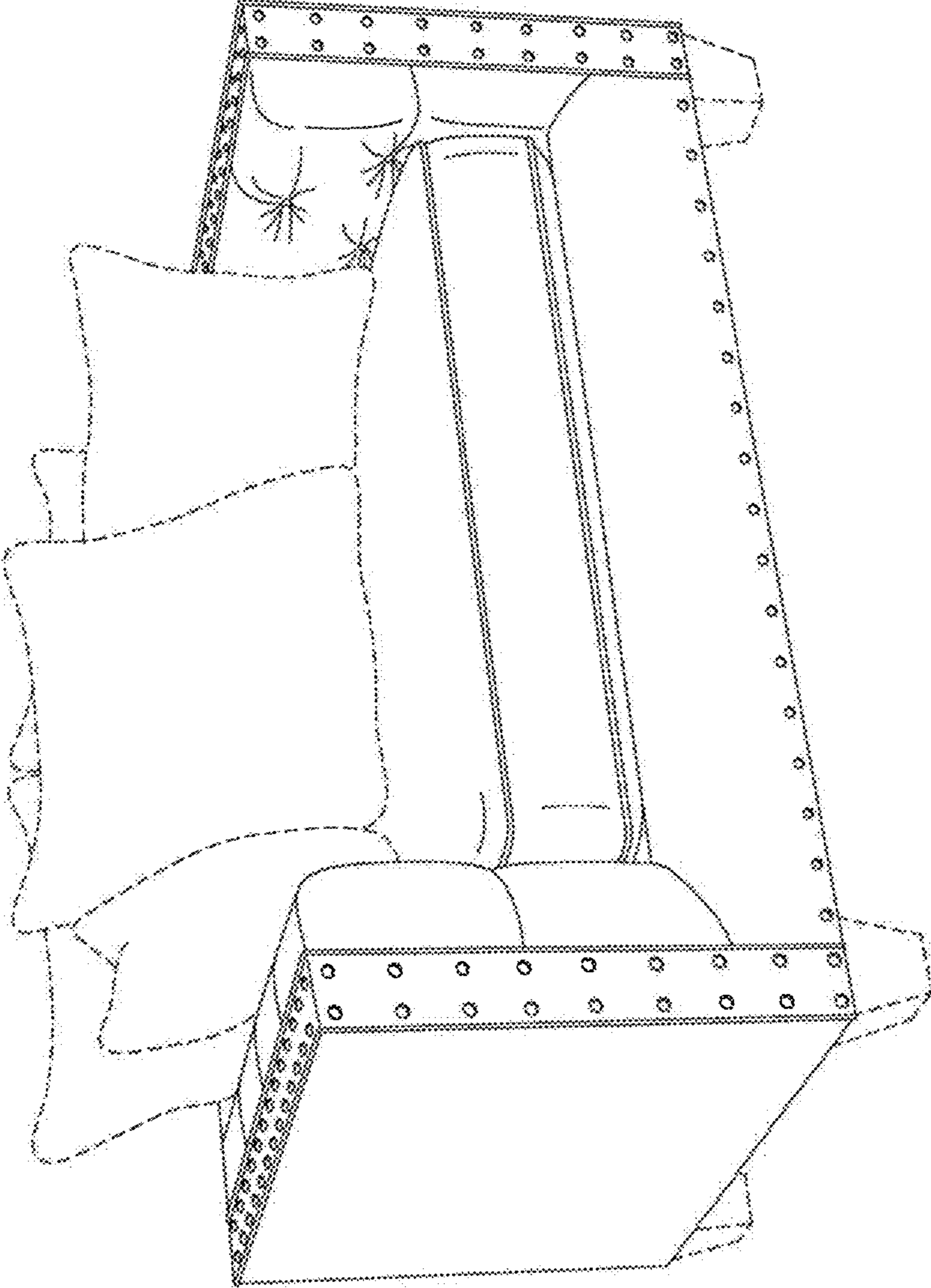

FIG. 9

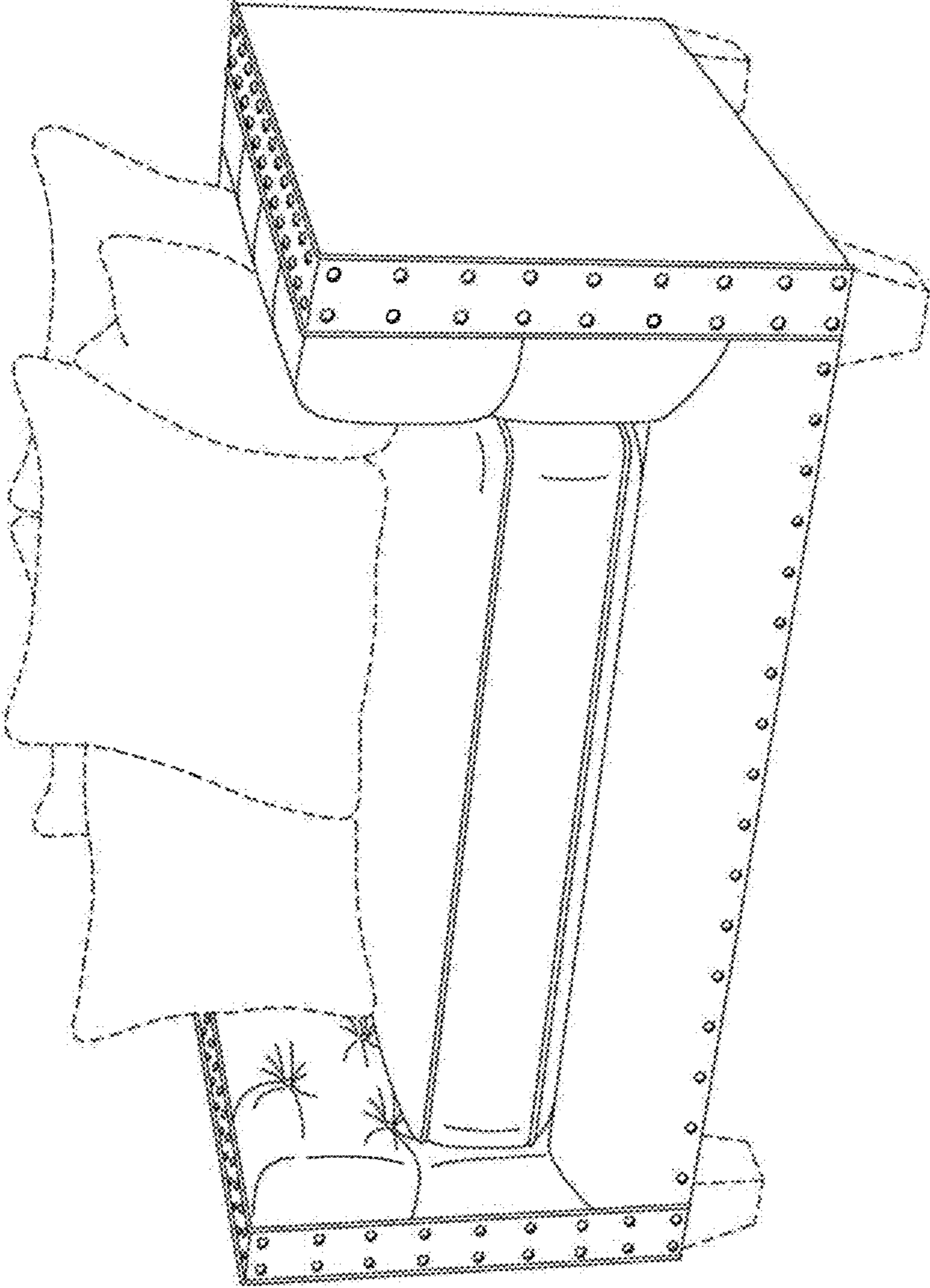

FIG. 10

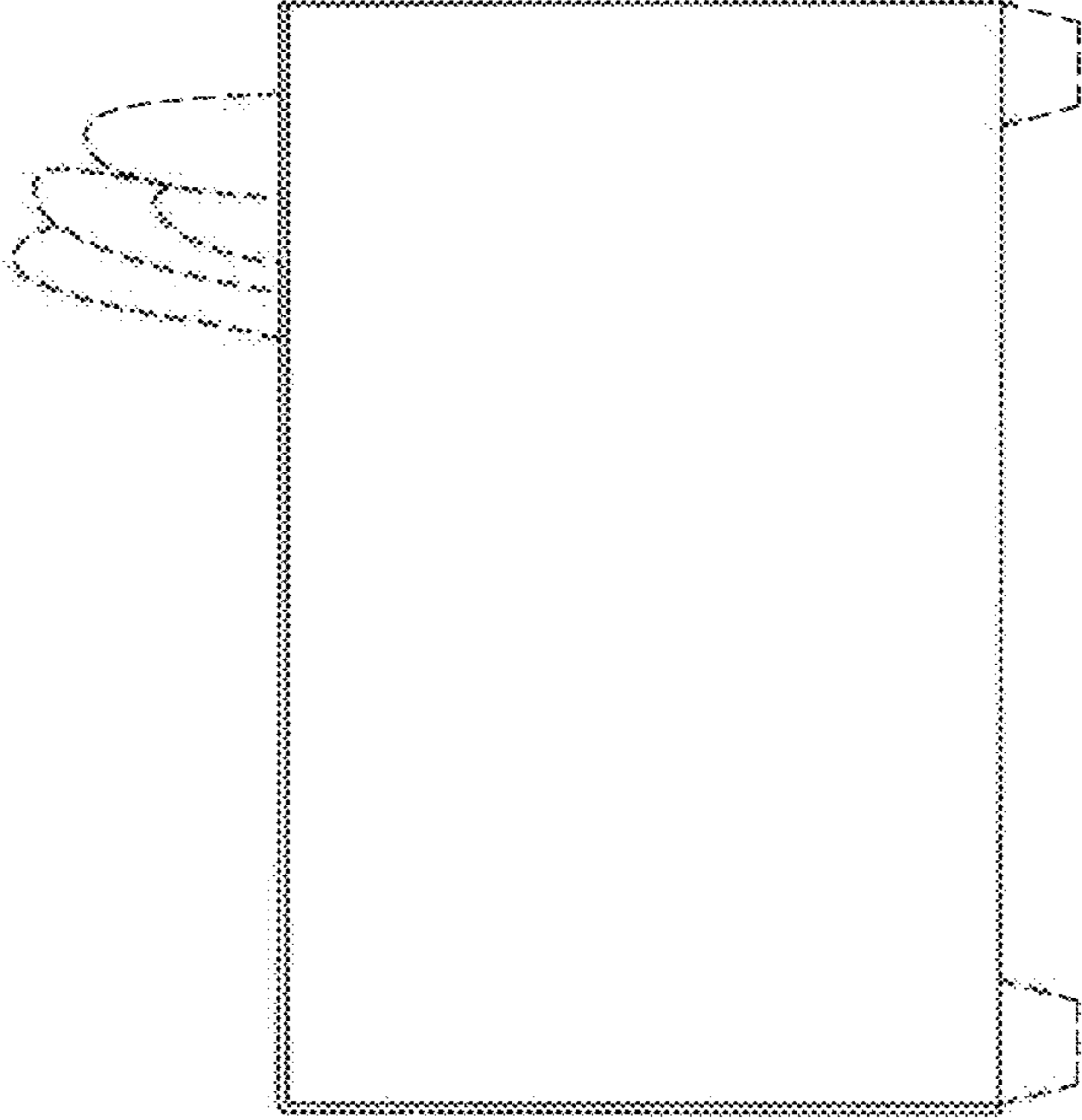

FIG. 12

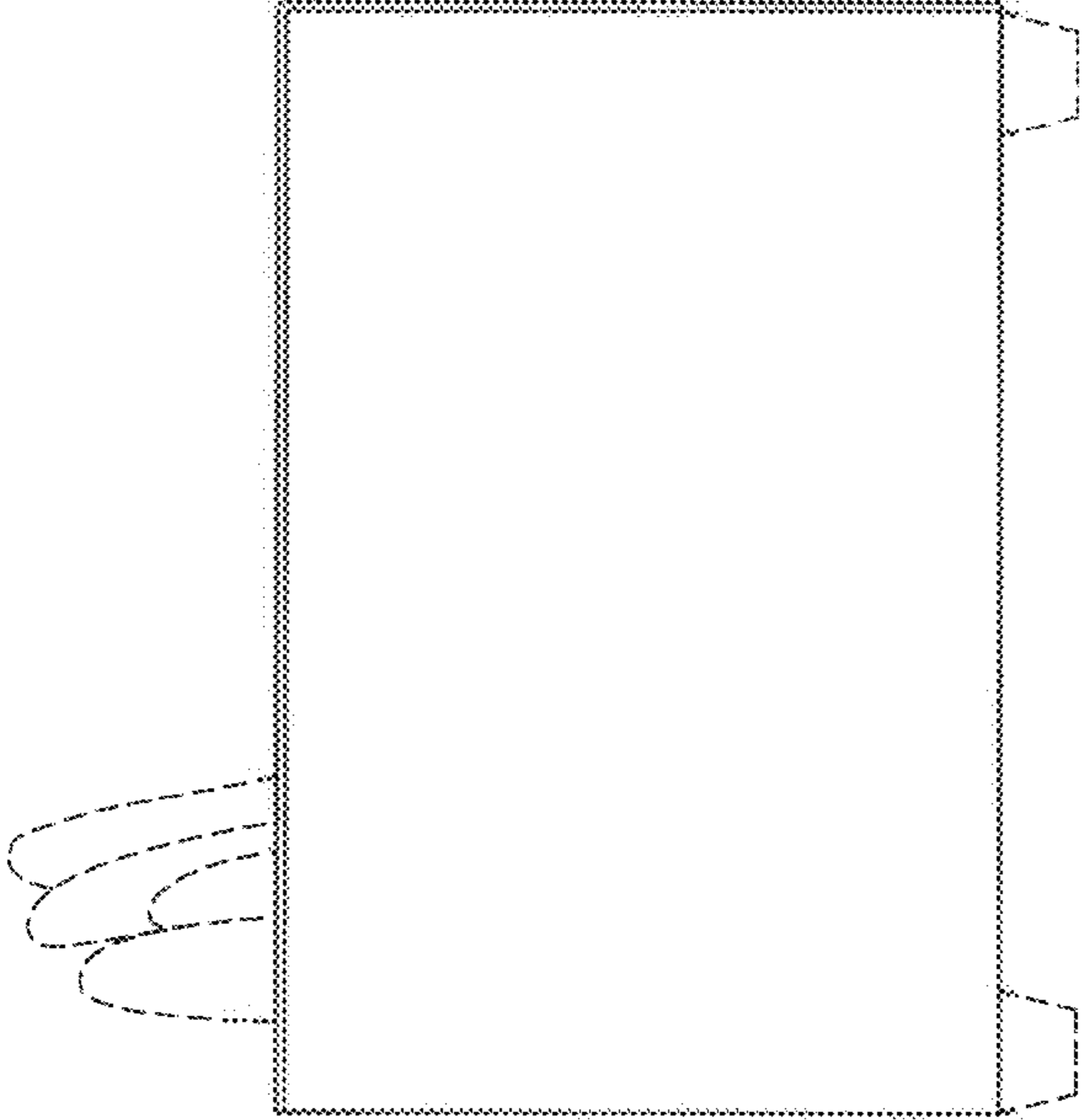

FIG. 11