

US00D691662S

(12) **United States Design Patent**  
**Schwarz et al.**

(10) **Patent No.:** **US D691,662 S**

(45) **Date of Patent:** **\*\* Oct. 15, 2013**

(54) **CRANE STYLE ARCADE GAME**

(76) Inventors: **Ryan Schwarz**, Bennington, NE (US);  
**Laura Schwarz**, Bennington, NE (US);  
**Michael Bryant, Jr.**, Bennington, NE  
(US)

5,967,892 A \* 10/1999 Shoemaker, Jr. .... 463/7  
6,139,429 A \* 10/2000 Shoemaker, Jr. .... 463/7  
D433,716 S \* 11/2000 Robrahn et al. .... D21/325  
D465,810 S \* 11/2002 Bartholomew et al. .... D20/1  
D505,700 S \* 5/2005 Singer ..... D21/327  
D596,677 S \* 7/2009 Tsuda ..... D21/325

\* cited by examiner

(\*\*) Term: **14 Years**

*Primary Examiner* — Prabhakar Deshmukh

(21) Appl. No.: **29/430,813**

(74) *Attorney, Agent, or Firm* — Kutak Rock LLP; Sean P. Connolly

(22) Filed: **Aug. 30, 2012**

(51) **LOC (9) Cl.** ..... **21-01**

(52) **U.S. Cl.**

USPC ..... **D21/325**

(58) **Field of Classification Search**

USPC ..... D21/325, 329, 369, 811; D20/1-9;  
273/148 B, 447, 448, 460, 461; 463/46,  
463/47, 7, 25; 221/75, 133, 155, 212, 282,  
221/286, 312 A, 312 C

See application file for complete search history.

(57) **CLAIM**

The ornamental design for a crane style arcade game, as shown and described.

**DESCRIPTION**

FIG. 1 is a front elevational view of a crane style arcade game showing our new design;

FIG. 2 is a rear elevational view thereof;

FIG. 3 is a left side elevational view thereof;

FIG. 4 is a right side elevational view thereof;

FIG. 5 is atop plan view thereof;

FIG. 6 is a bottom plan view thereof; and,

FIG. 7 is a perspective view thereof.

The broken lines depict the disclaimed portions and form no part of the claimed design.

(56) **References Cited**

**U.S. PATENT DOCUMENTS**

D96,564 S \* 8/1935 Simpkins ..... D21/325  
5,344,199 A \* 9/1994 Carstens et al. .... 463/17  
D355,584 S \* 2/1995 Clivio ..... D8/359  
5,397,134 A \* 3/1995 Fishman et al. .... 463/25  
D366,304 S \* 1/1996 Lewis ..... D21/811  
5,549,372 A \* 8/1996 Lewis ..... 312/114  
5,855,374 A \* 1/1999 Shoemaker, Jr. .... 273/447

**1 Claim, 6 Drawing Sheets**

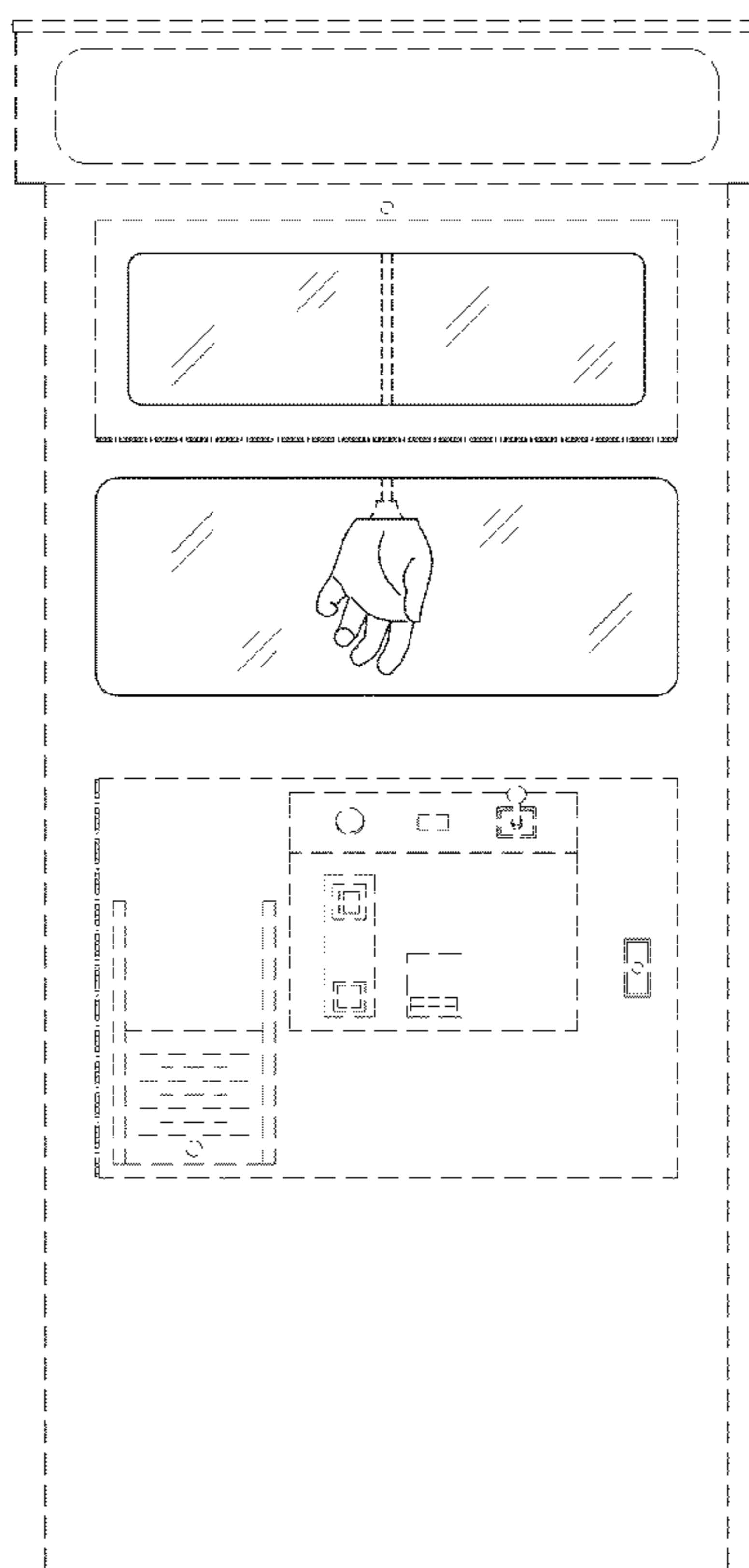

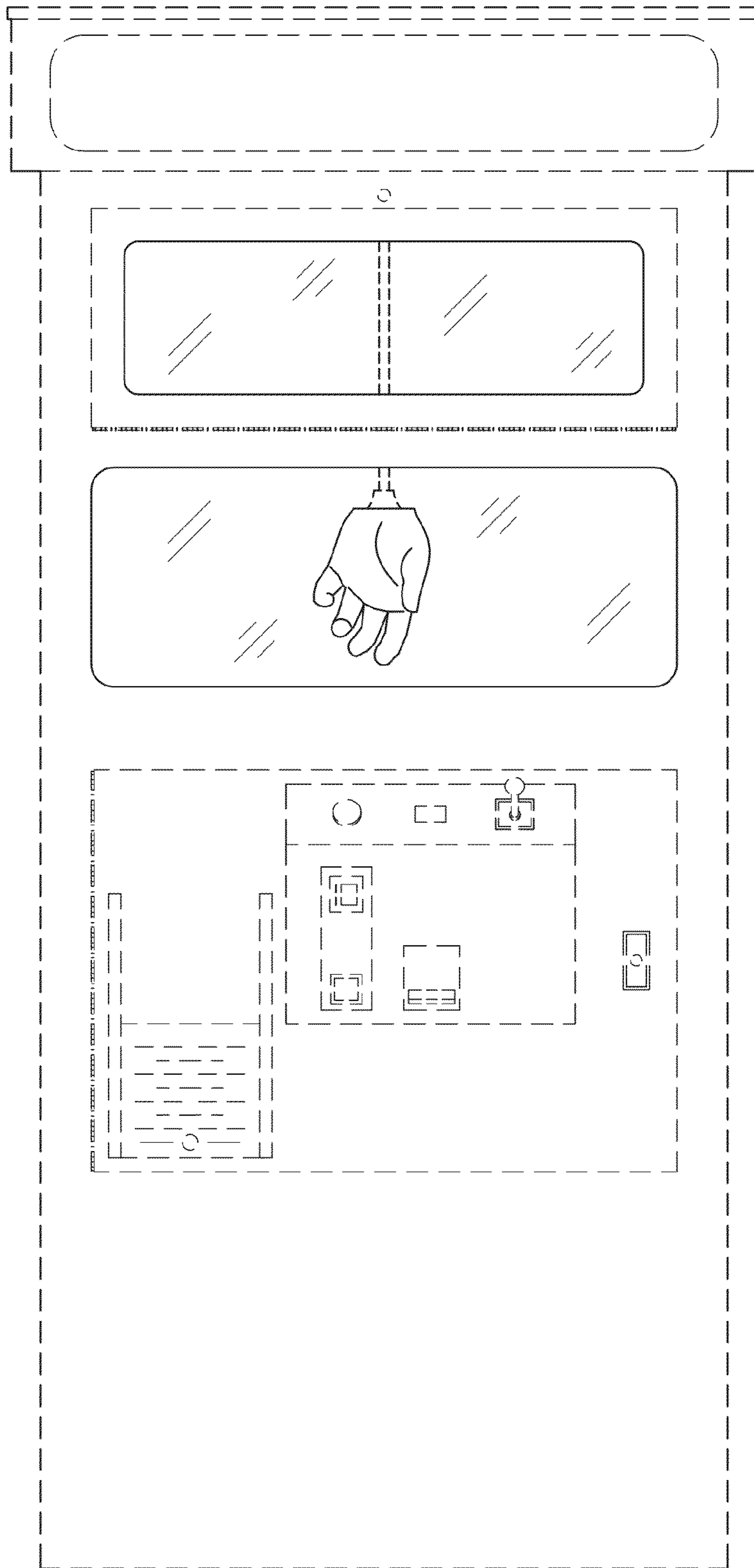
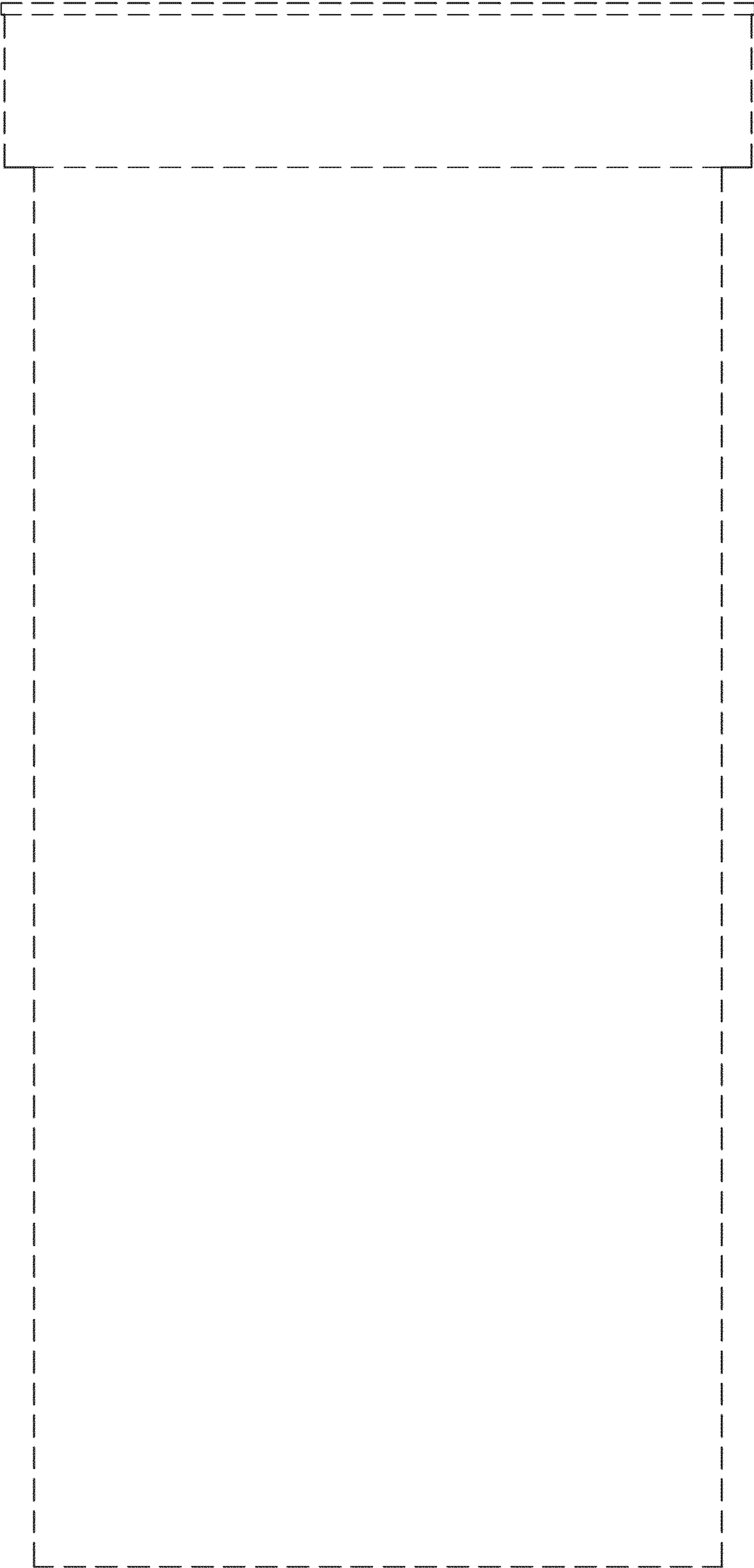

FIG. 1



**FIG. 2**

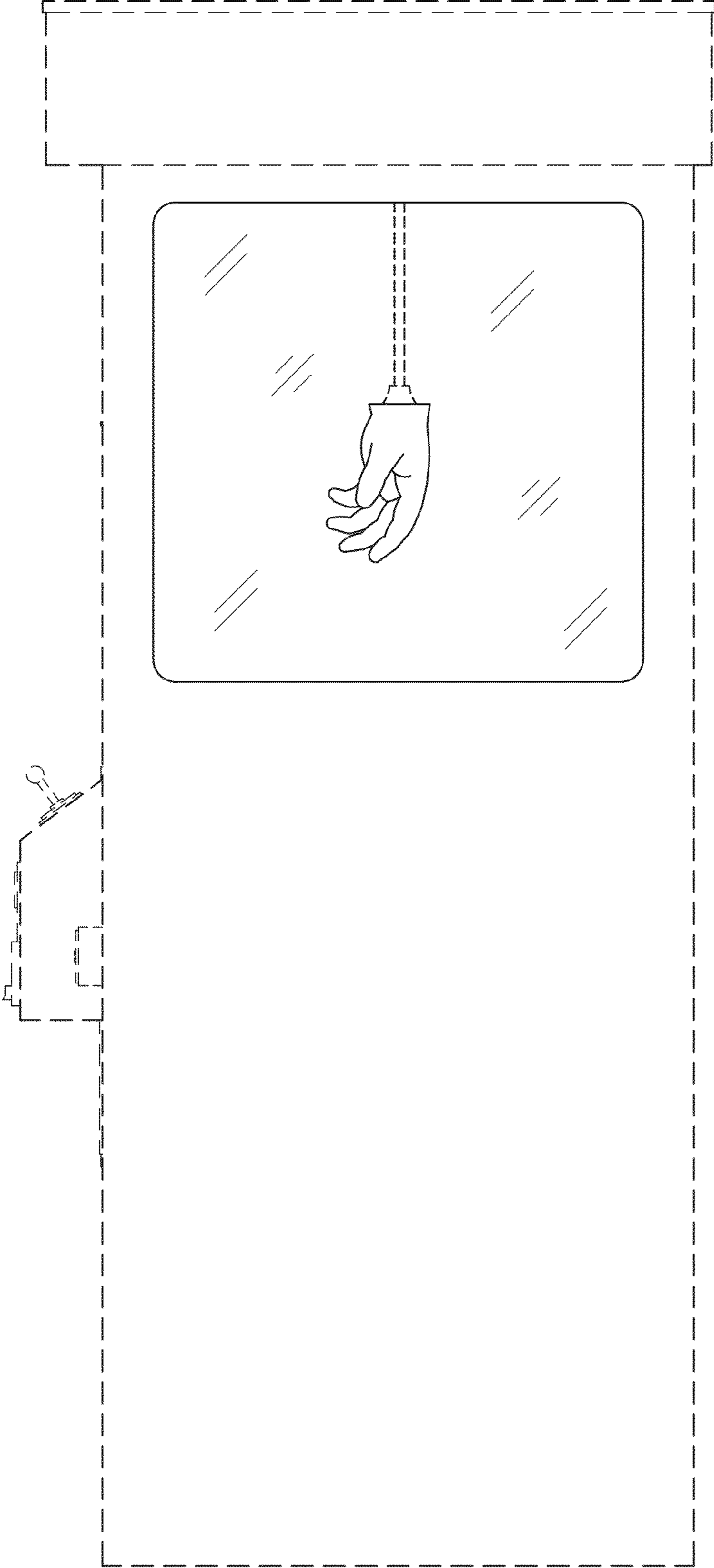

FIG. 3

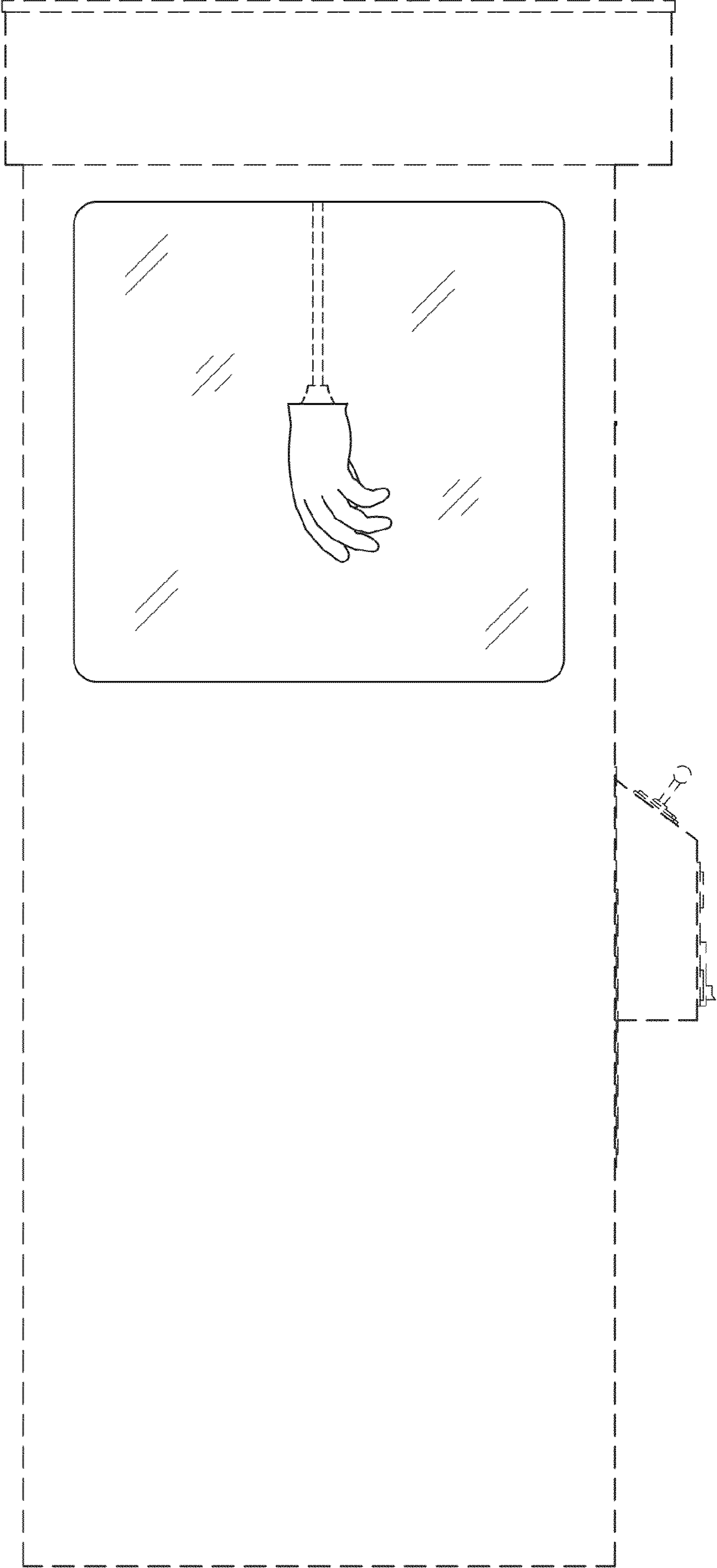
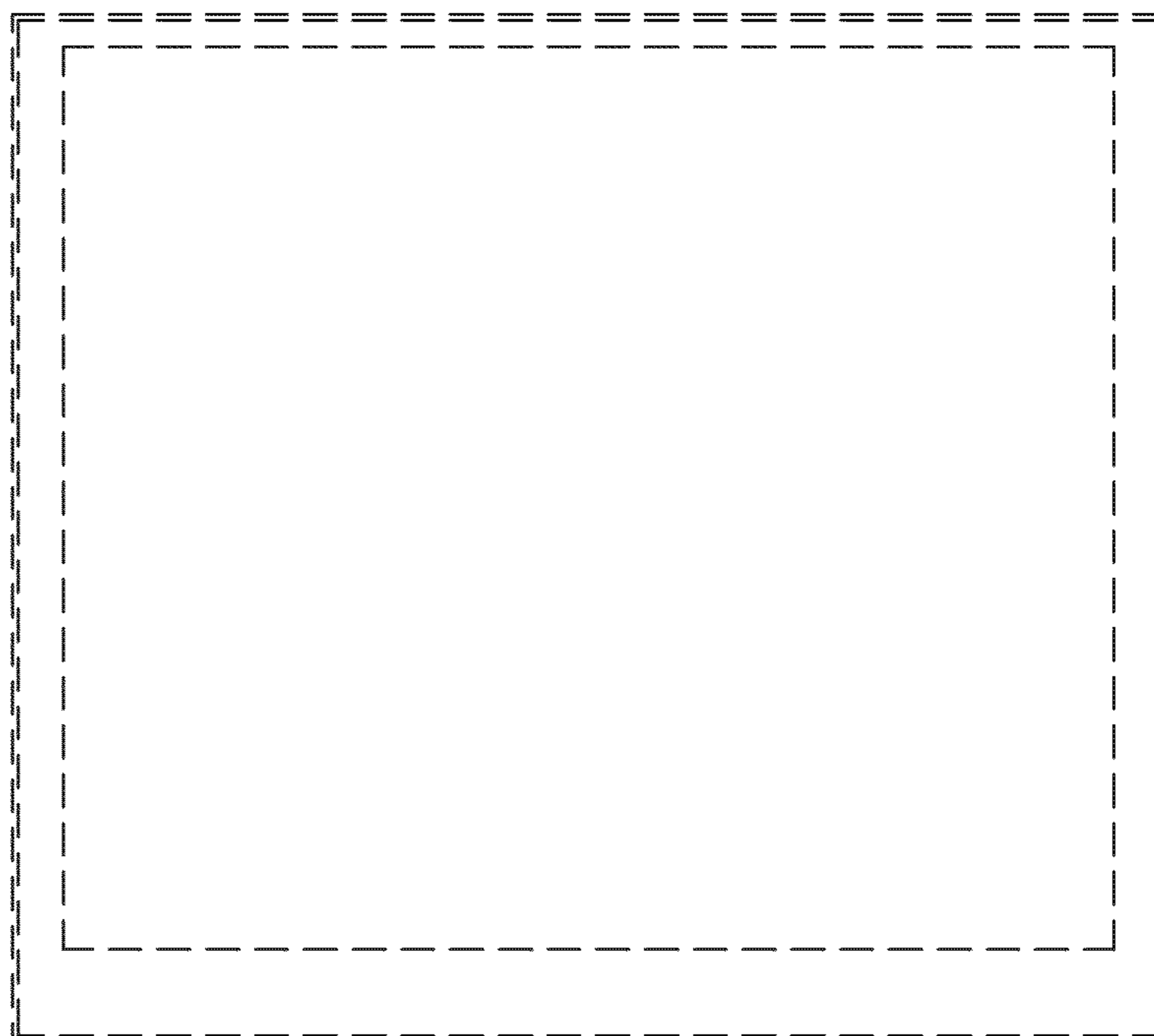

FIG. 4



**FIG. 5**



**FIG. 6**

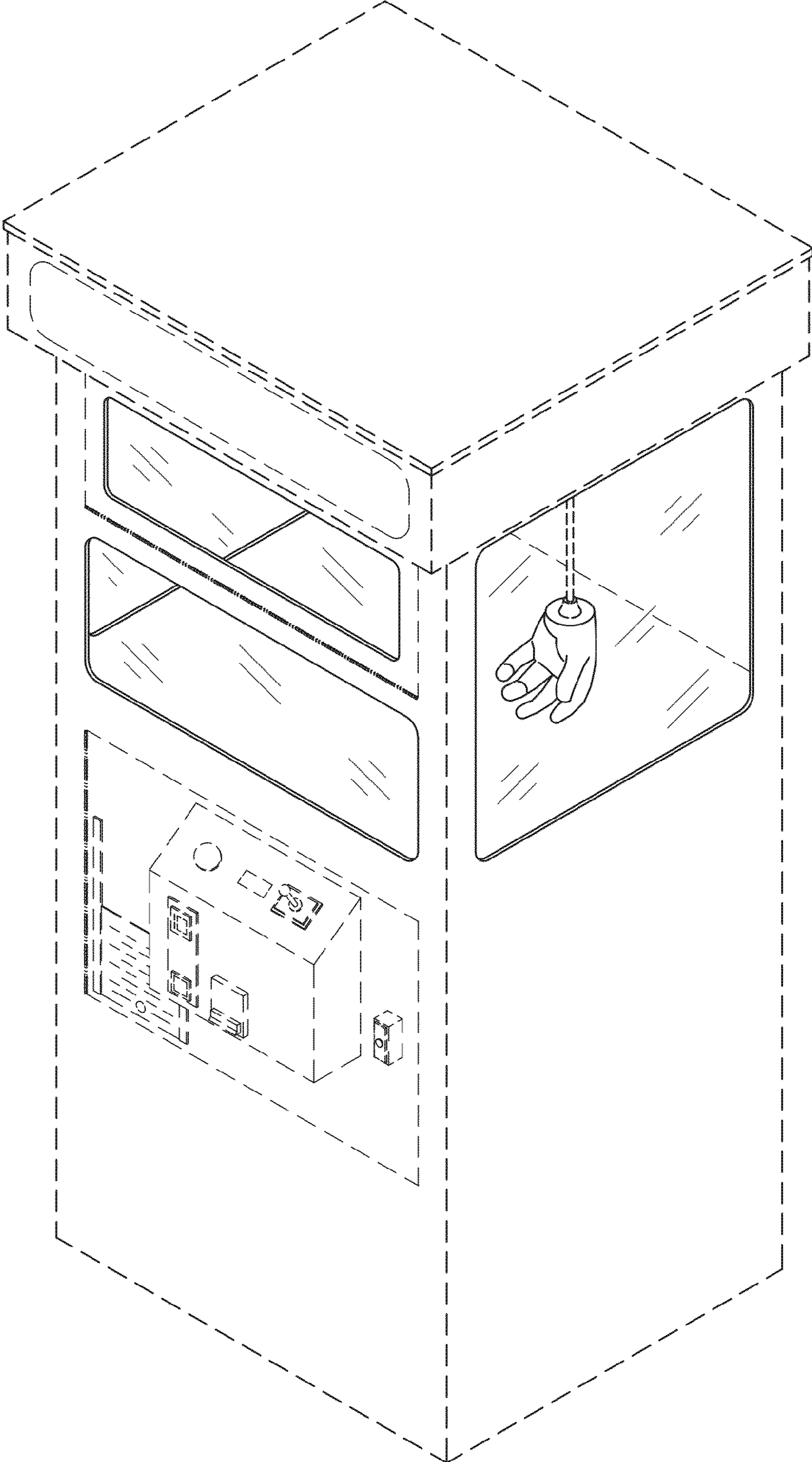

FIG. 7