

US00D691651S

(12) **United States Design Patent**
Kim

(10) **Patent No.:** **US D691,651 S**
(45) **Date of Patent:** **** Oct. 15, 2013**

(54) **CAMERA STRAP**

(71) Applicant: **Samsung Electronics Co., Ltd.**,
Suwon-si (KR)

(72) Inventor: **Min-Geun Kim**, Goyang-Si (KR)

(73) Assignee: **Samsung Electronics Co., Ltd.**,
Suwon-si (KR)

(**) Term: **14 Years**

(21) Appl. No.: **29/446,909**

(22) Filed: **Feb. 28, 2013**

(30) **Foreign Application Priority Data**

Aug. 28, 2012 (KR) 30-2012-0041125

(51) **LOC (9) Cl.** **16-05**

(52) **U.S. Cl.**
USPC **D16/242**

(58) **Field of Classification Search**
USPC D16/237, 242, 243-245; D14/511;
396/5, 419-428; 224/255, 257-258;
D3/215, 267, 327-328; 381/385;
D2/624, 627; D30/152

See application file for complete search history.

(56) **References Cited**

U.S. PATENT DOCUMENTS

D292,750 S * 11/1987 Smith D3/215
D462,523 S * 9/2002 Kalbach D3/327
D532,201 S * 11/2006 Esch D3/327

D623,860 S * 9/2010 Kope et al. D3/327
D623,861 S * 9/2010 Kope et al. D3/327
8,047,729 B2 * 11/2011 Kope et al. 396/423
D655,080 S * 3/2012 Burrows D3/215
8,295,533 B1 * 10/2012 Schachtman 381/385

* cited by examiner

Primary Examiner — Susan Bennett Hattan

Assistant Examiner — Vy Koenig

(74) *Attorney, Agent, or Firm* — NSIP Law

(57) **CLAIM**

The ornamental design for a camera strap, as shown and described.

DESCRIPTION

FIG. 1 is a front perspective view of a camera strap;
FIG. 2 is a front view of the camera strap of FIG. 1;
FIG. 3 is a rear view of the camera strap of FIG. 1;
FIG. 4 is a left-side view of the camera strap of FIG. 1;
FIG. 5 is a right-side view of the camera strap of FIG. 1;
FIG. 6 is a top plan view of the camera strap of FIG. 1;
FIG. 7 is a bottom plan view of the camera strap of FIG. 1;
FIG. 8 is a front perspective view of a second embodiment of the invention;
FIG. 9 is a front view of the camera strap of FIG. 8;
FIG. 10 is a rear view of the camera strap of FIG. 8;
FIG. 11 is a left-side view of the camera strap of FIG. 8;
FIG. 12 is a right-side view of the camera strap of FIG. 8;
FIG. 13 is a top view of the camera strap of FIG. 8; and
FIG. 14 is a bottom view of the camera strap of FIG. 8.
Features shown in broken lines in FIGS. 1, 6 and 7, form no part of the claimed design.

1 Claim, 10 Drawing Sheets

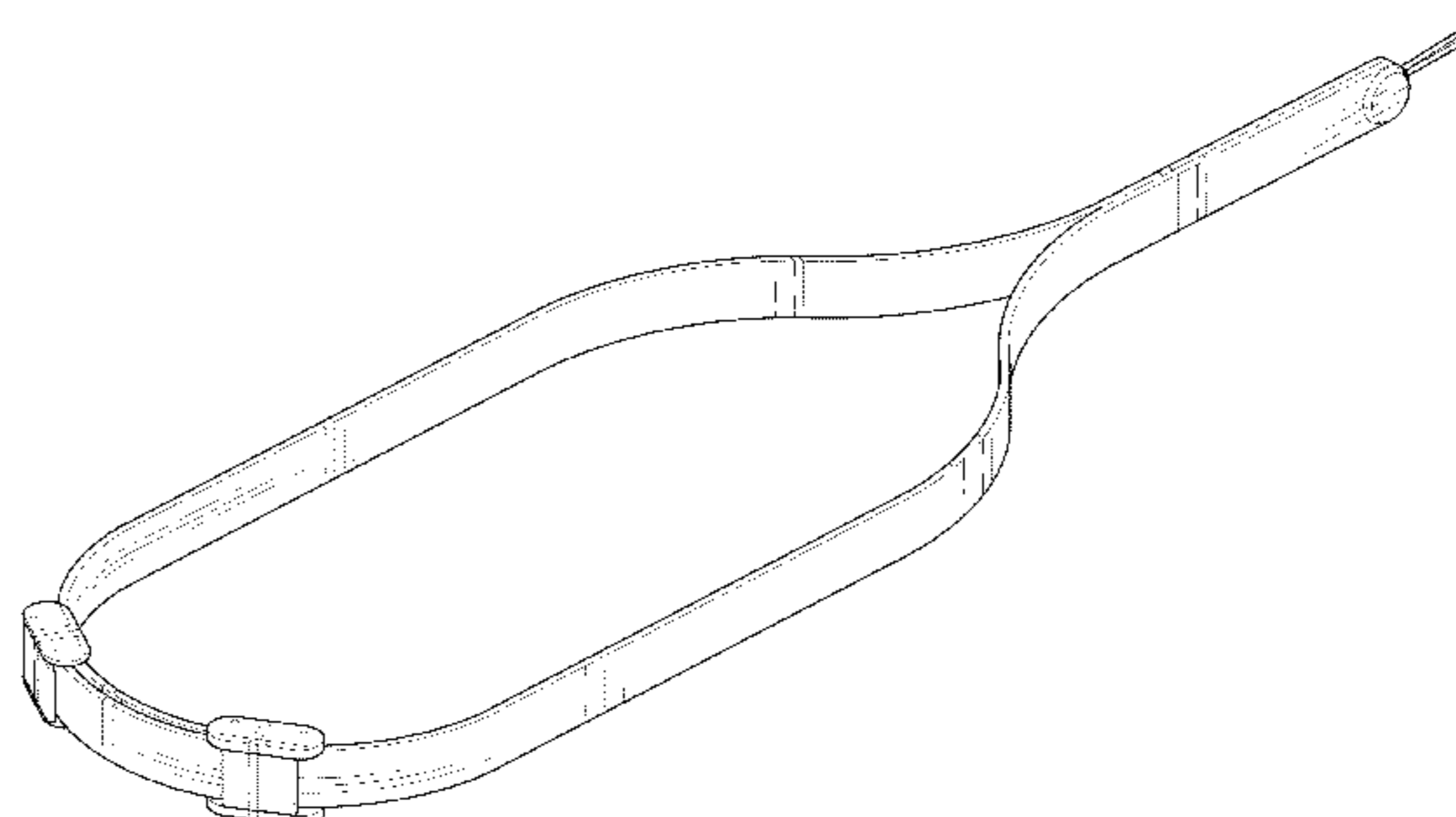
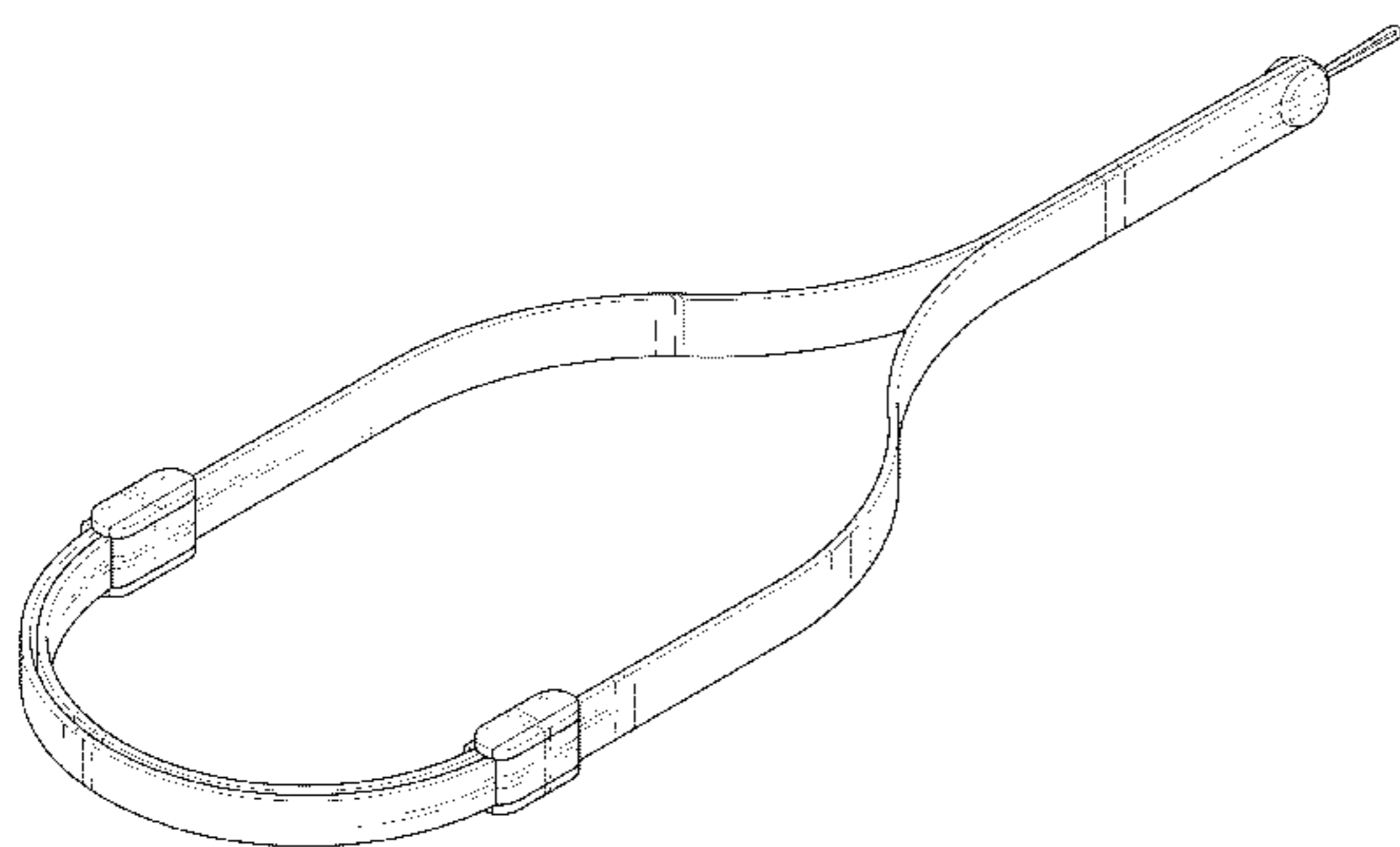

FIG. 1

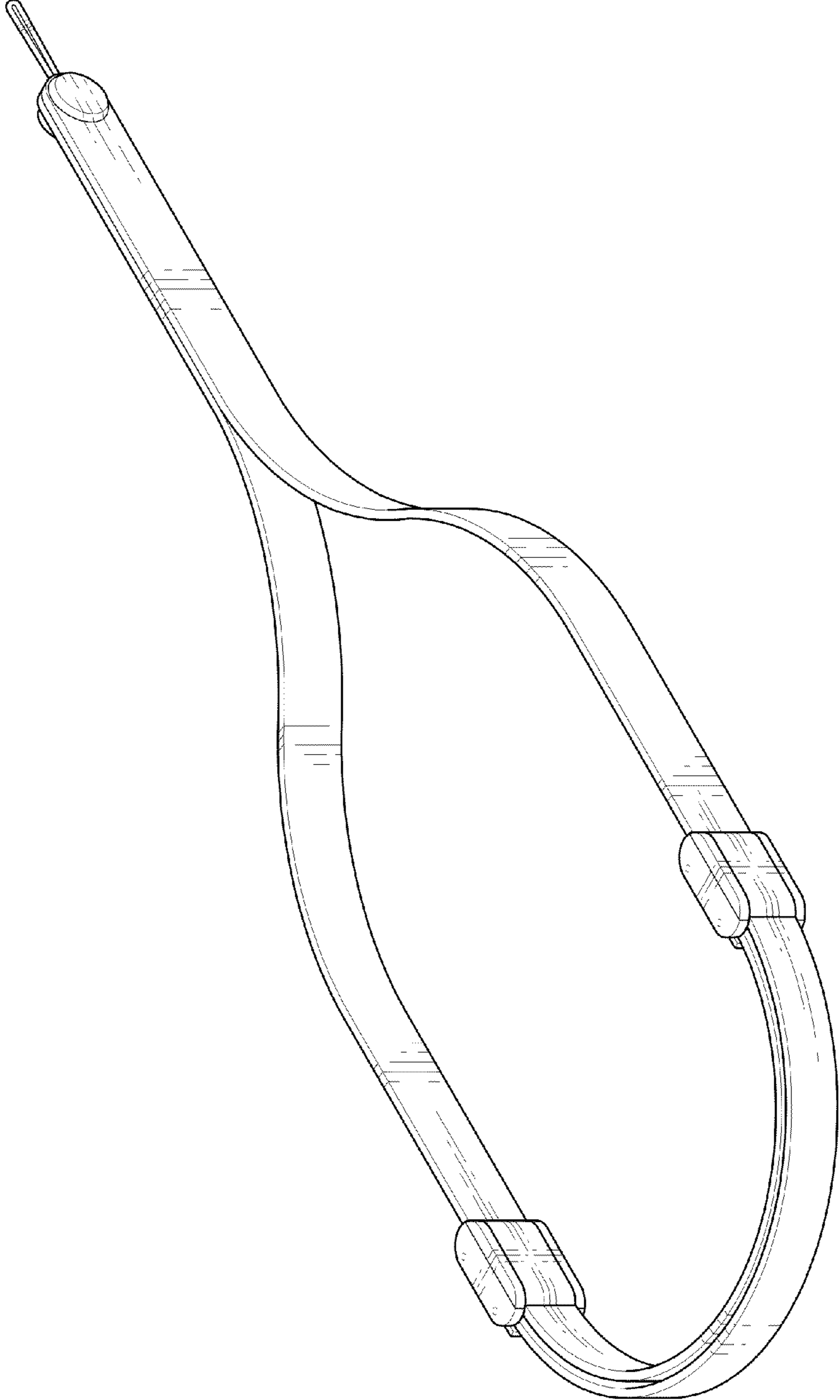

FIG. 2

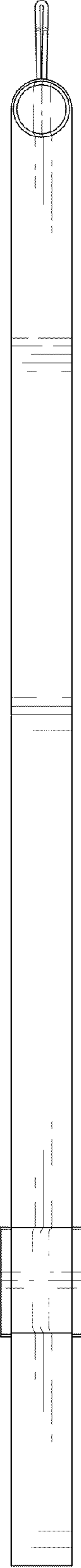

FIG. 3

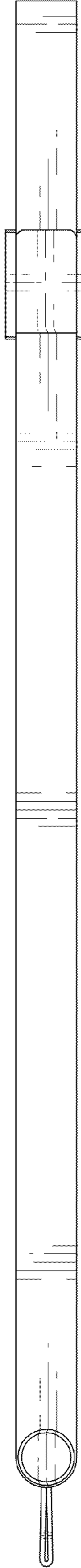

FIG. 4

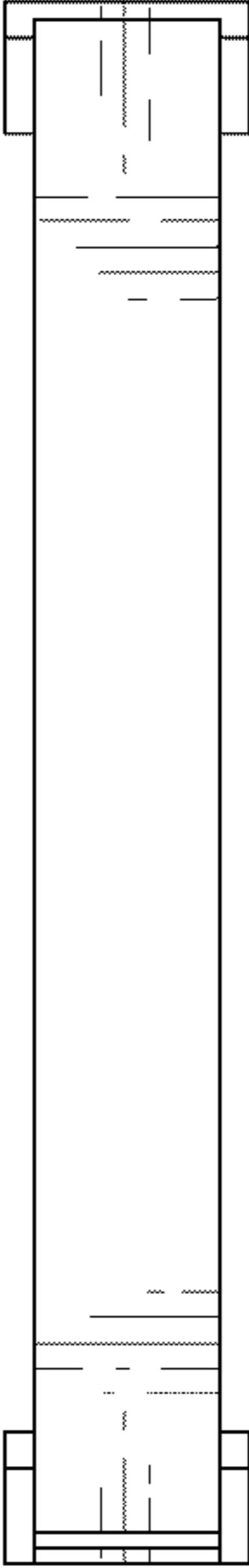

FIG. 5

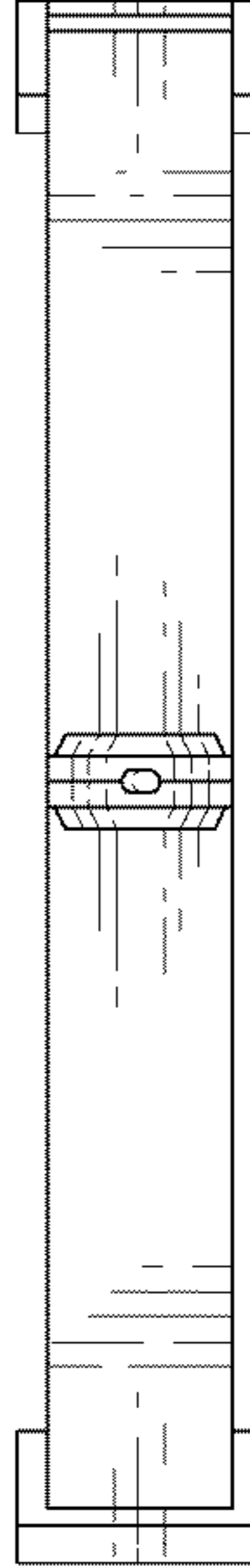

FIG. 6

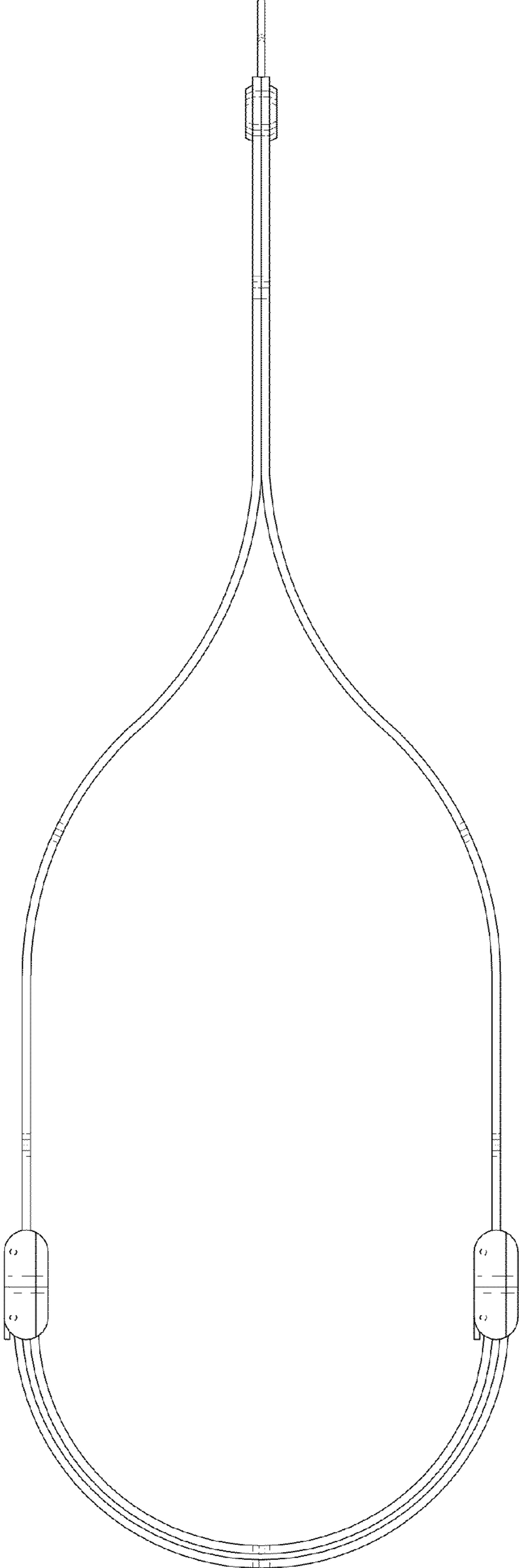

FIG. 7

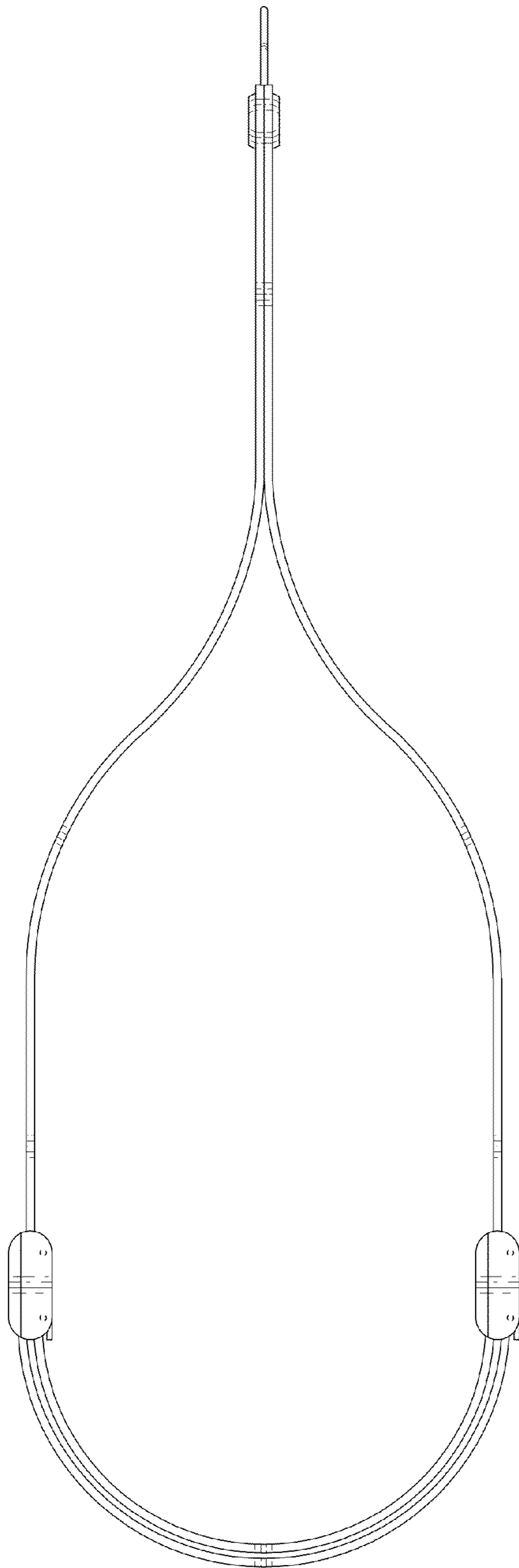
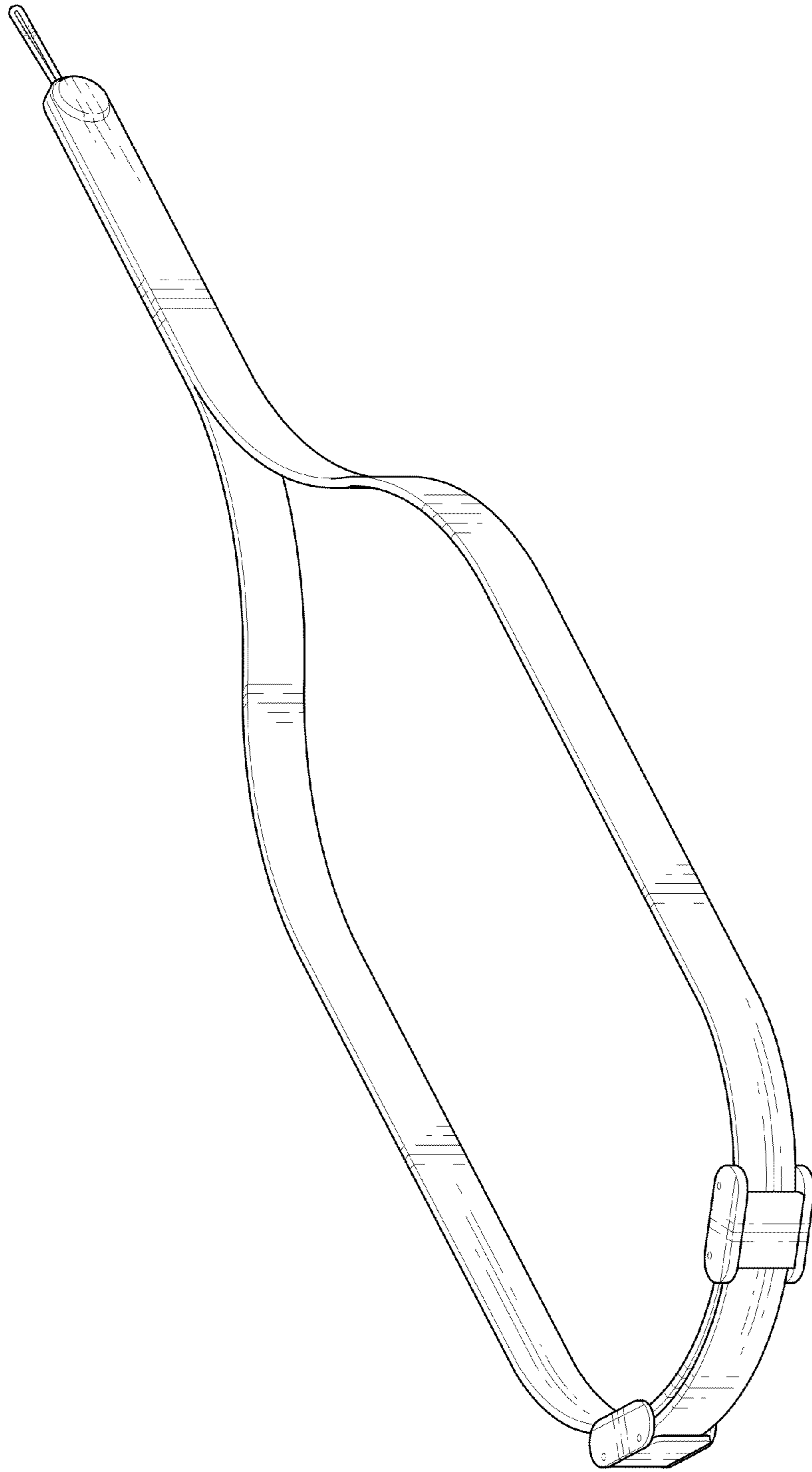

FIG. 8



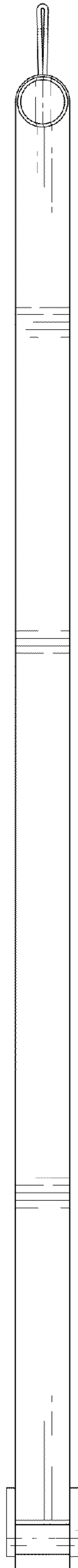

FIG. 9

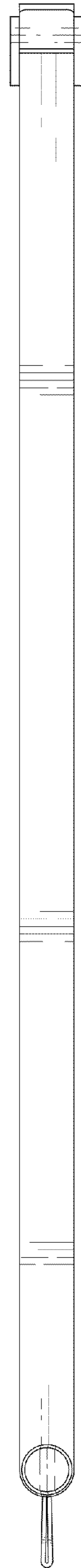

FIG. 10

FIG. 11

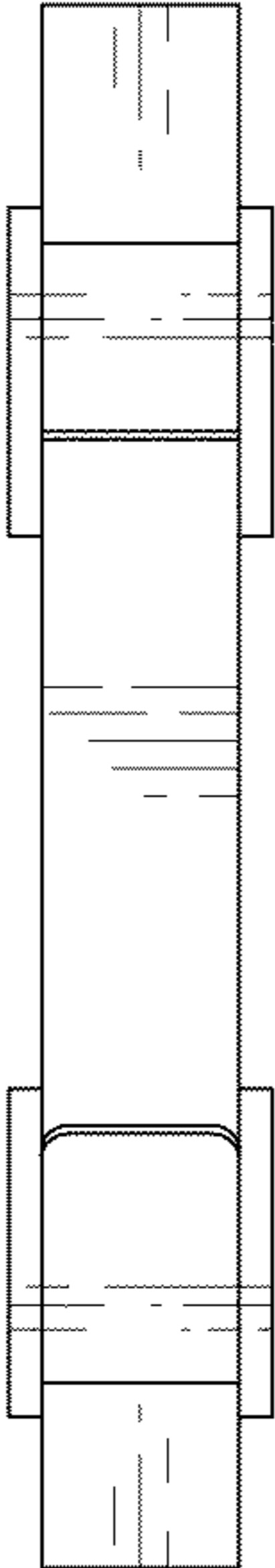

FIG. 12

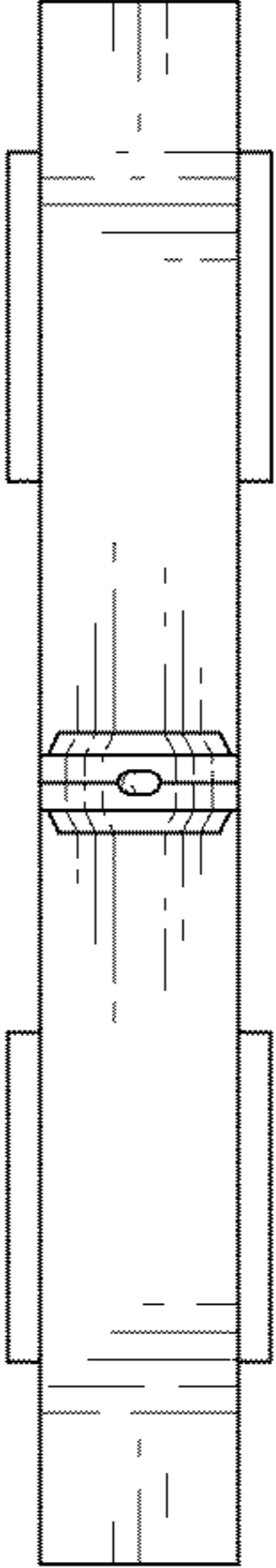

FIG. 13

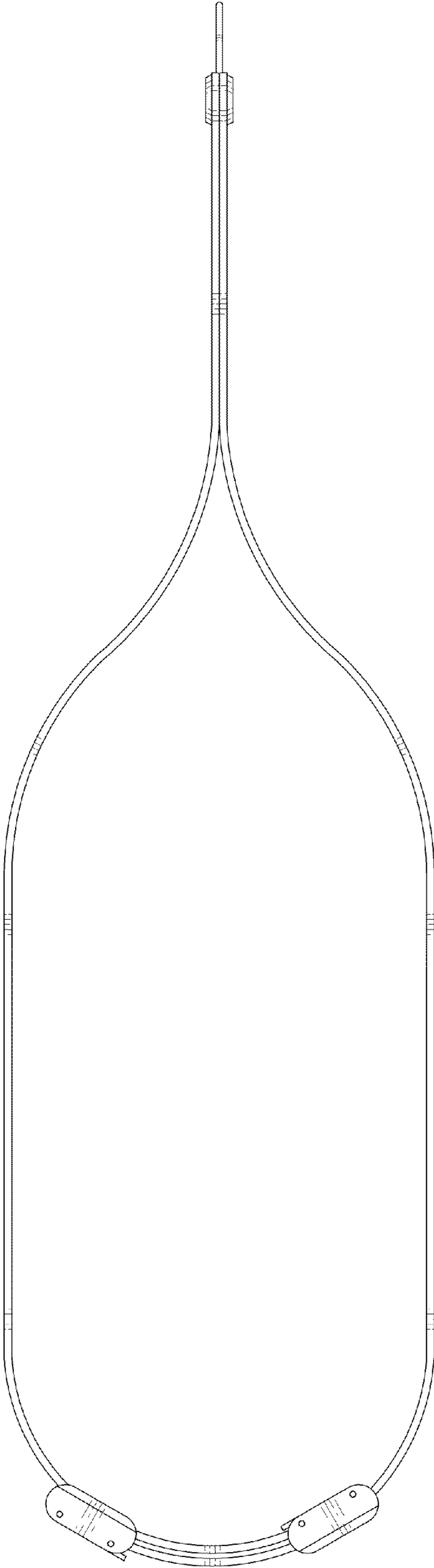

FIG. 14

