



US00D691575S

(12) **United States Design Patent**
Park

(10) **Patent No.:** **US D691,575 S**

(45) **Date of Patent:** **** Oct. 15, 2013**

(54) **MOBILE TERMINAL**

(75) Inventor: **Jun-Sang Park**, Anyang-si (KR)

(73) Assignee: **Samsung Electronics Co., Ltd.**,
Suwon-si (KR)

(**) Term: **14 Years**

(21) Appl. No.: **29/416,562**

(22) Filed: **Mar. 23, 2012**

(30) **Foreign Application Priority Data**

Oct. 14, 2011 (KR) 30-2011-0042807

(51) **LOC (9) Cl.** **14-03**

(52) **U.S. Cl.**
USPC **D14/138 AD; D14/346**

(58) **Field of Classification Search**
USPC D14/138 G, 138 AD, 341, 346, 138 R,
D14/138 AC, 496, 203.1, 203.4, 203.7, 248,
D14/218; 455/575.1, 556.2, 575.3, 575.4;
D21/517; 379/433.01, 433.04; D10/65,
D10/78, 104; D13/168

See application file for complete search history.

(56) **References Cited**

U.S. PATENT DOCUMENTS

D578,526 S * 10/2008 Hwangbo D14/341
D590,822 S * 4/2009 Leith et al. D14/248
D615,059 S * 5/2010 Price et al. D14/138 G
D617,793 S * 6/2010 Chiang et al. D14/341
D627,782 S * 11/2010 Ichise D14/346
D631,469 S * 1/2011 Demskie et al. D14/218
7,925,310 B2 * 4/2011 Chiu 455/575.1

D640,578 S * 6/2011 Aihara et al. D10/65
D645,833 S * 9/2011 Seflic et al. D14/138 G
D657,331 S * 4/2012 Jung D14/138 G

(Continued)

OTHER PUBLICATIONS

HTC HD7 telephone, announced Oct. 2010, [online], [site visited May 3, 2013]. Available from Internet, <URL: http://www.gsmarena.com/htc_hd7-3338.php>.*

(Continued)

Primary Examiner — Jeffrey D Asch
(74) *Attorney, Agent, or Firm* — NSIP Law

(57) **CLAIM**

The ornamental design for a mobile terminal, as shown and described.

DESCRIPTION

FIG. 1 is a perspective view of a mobile terminal;
FIG. 2 is a front view of the mobile terminal of FIG. 1;
FIG. 3 is a rear view of the mobile terminal of FIG. 1;
FIG. 4 is a left-side view of the mobile terminal of FIG. 1;
FIG. 5 is a right-side view of the mobile terminal of FIG. 1;
FIG. 6 is a top plan view of the mobile terminal of FIG. 1;
FIG. 7 is a bottom plan view of the mobile terminal of FIG. 1;
FIG. 8 is a perspective view of the mobile terminal of FIG. 1 in which an open slide-out position of the mobile terminal is illustrated to further show an ornamental aspect of my claimed design;
FIG. 9 is a perspective view of the rear of the mobile terminal of FIG. 1; and,
FIG. 10 is a perspective view of the rear of the mobile terminal of FIG. 1 in which an upright position of a cover of the mobile phone is illustrated to still further show an ornamental aspect of my claimed design.

The broken lines shown in the figures that are immediately adjacent to the shaded areas and define regions that are consistently unshaded represent the bounds of the claim; the broken lines form no part of the claimed design.

1 Claim, 8 Drawing Sheets

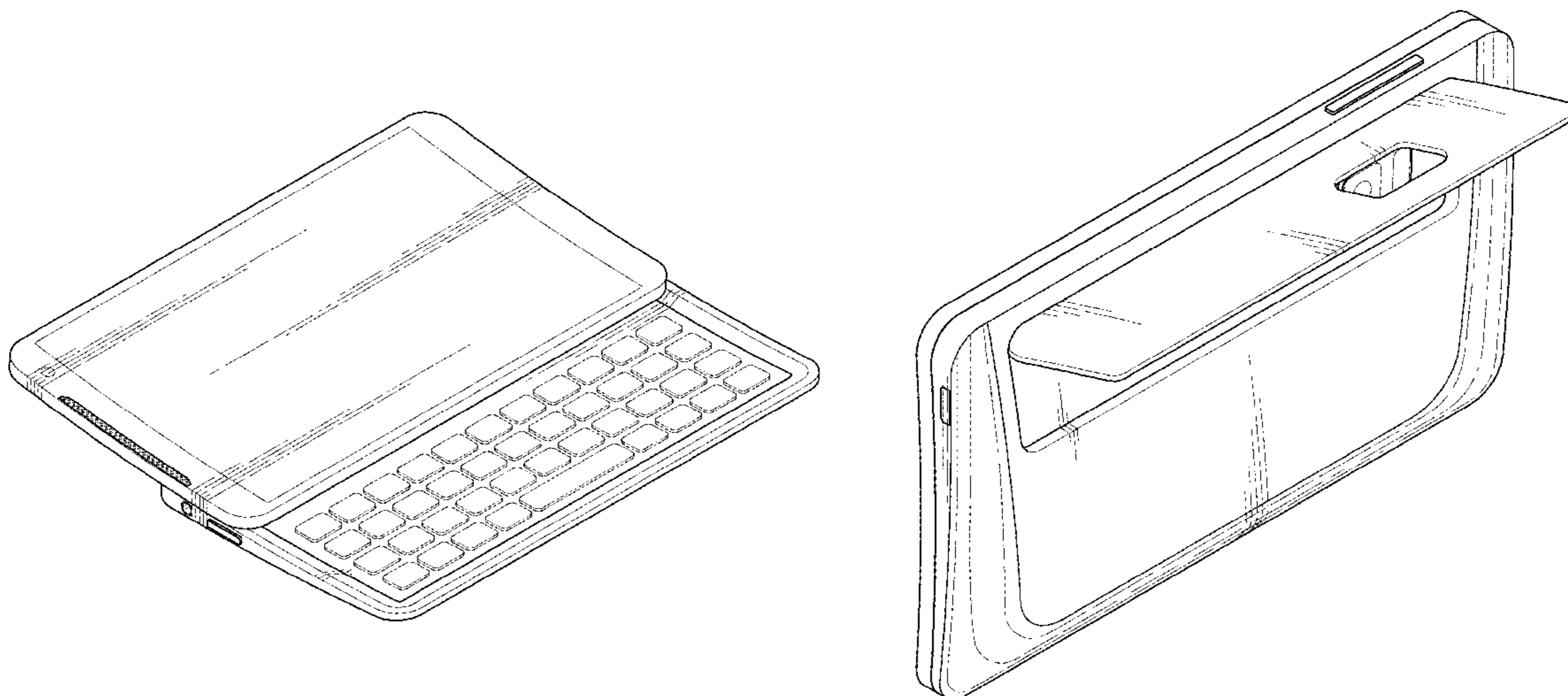

(56)

References Cited

U.S. PATENT DOCUMENTS

D657,332 S * 4/2012 Veiga et al. D14/138 G
D658,147 S * 4/2012 Yoon D14/138 G
D659,664 S * 5/2012 Park et al. D14/138 AD
D659,692 S * 5/2012 Jung et al. D14/341
D663,280 S * 7/2012 Lee D14/138 AD
D663,709 S * 7/2012 Kim et al. D14/138 AD
D665,370 S * 8/2012 Chung D14/138 AD
D669,070 S * 10/2012 Hsu et al. D14/341
D669,469 S * 10/2012 Kang D14/341
D677,640 S * 3/2013 Kim et al. D14/138 G
D678,877 S * 3/2013 Groene et al. D14/341

D681,580 S * 5/2013 Park D14/138 G
D681,582 S * 5/2013 Park D14/138 G
2011/0117977 A1* 5/2011 Yamashita et al. 455/575.4
2013/0017866 A1* 1/2013 Park et al. 455/566

OTHER PUBLICATIONS

HTC ThunderBolt 4G telephone, announced Jan. 2011, [online], [site visited May 3, 2013]. Available from Internet, <URL: http://www.gsmarena.com/htc_thunderbolt_4g-3703.php>.*
Huawei IDEOS S7 telephone, announced Jan. 2010, [online], [site visited May 3, 2013]. Available from Internet, <URL: http://www.gsmarena.com/huawei_ideos_s7-3740.php>.*

* cited by examiner

FIG. 1

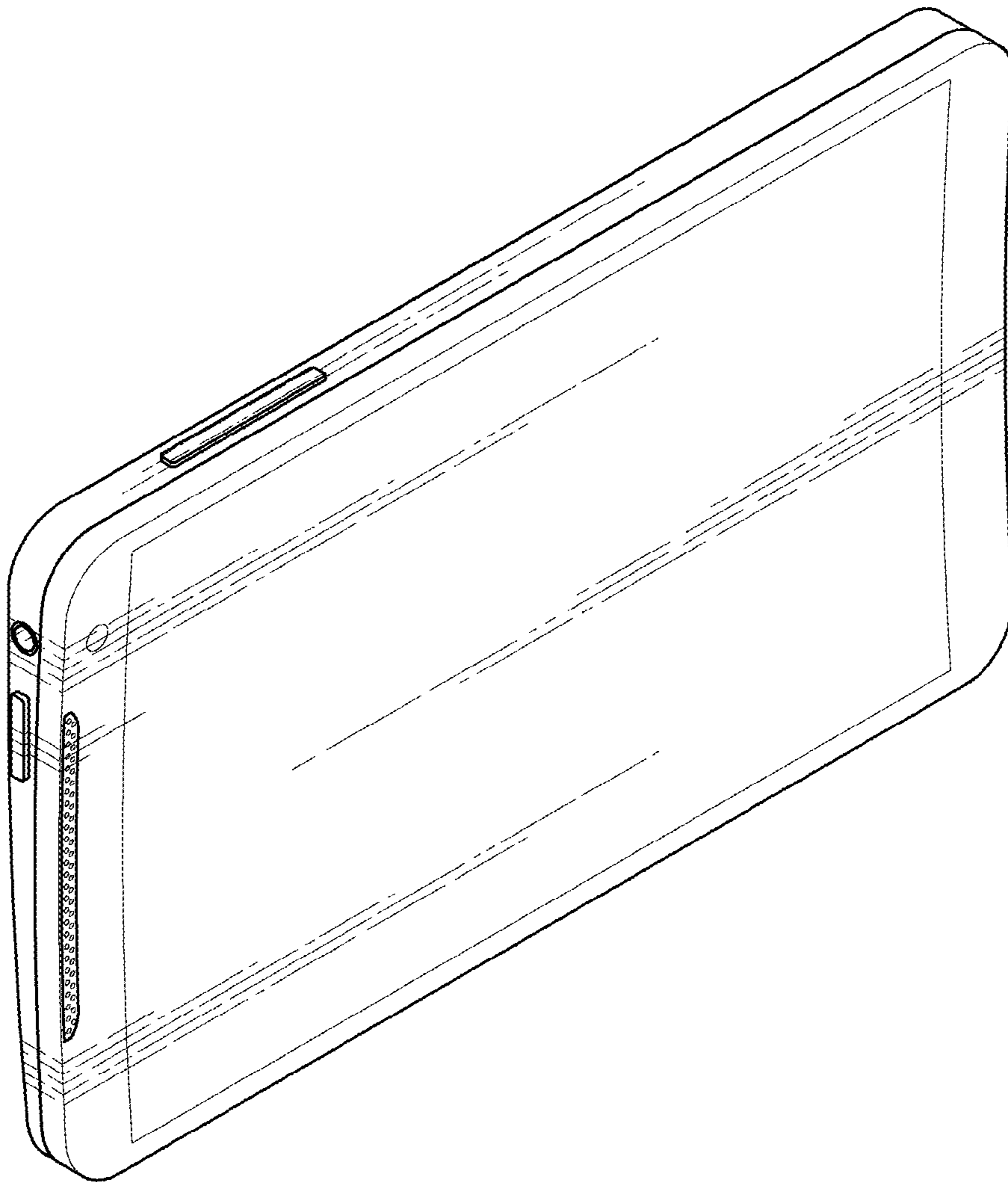

FIG. 2

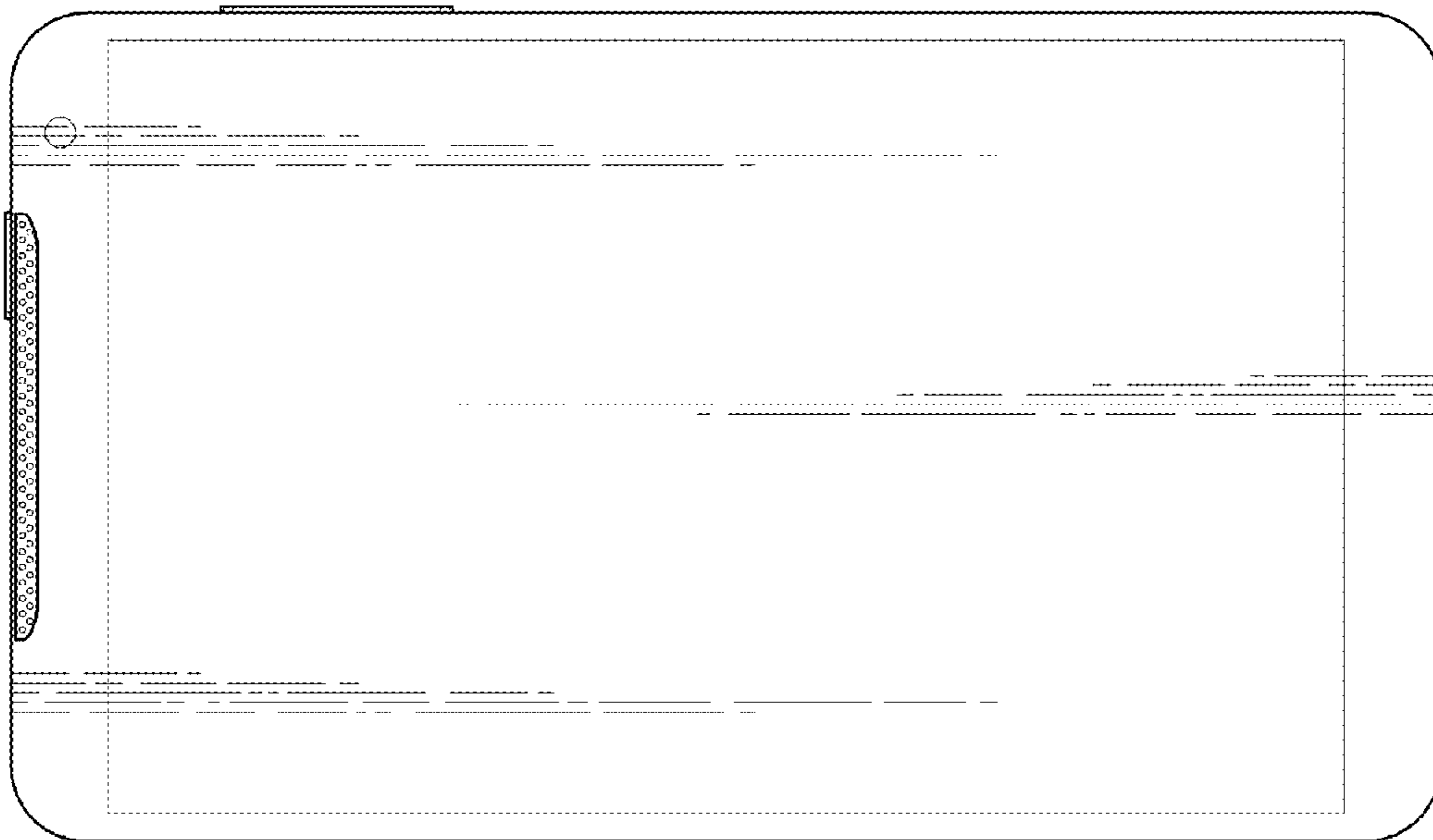

FIG. 3

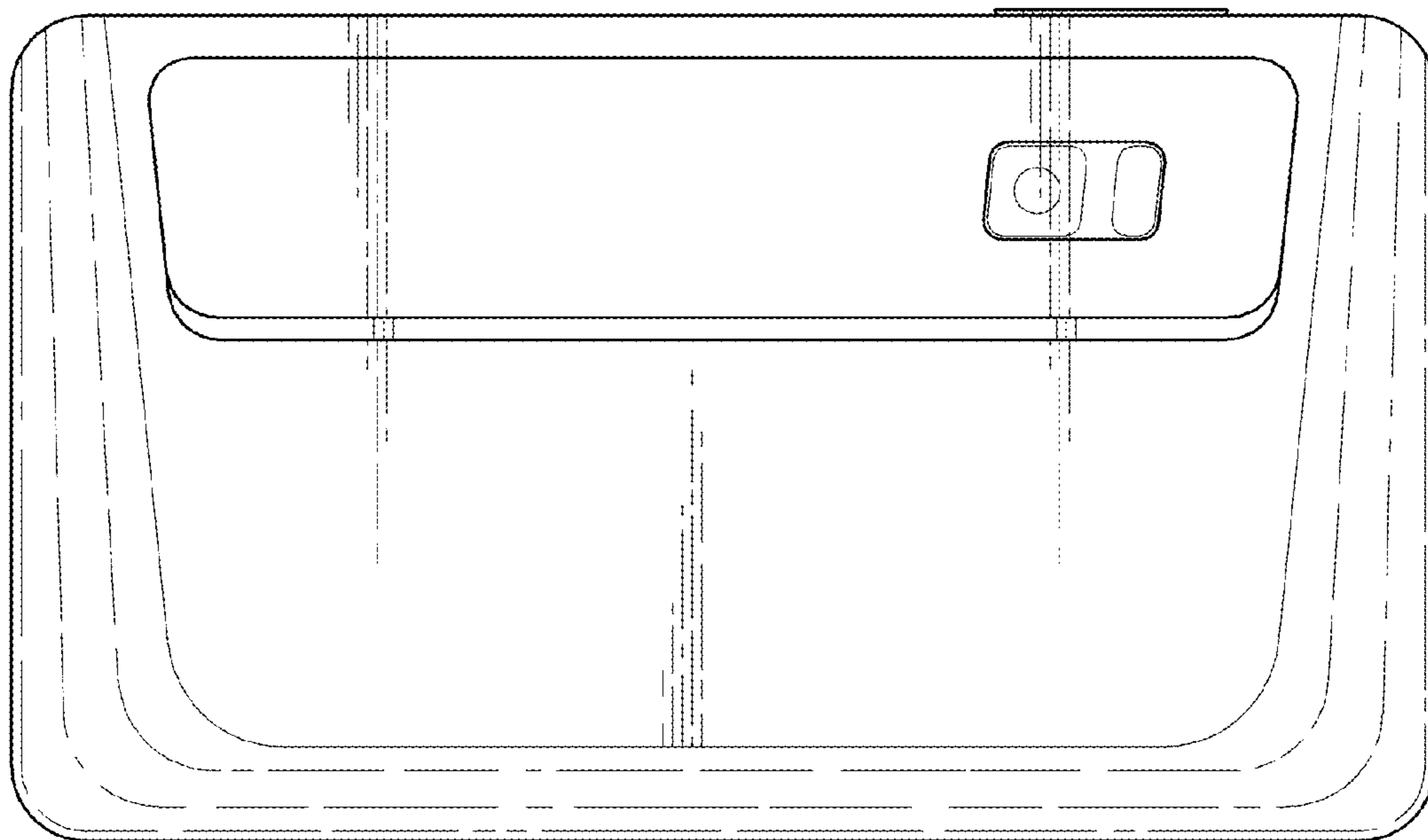

FIG. 4

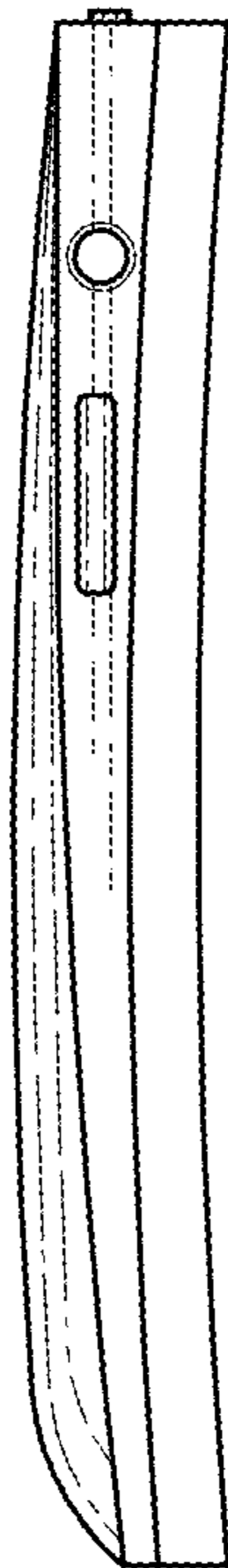

FIG. 5

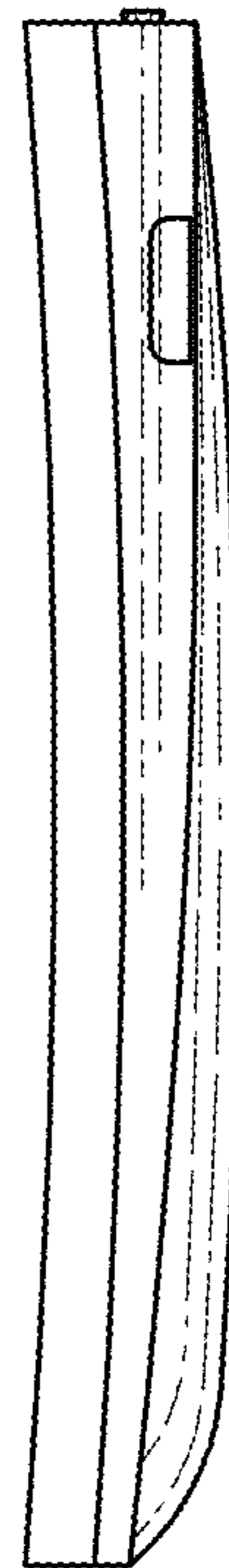

FIG. 6

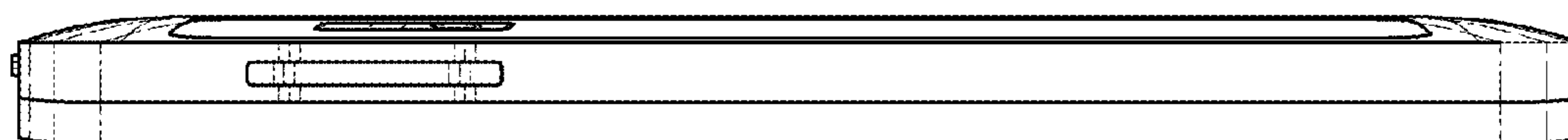

FIG. 7

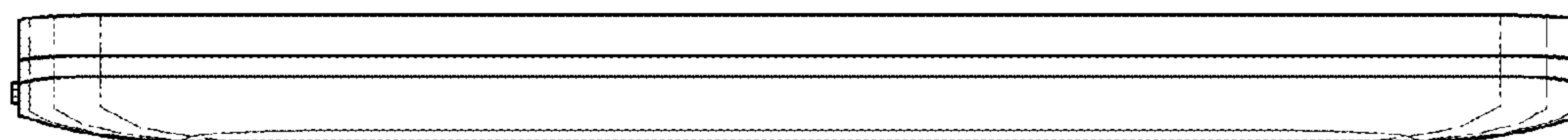

FIG. 8

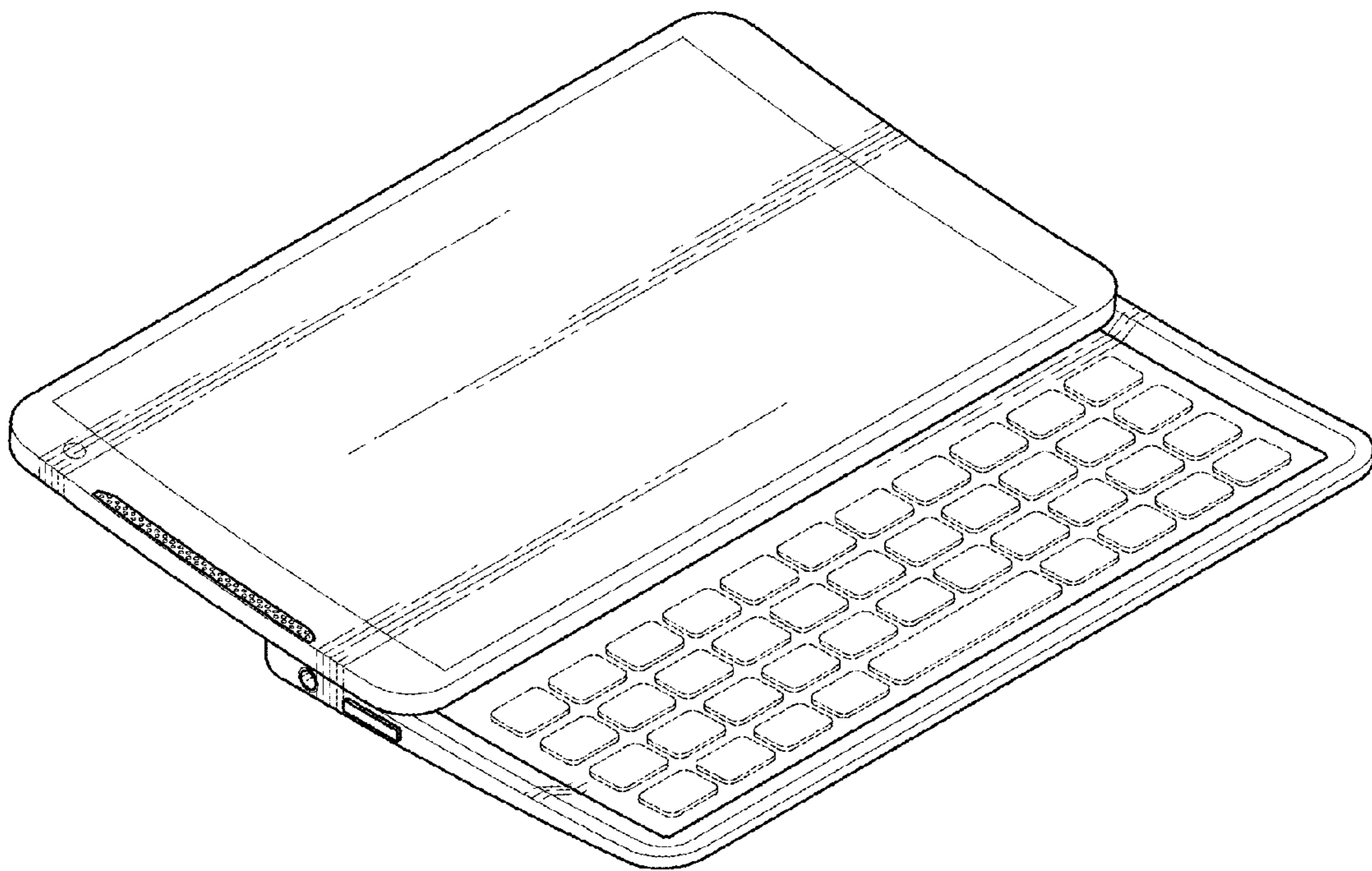

FIG. 9

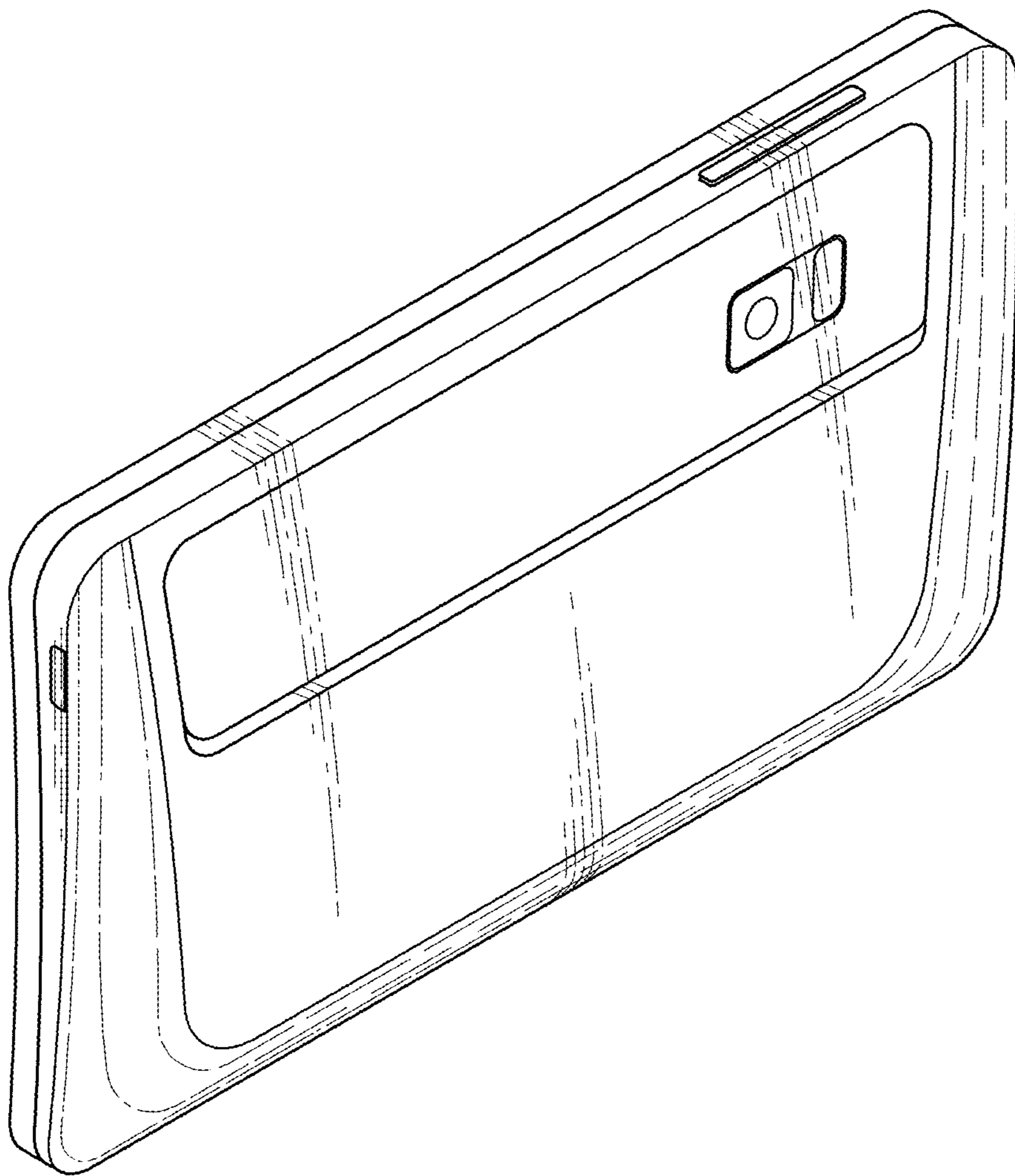

FIG. 10

