

US00D691555S

(12) **United States Design Patent**  
**Esses**

(10) **Patent No.:** **US D691,555 S**  
(45) **Date of Patent:** **\*\* Oct. 15, 2013**

(54) **CHARGING SYSTEM**

(71) Applicant: **Premier Accessory Group LLC**,  
Edison, NJ (US)

(72) Inventor: **Alfred Esses**, Brooklyn, NY (US)

(73) Assignee: **Premier Accessory Group LLC**,  
Edison, NJ (US)

(\*\*) Term: **14 Years**

(21) Appl. No.: **29/449,795**

(22) Filed: **Mar. 15, 2013**

(51) **LOC (9) Cl.** ..... **13-02**

(52) **U.S. Cl.**  
USPC ..... **D13/110**

(58) **Field of Classification Search**  
USPC ..... D13/110, 103, 107, 108, 118, 119,  
D13/123, 133, 137.1, 184, 199; D14/240,  
D14/251, 356, 432, 433, 434; 174/53, 54,  
174/59, 61; 307/11, 150, 151; 320/107,  
320/111, 112, 113, 114, 115; 361/679.01;  
363/142, 146; 439/131, 172, 626, 628, 638  
See application file for complete search history.

(56) **References Cited**

U.S. PATENT DOCUMENTS

D412,487 S \* 8/1999 Nagele et al. .... D13/108  
D425,017 S \* 5/2000 Leung ..... D13/110  
D436,918 S \* 1/2001 Matsuda ..... D13/110  
D470,826 S \* 2/2003 Bergmann ..... D13/184

D540,742 S \* 4/2007 Bell ..... D13/107  
D544,834 S \* 6/2007 Weinstein ..... D13/110  
D552,081 S \* 10/2007 Yano ..... D14/214  
D553,564 S \* 10/2007 Kuo ..... D13/110  
D568,814 S \* 5/2008 Hung ..... D13/123  
D582,846 S \* 12/2008 Lett ..... D13/110  
D615,033 S \* 5/2010 Baker et al. .... D13/107  
D615,492 S \* 5/2010 Mibayashi ..... D13/110  
D618,167 S \* 6/2010 Tiffe ..... D13/103  
D654,867 S \* 2/2012 Huppe ..... D13/110

\* cited by examiner

*Primary Examiner* — Derrick Holland

(74) *Attorney, Agent, or Firm* — Gottlieb, Rackman & Reisman, P.C.

(57) **CLAIM**

The ornamental design for a charging system, as shown and described.

**DESCRIPTION**

FIG. 1 is a bottom, front, left side perspective view of a charging system having the design of my invention;  
FIG. 2 is a top plan view thereof;  
FIG. 3 is a front elevation view thereof;  
FIG. 4 is a left side elevation view thereof;  
FIG. 5 is a right side elevation view thereof;  
FIG. 6 is a rear elevation view thereof;  
FIG. 7 is a bottom plan view thereof; and,  
FIG. 8 is another bottom, front, left side perspective view thereof.

The broken lines shown represent unclaimed subject matter and form no part of the claimed design.

**1 Claim, 4 Drawing Sheets**

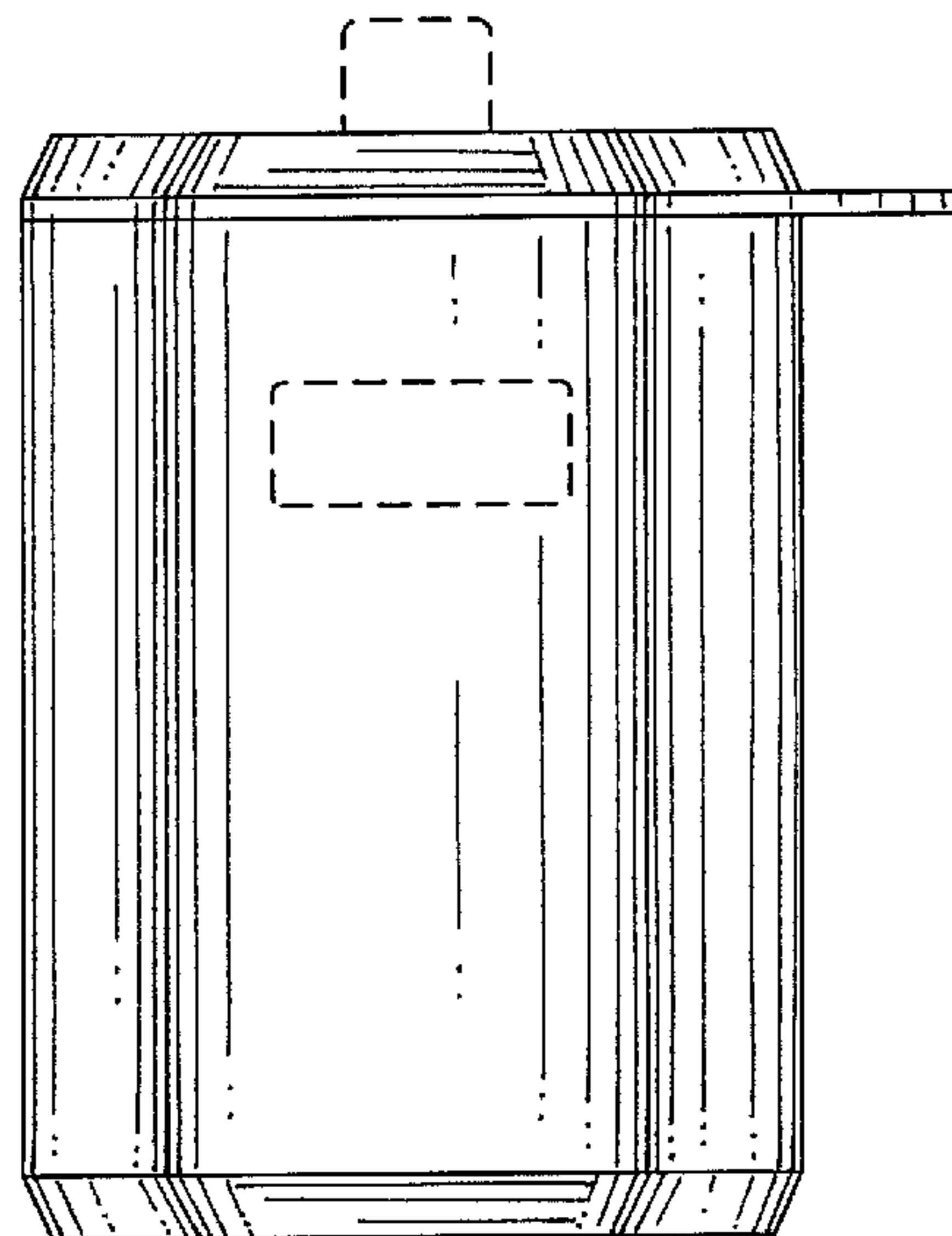
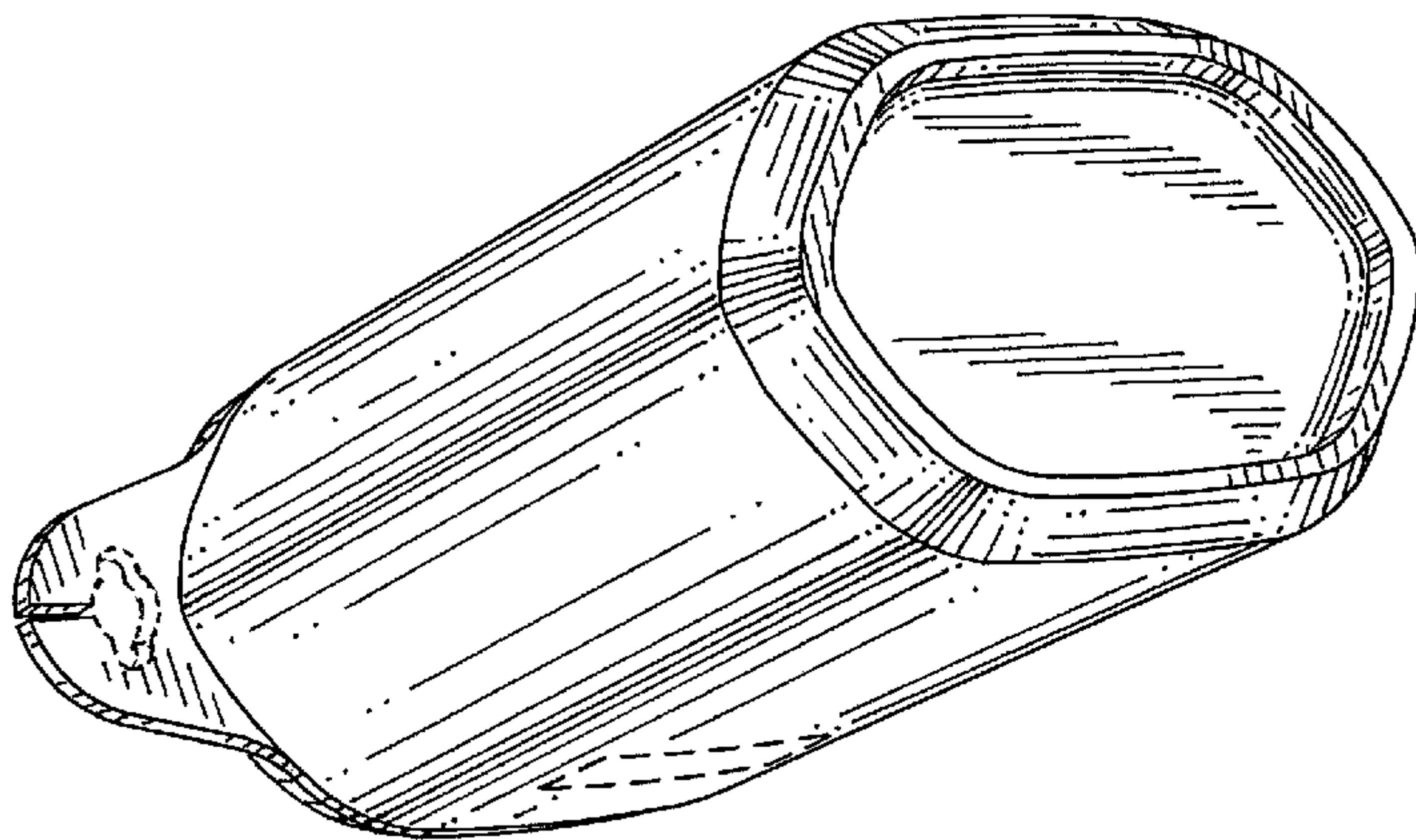

FIG. 1

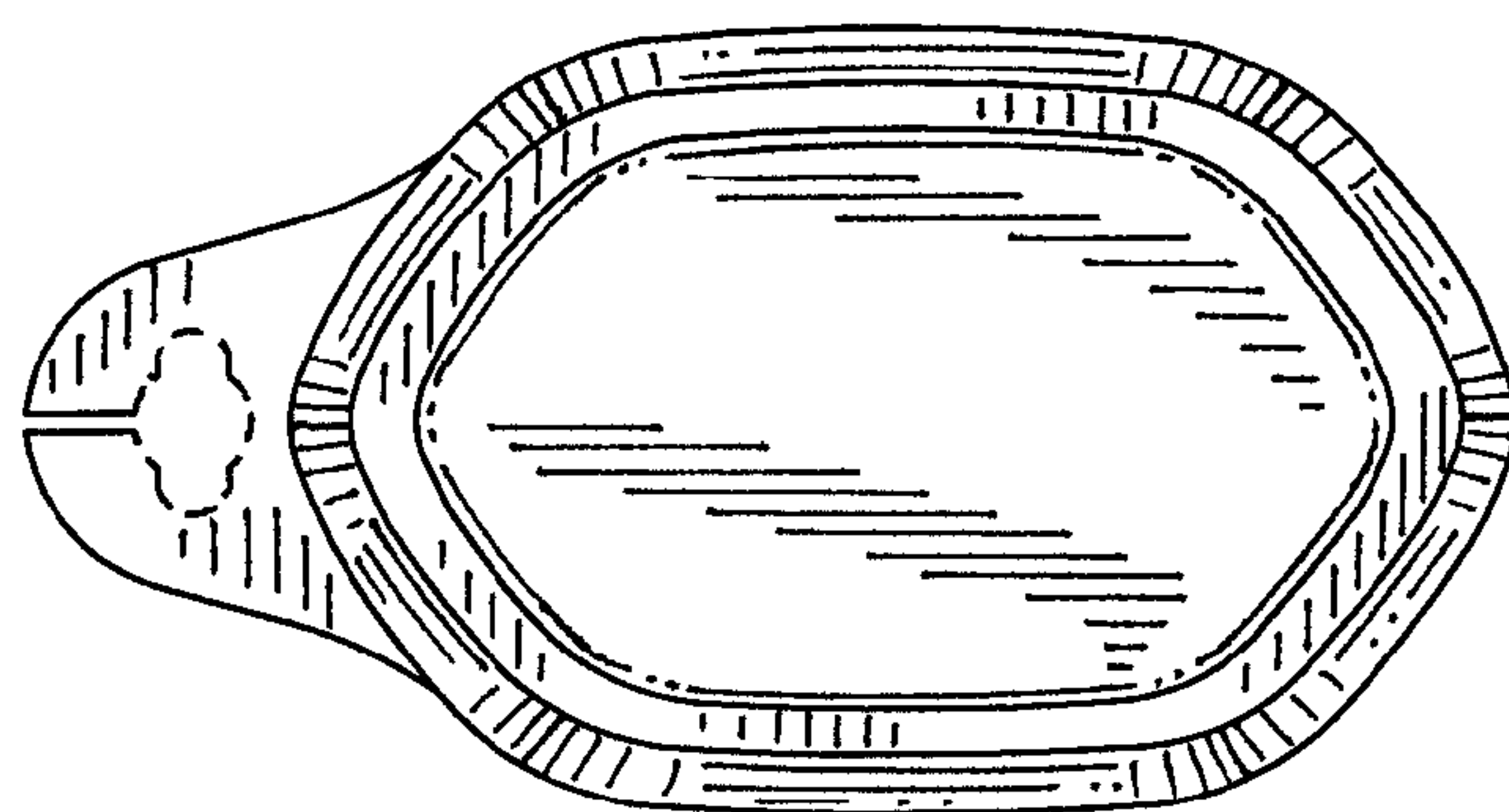
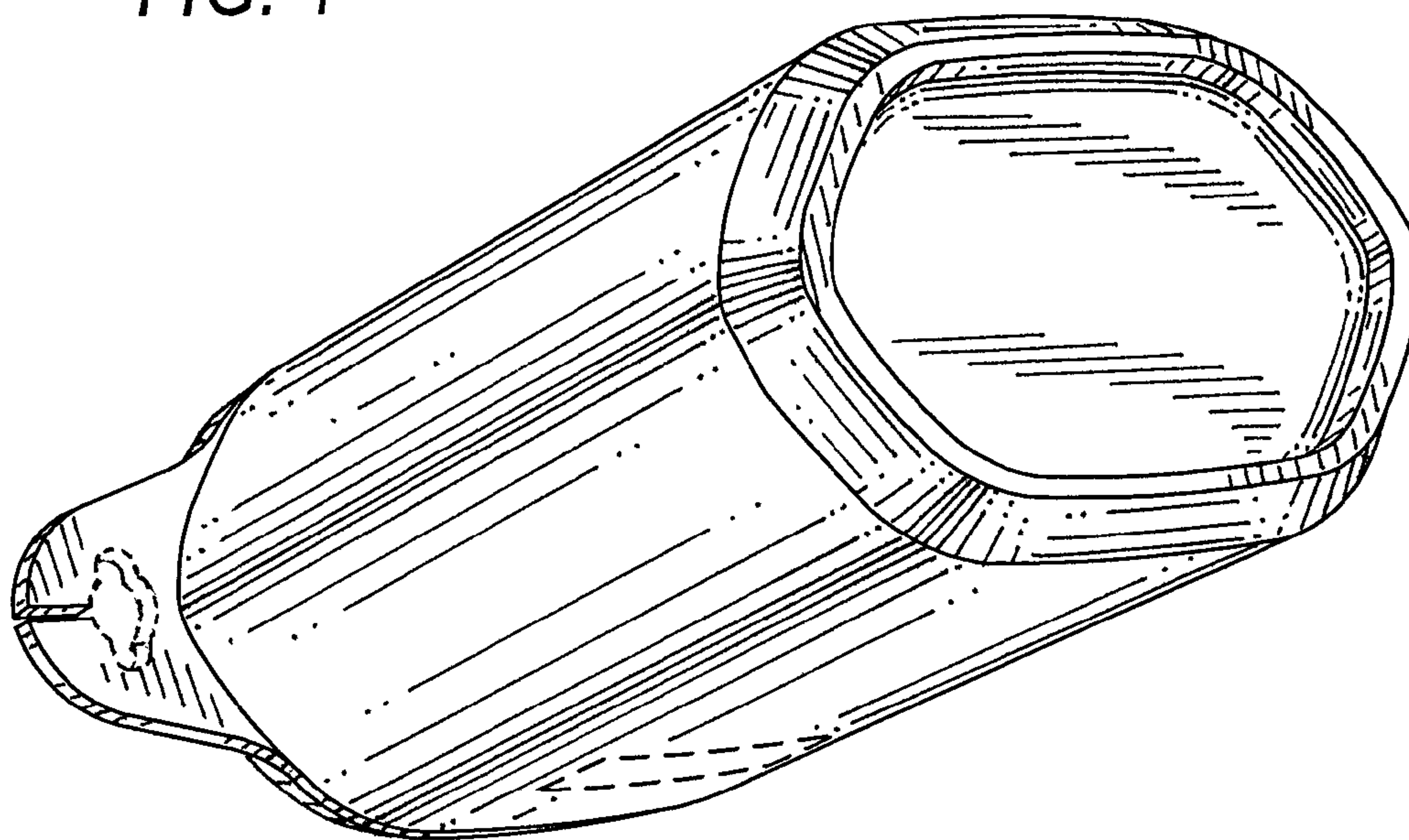

FIG. 3

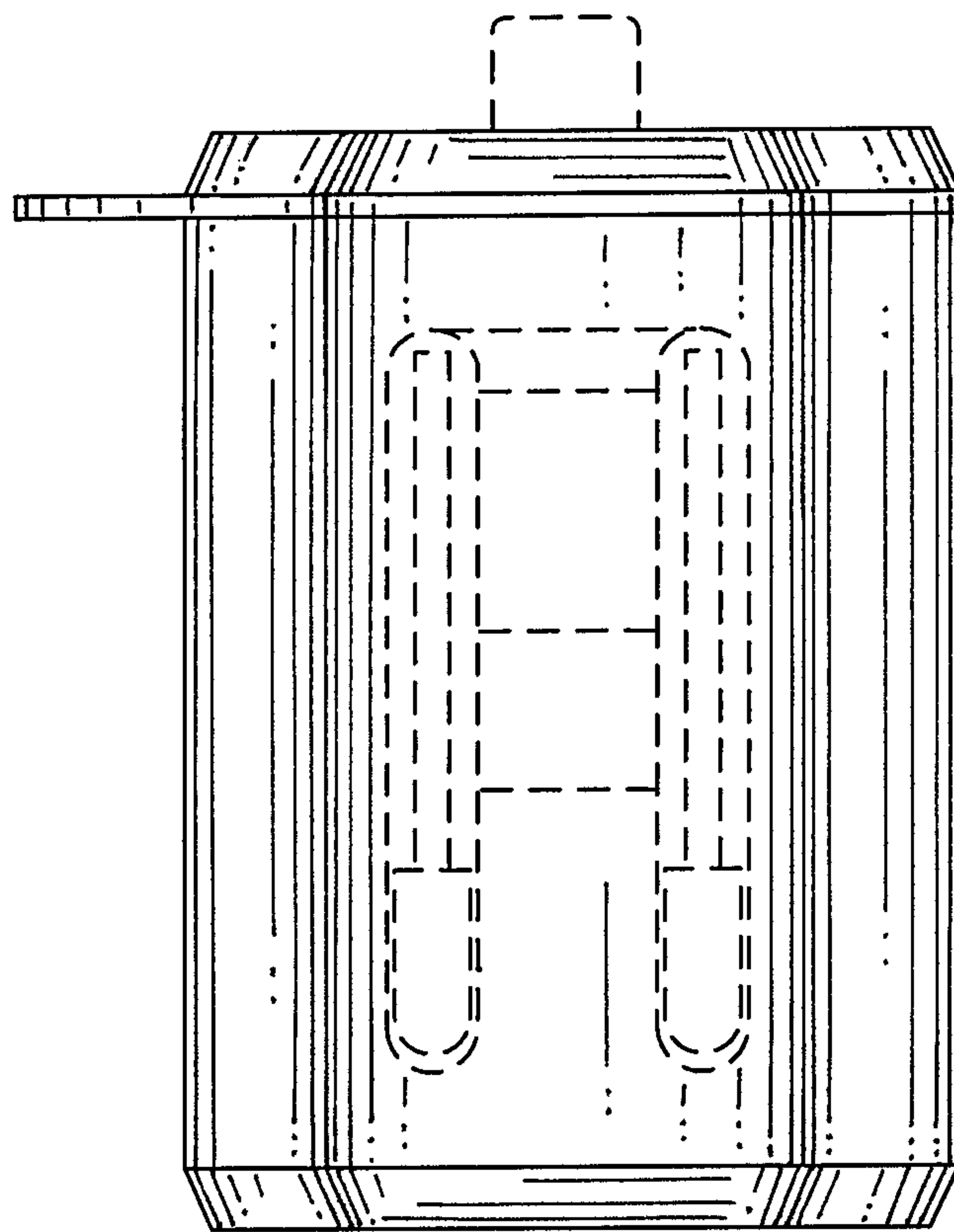

FIG. 2

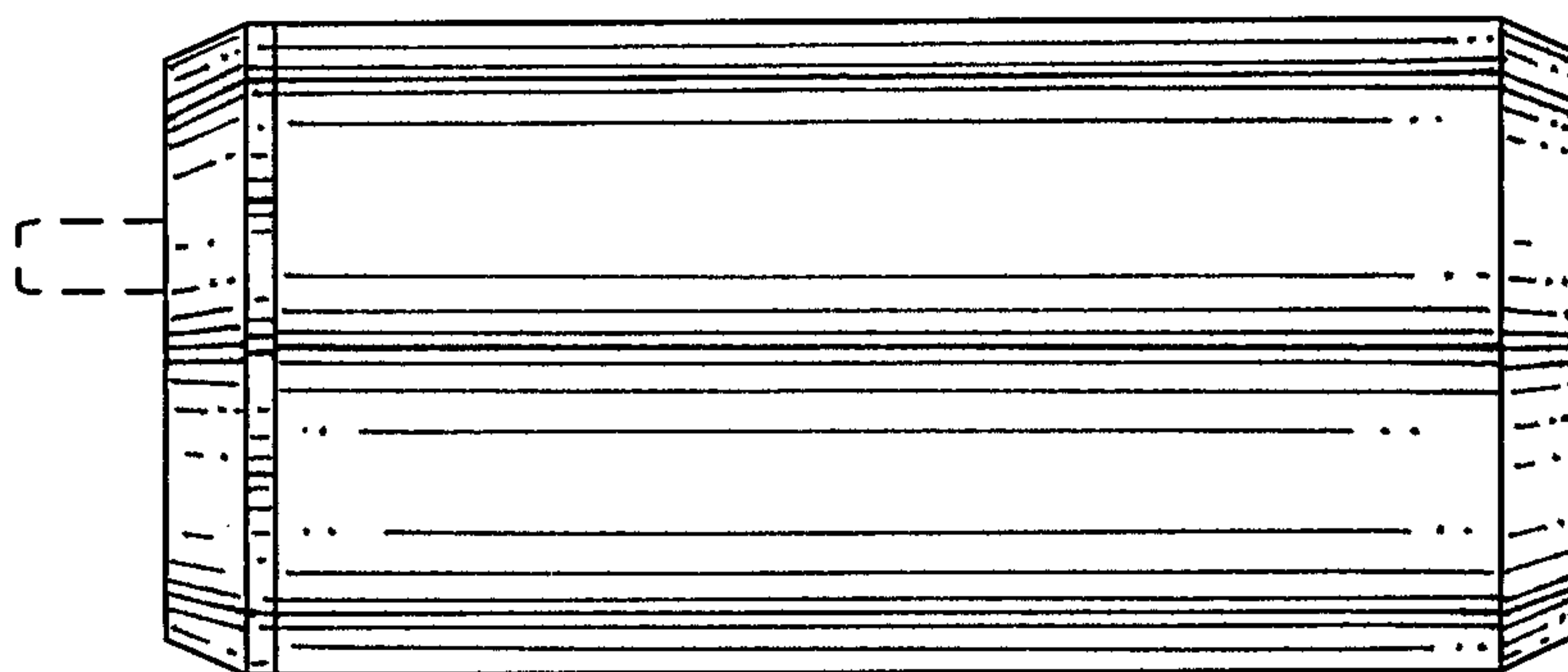

FIG. 4

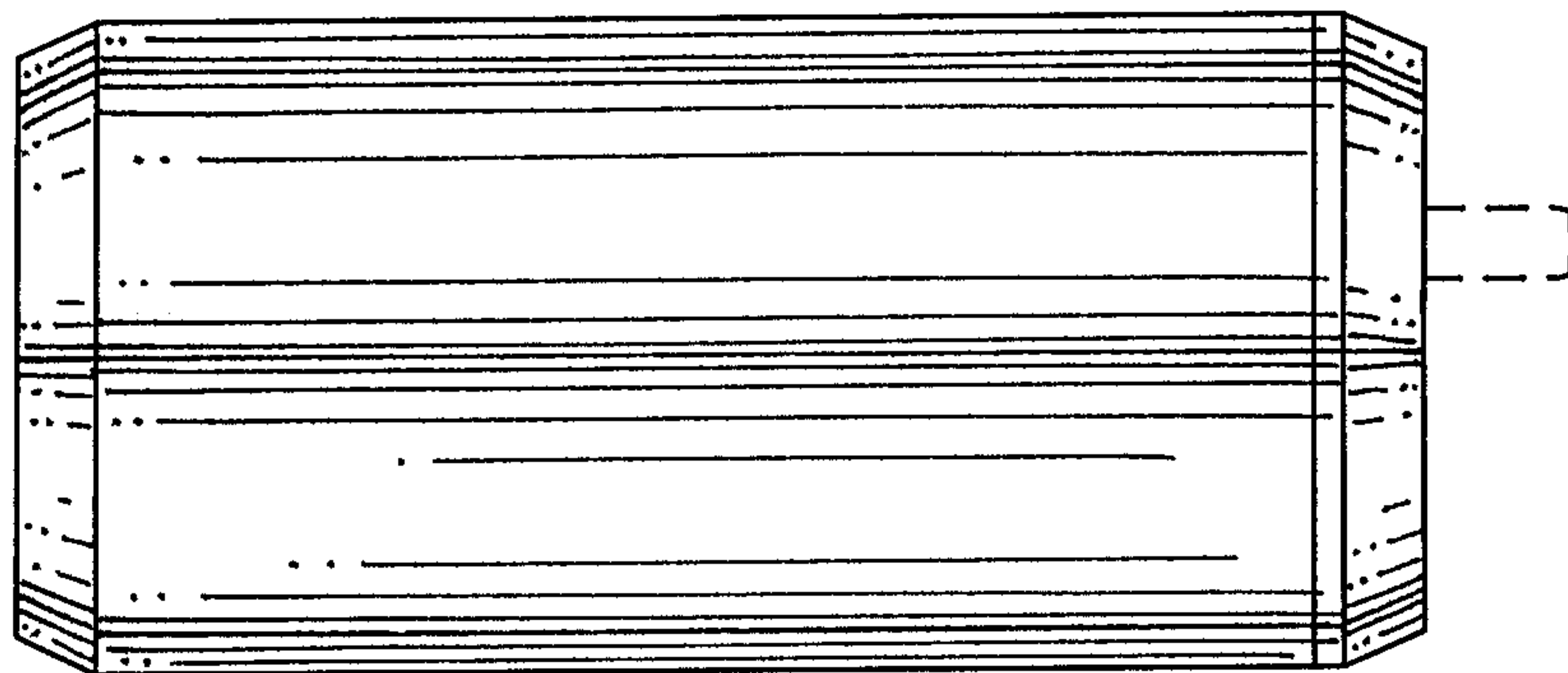

FIG. 5

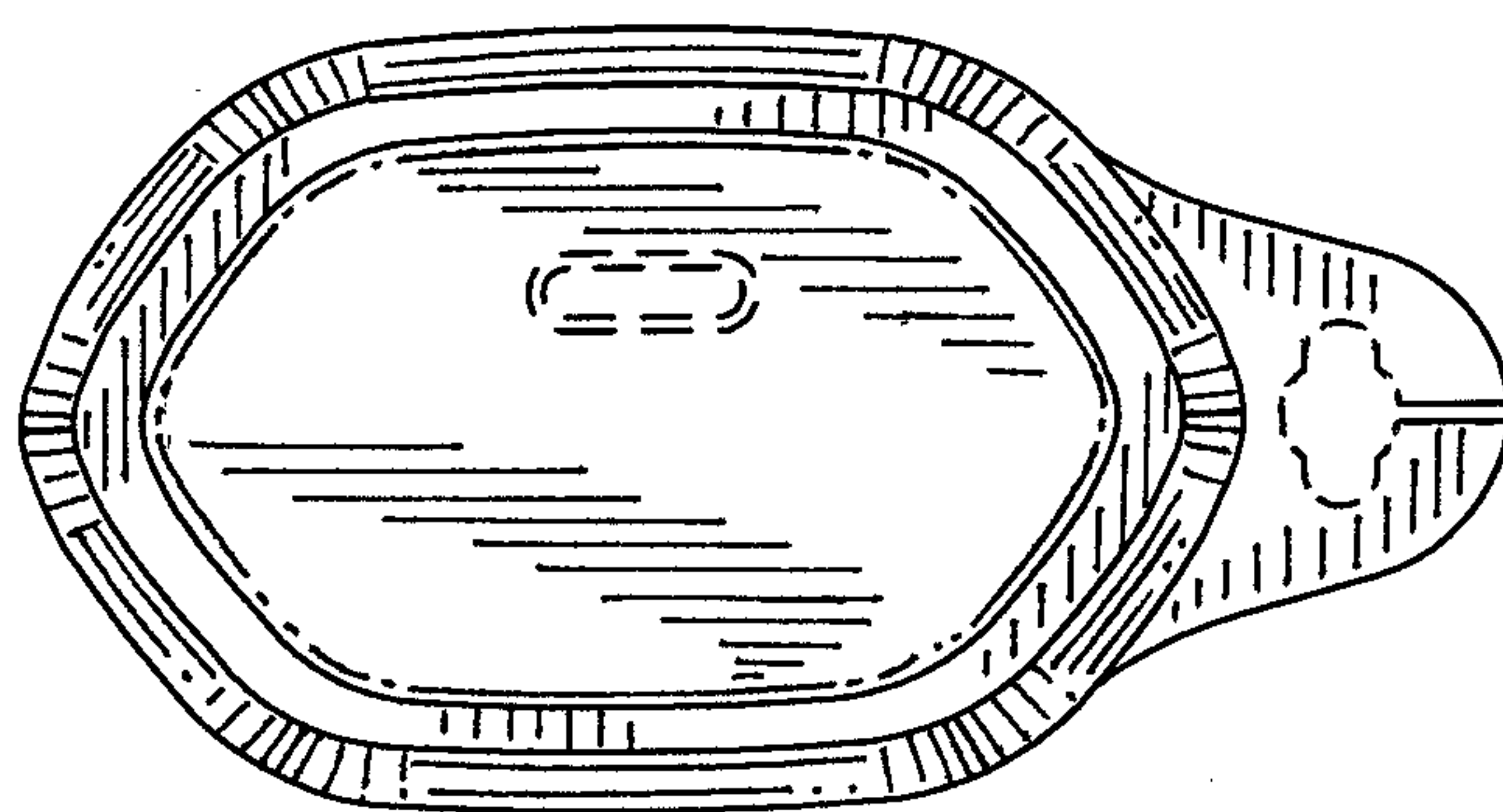

FIG. 6



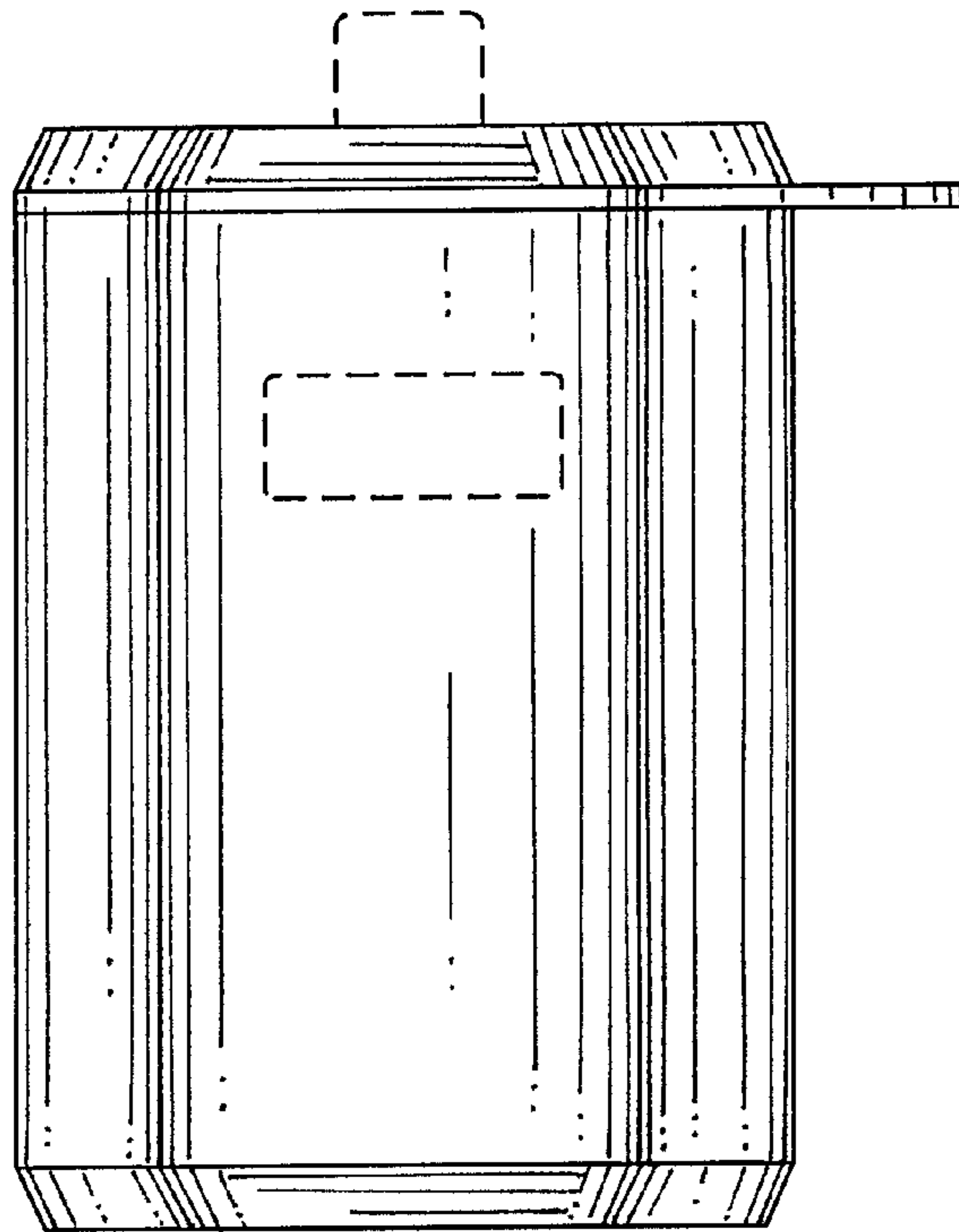

FIG. 7

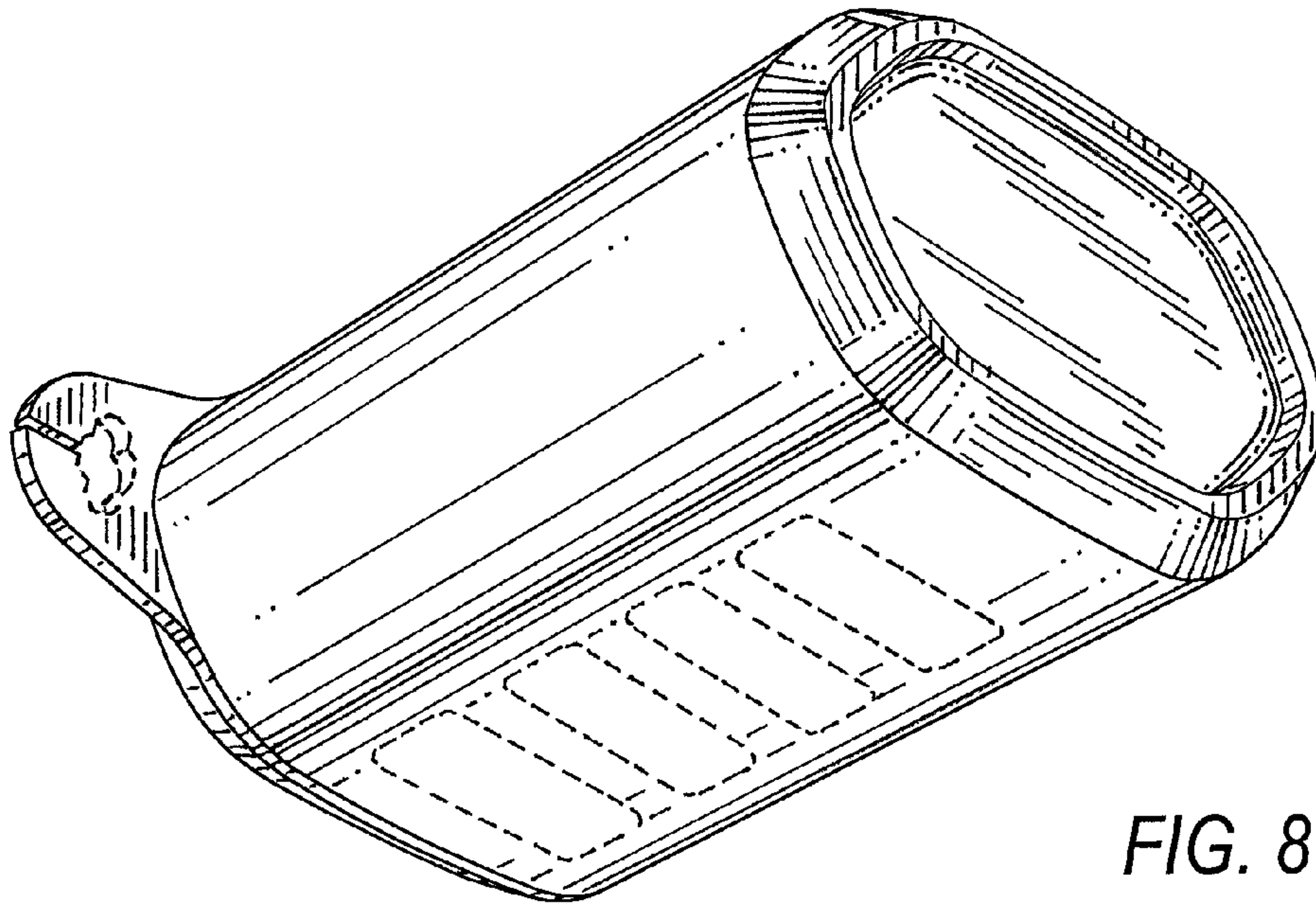

FIG. 8