

US00D691495S

(12) **United States Design Patent**
Duport

(10) **Patent No.:** **US D691,495 S**
(45) **Date of Patent:** **** Oct. 15, 2013**

(54) **WRISTWATCH**

(75) Inventor: **Fabrice Duport**, Neuchâtel (CH)

(73) Assignee: **Rado Uhren AG (Rado Watch Co. Ltd.) (Montres Rado SA)**, Lengnau (CH)

(**) Term: **14 Years**

(21) Appl. No.: **29/428,619**

(22) Filed: **Aug. 1, 2012**

(30) **Foreign Application Priority Data**

Feb. 10, 2012 (WO) DM/077 678

(51) **LOC (9) Cl.** **10-02**

(52) **U.S. Cl.**
USPC **D10/32**

(58) **Field of Classification Search**
USPC D10/30-39, 122-132; 368/276, 281,
368/282, 223, 228, 232, 80, 294, 295;
D11/3, 12
See application file for complete search history.

(56) **References Cited**

U.S. PATENT DOCUMENTS

- 2,361,563 A * 10/1944 Pellaton 368/80
- 2,385,234 A * 9/1945 Schmitz 368/288
- D401,866 S * 12/1998 Pandel D10/32
- D471,482 S * 3/2003 Calvani D11/3

- D521,395 S * 5/2006 Slimane D10/32
- D525,537 S * 7/2006 Monachon D10/32
- D538,182 S * 3/2007 Lalo D10/32
- D551,095 S * 9/2007 Monachon D10/32
- D574,733 S * 8/2008 Blair D10/32
- D584,171 S * 1/2009 Monachon D10/32
- D586,240 S * 2/2009 Reginelli D10/32
- D608,223 S * 1/2010 Salanitro D10/38
- D627,243 S * 11/2010 Deleskiewicz et al. D10/39
- D648,638 S * 11/2011 Monachon D10/39
- D659,025 S * 5/2012 Yurman D10/32
- D673,463 S * 1/2013 Duport D10/32

* cited by examiner

Primary Examiner — Lucy Lieberman

(74) *Attorney, Agent, or Firm* — Donald J. Ranft; Collen IP

(57) **CLAIM**

The ornamental design for a wristwatch, as shown and described.

DESCRIPTION

FIG. 1 is a front perspective view of a wristwatch showing my new design;
 FIG. 2 is a rear perspective view thereof;
 FIG. 3 is a right side view thereof;
 FIG. 4 is a left side view thereof;
 FIG. 5 is a bottom view thereof;
 FIG. 6 is a top view thereof;
 FIG. 7 is a front view thereof; and,
 FIG. 8 is a rear view thereof.

The portions of the wristwatch shown in broken lines form no part of the claimed design.

1 Claim, 6 Drawing Sheets

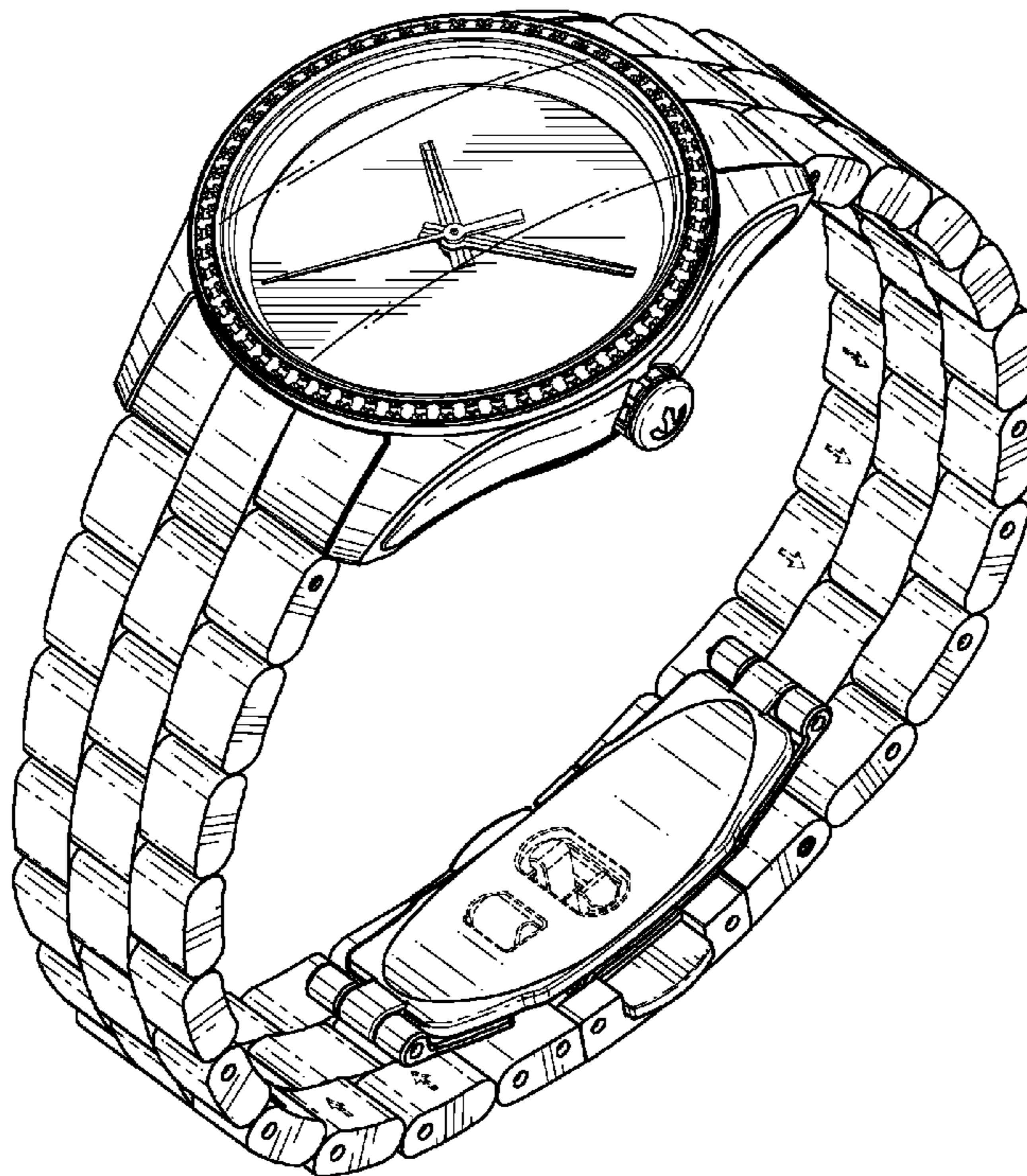

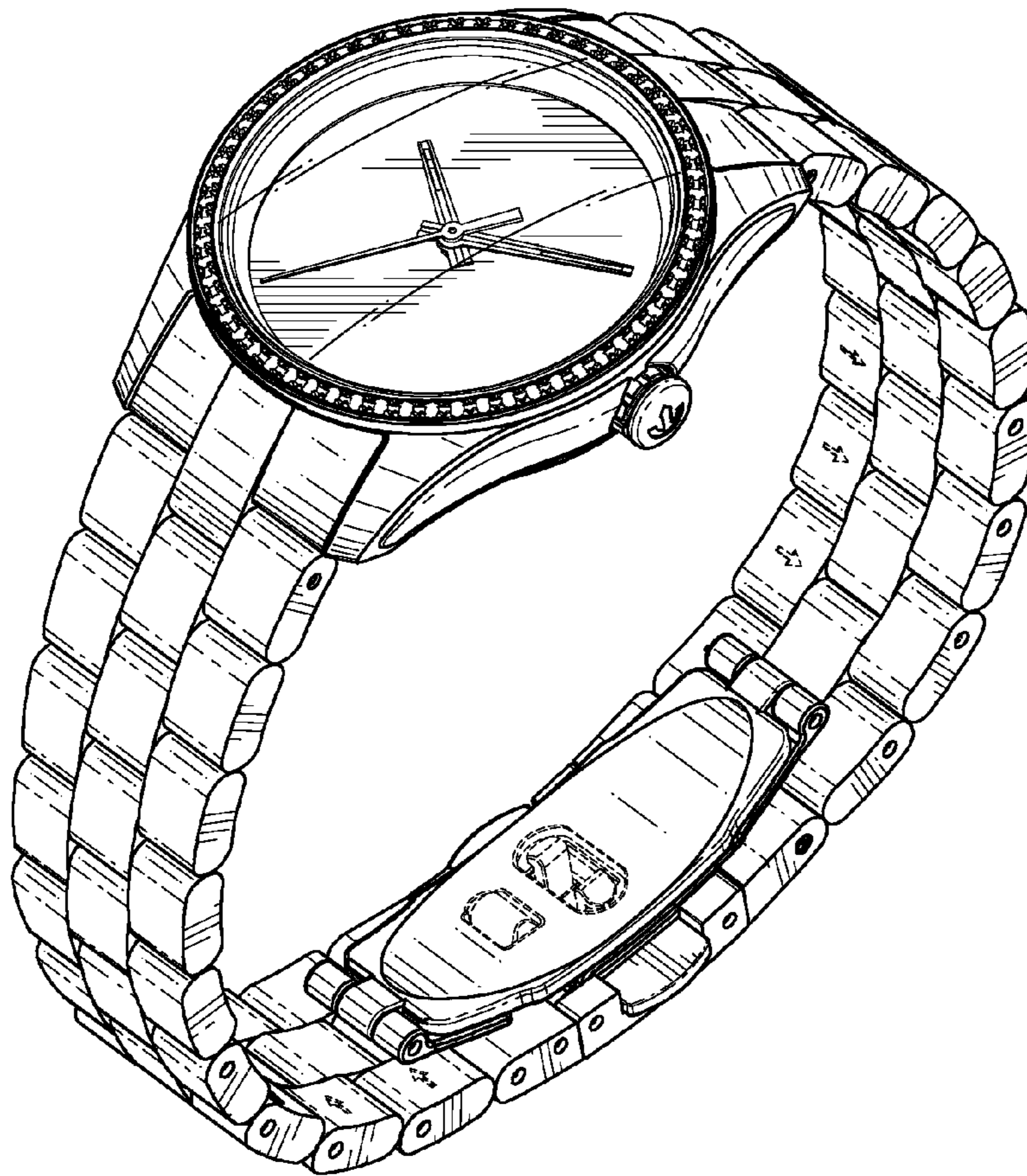

FIG. 1

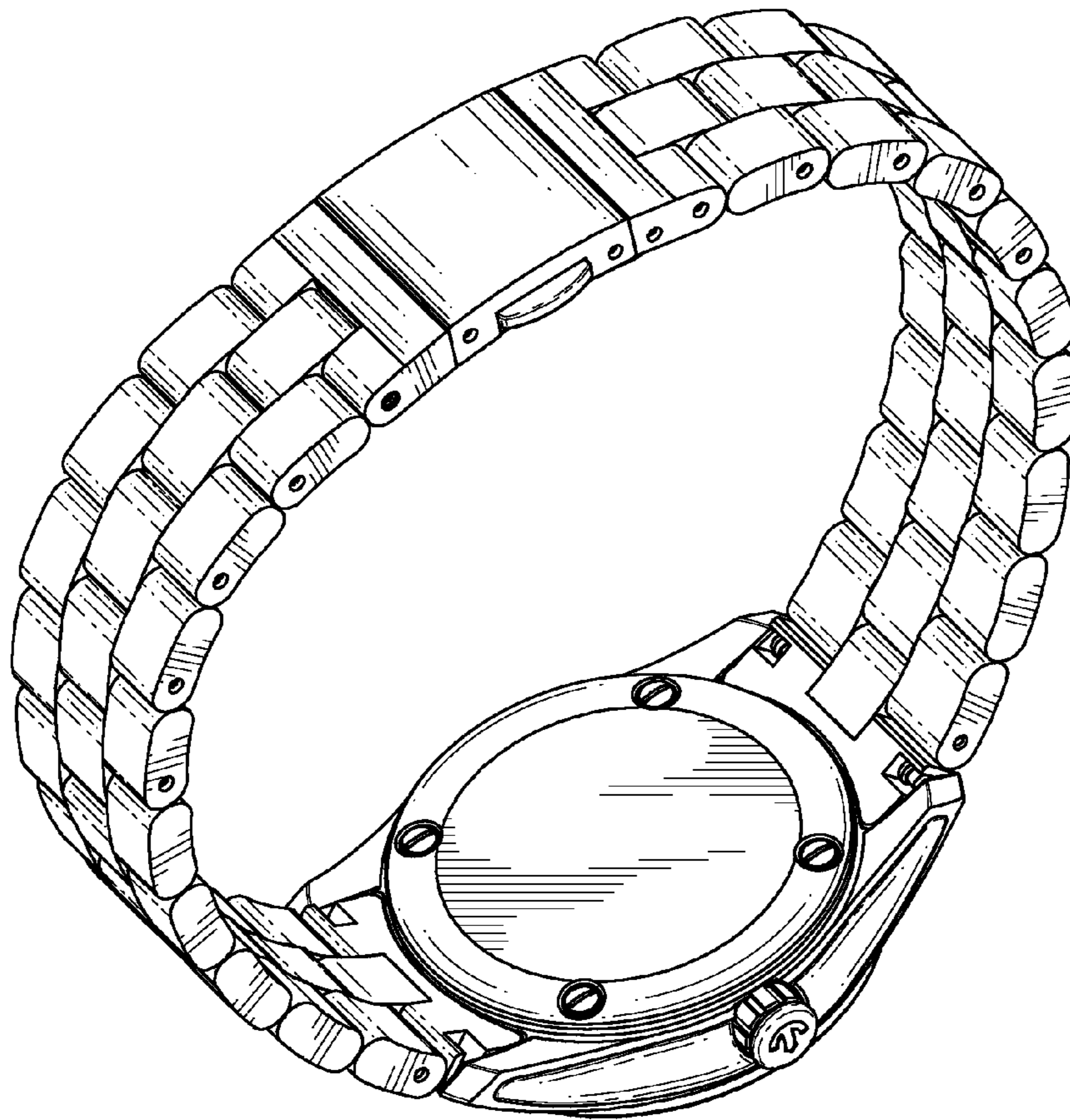

FIG. 2

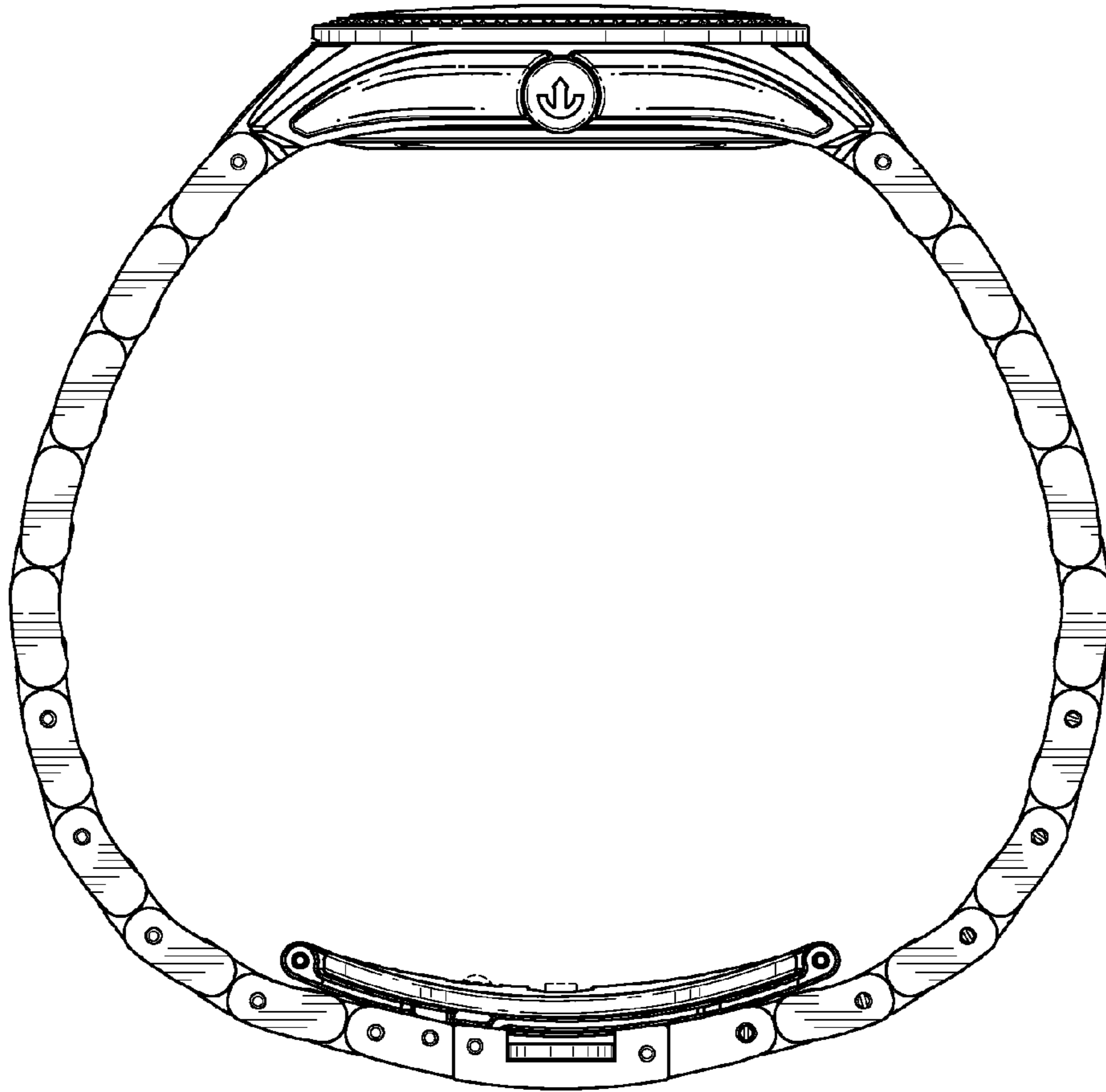

FIG. 3

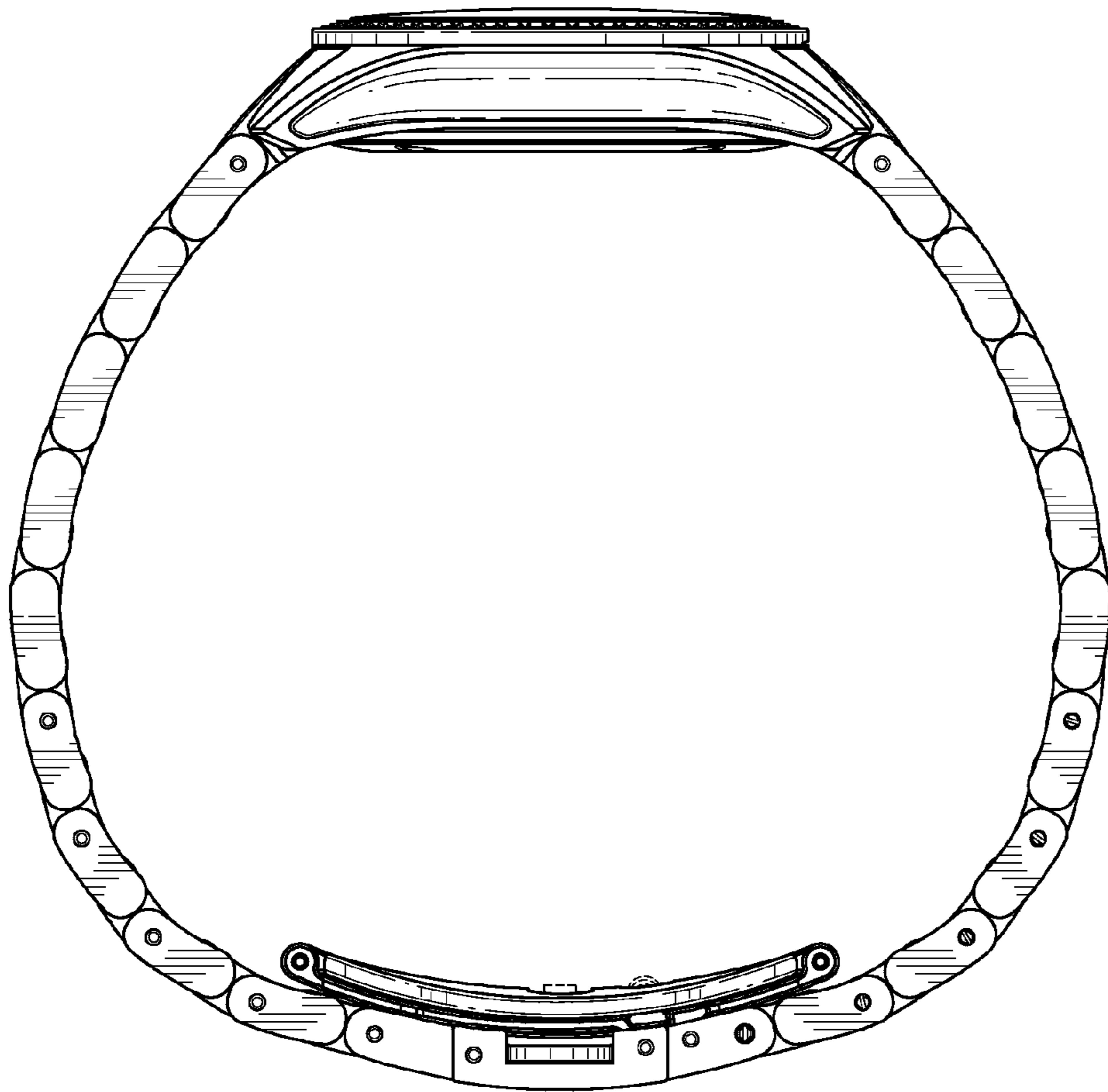

FIG.4

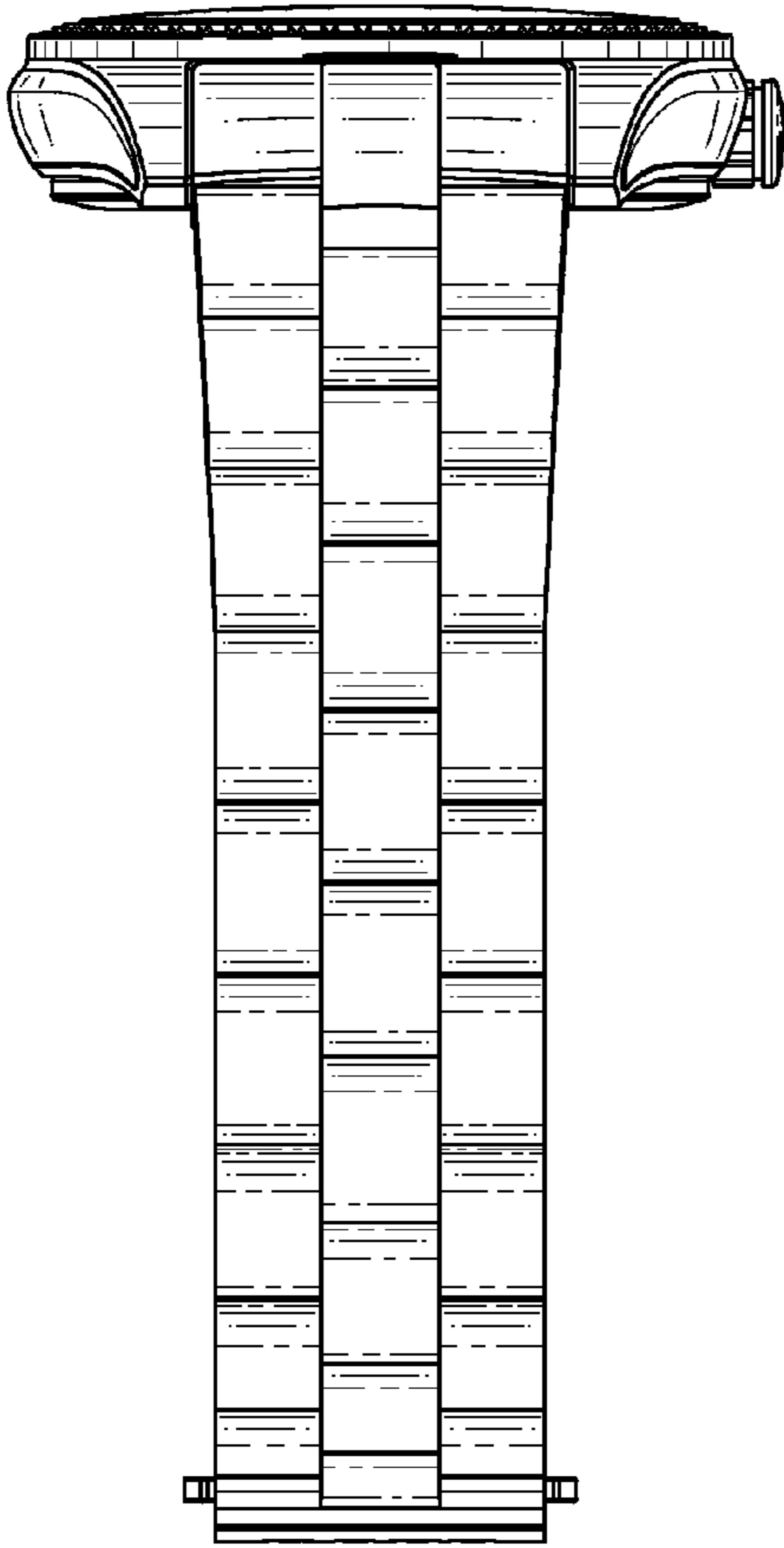

FIG. 5

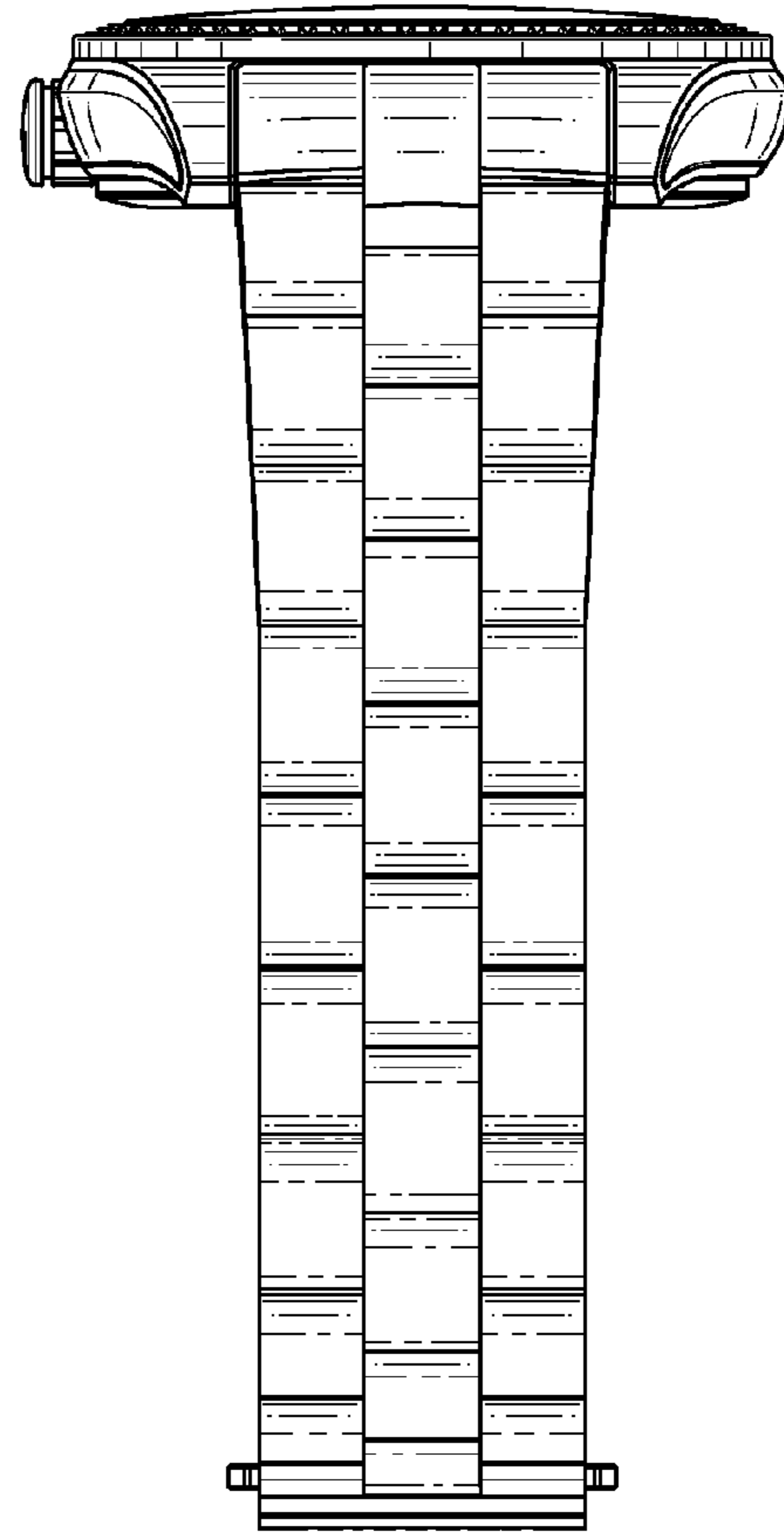

FIG. 6

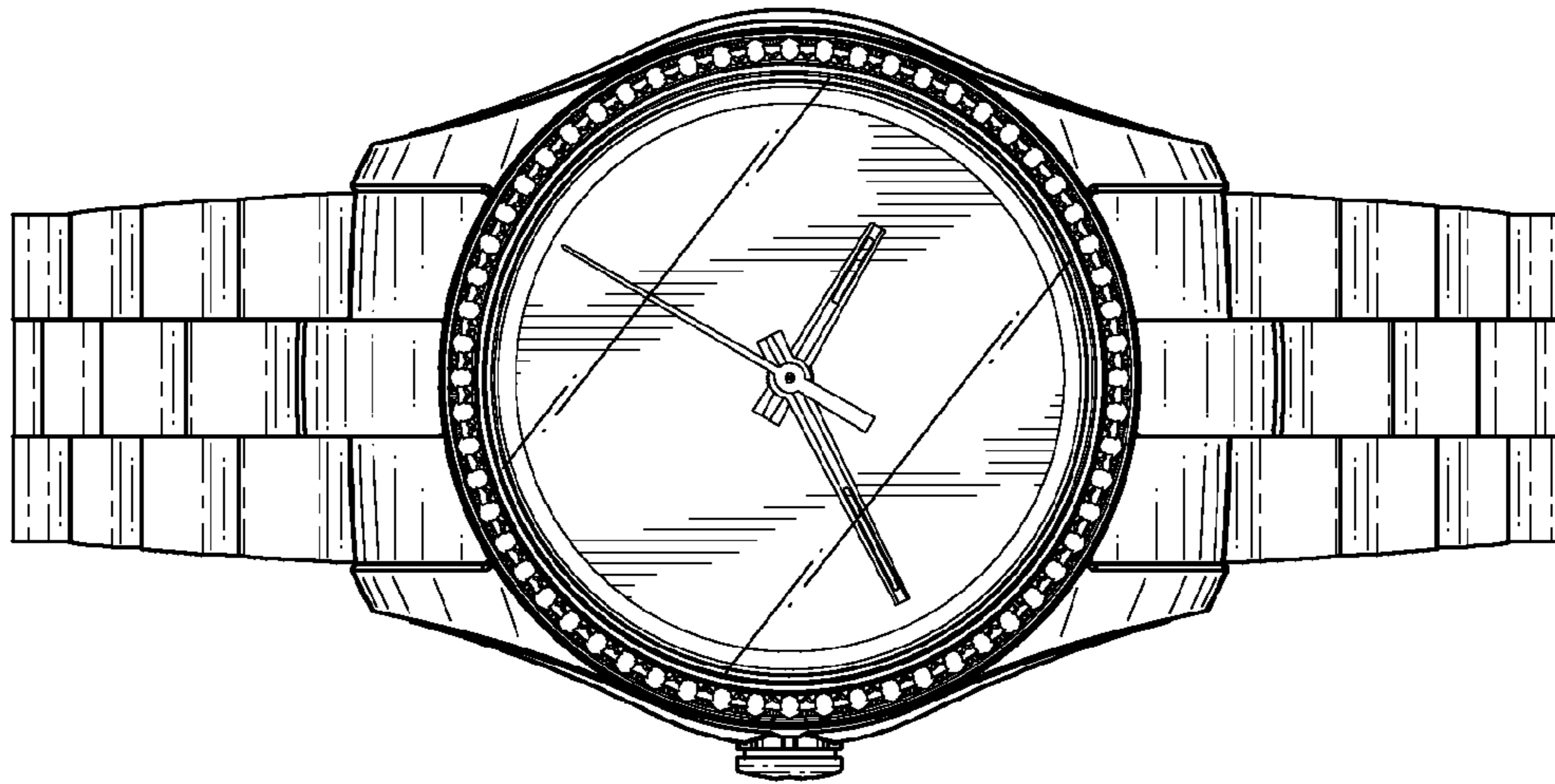

FIG. 7

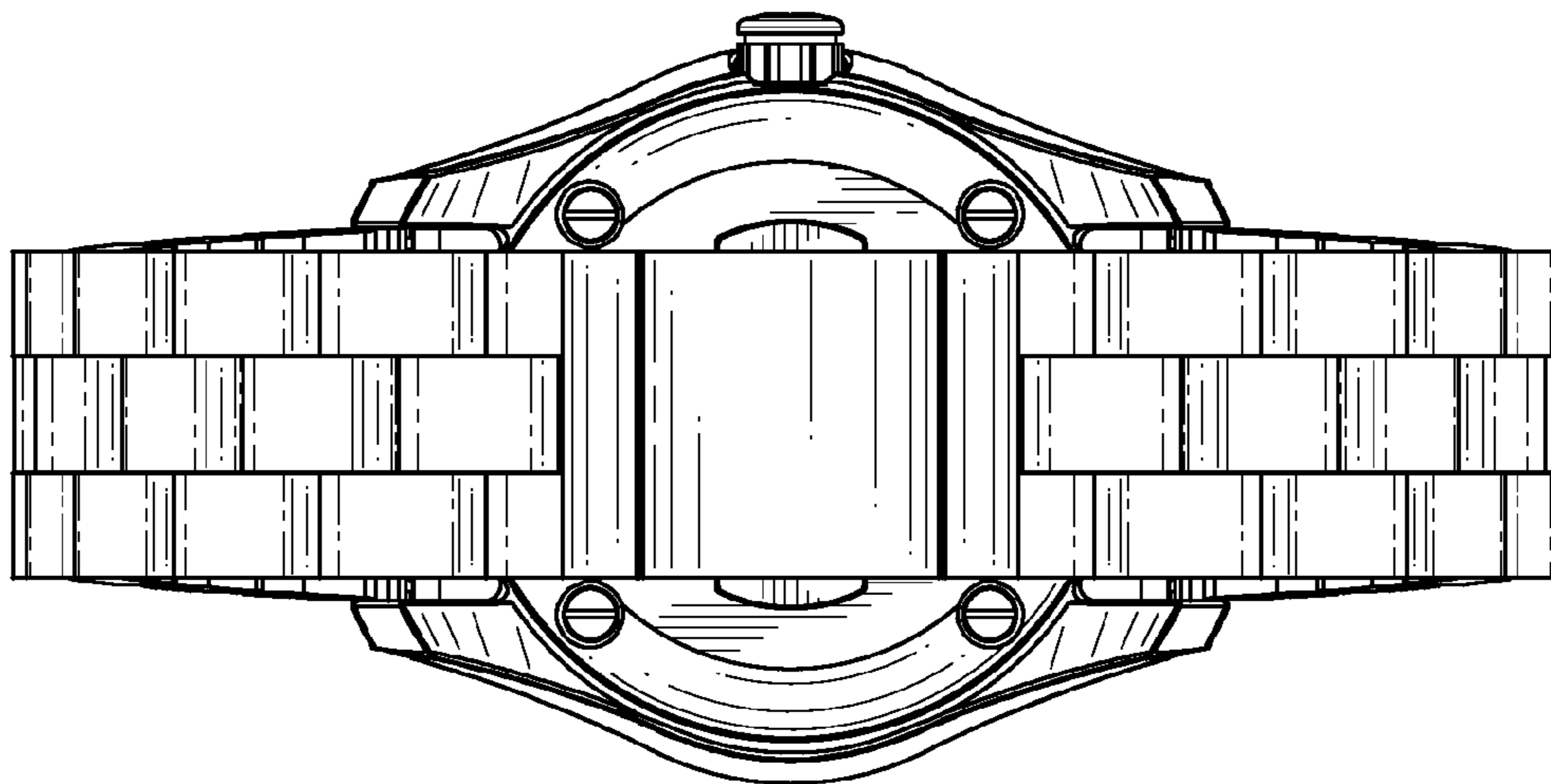

FIG. 8