



US00D691447S

(12) **United States Design Patent**
Weathersby et al.

(10) **Patent No.:** **US D691,447 S**
(45) **Date of Patent:** **** Oct. 15, 2013**

(54) **LOCKSET ASSEMBLY FOR A DOOR**

(71) Applicant: **Hampton Products International Corporation**, Foothill Ranch, CA (US)

(72) Inventors: **Steven T. Weathersby**, Lake Forest, CA (US); **John Kiechel**, Oakland, CA (US); **Sean Murphy**, San Francisco, CA (US); **Nasahn Adam Sheppard**, Mill Valley, CA (US); **James Sloss**, Cambridge, MA (US); **Andy Ward**, San Francisco, CA (US)

(73) Assignee: **Hampton Products International Corporation**, Foothill Ranch, CA (US)

(**) Term: **14 Years**

(21) Appl. No.: **29/434,325**

(22) Filed: **Oct. 11, 2012**

(51) **LOC (9) Cl.** **08-06**

(52) **U.S. Cl.**
USPC **D8/301; D8/310**

(58) **Field of Classification Search**
USPC D8/300, 301, 310, 343, 350, DIG. 2; 292/347, 337, 357; 16/110.1, 412, 414, 16/417, 430, 433, 441, 442, DIG. 30; 74/553; 70/224

See application file for complete search history.

(56) **References Cited**

U.S. PATENT DOCUMENTS

337,093	A *	3/1886	Thistle	292/347
794,779	A *	7/1905	Caley et al.	292/357
1,060,413	A *	4/1913	Augenbraun	70/107
1,186,233	A *	6/1916	Sanderson	292/347
1,653,513	A *	12/1927	Schlage	292/357
1,799,253	A *	4/1931	Rogers	292/350
1,996,357	A *	4/1935	Voight	292/347
2,023,941	A *	12/1935	Voight	70/224

2,082,351	A *	6/1937	Moore	70/224
2,094,982	A *	10/1937	Gerard	292/347
2,517,803	A *	8/1950	Seaholm	292/347
2,688,181	A *	9/1954	Livermont et al.	428/583
2,721,597	A *	10/1955	Pitrella	16/86 A
2,726,891	A *	12/1955	Gresham et al.	292/337
D176,713	S *	1/1956	Ellis	D8/310
D179,220	S *	11/1956	Russell	D8/310
D179,458	S *	12/1956	Ohno	D8/310
D179,679	S *	2/1957	Ellis	D8/310
2,797,950	A *	7/1957	Michael	292/347
D180,818	S *	8/1957	Clayton	D8/310
2,812,967	A *	11/1957	Falk	292/347
2,841,432	A *	7/1958	Ahlquist et al.	292/169.18
2,967,728	A *	1/1961	Falk	292/347

(Continued)

Primary Examiner — Paula Greene

(74) *Attorney, Agent, or Firm* — Klein, O'Neill & Singh, LLP

(57) **CLAIM**

The ornamental design for a lockset assembly for a door, as shown and described.

DESCRIPTION

FIG. 1 is a perspective view, taken from the front, top and right side, of a lockset assembly for a door, in accordance with my new design;

FIG. 2 is a front elevational view of the lockset assembly for a door shown in FIG. 1;

FIG. 3 is a top plan view of the lockset assembly for a door shown in FIG. 1, the bottom plan view being identical thereto;

FIG. 4 is a left side elevational view of the lockset assembly for a door shown in FIG. 1;

FIG. 5 is a right side elevational view of the lockset assembly for a door shown in FIG. 1; and,

FIG. 6 is a rear elevational view of the lockset assembly for a door shown in FIG. 1.

The broken lines illustrate environmental structure which forms no part of the claimed design.

1 Claim, 3 Drawing Sheets

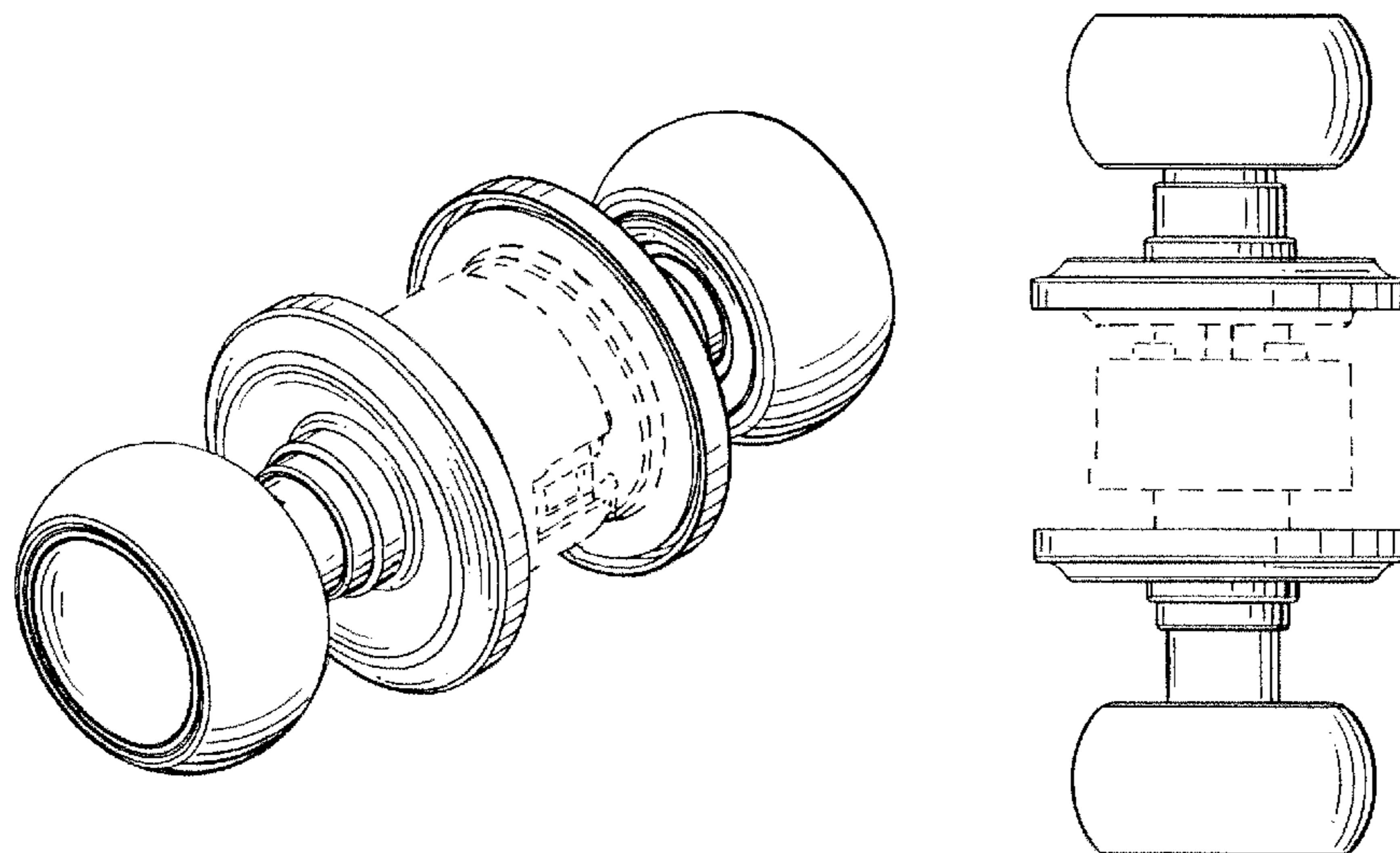

(56)

References Cited

U.S. PATENT DOCUMENTS

2,976,073	A *	3/1961	Russell et al.	292/352	3,149,871	A *	9/1964	Russell et al.	292/352
2,993,720	A *	7/1961	Russell	292/347	3,459,448	A *	8/1969	Armstrong et al.	292/336.5
2,998,274	A *	8/1961	Russell	292/169.17	D225,393	S *	12/1972	Giandonmencio	D8/310
3,012,808	A *	12/1961	Zion	292/347	D297,807	S *	9/1988	Fildan	D8/302
3,017,213	A *	1/1962	Kendrick	292/357	D427,291	S *	6/2000	Milrud et al.	D23/254
3,065,014	A *	11/1962	Russell	292/356	D454,049	S *	3/2002	LaPlume et al.	D8/301
3,075,796	A *	1/1963	Russell et al.	292/336.3	D493,686	S *	8/2004	Fields	D8/310
3,096,115	A *	7/1963	Patriquin et al.	292/347	6,874,341	B1 *	4/2005	Shen	70/224
3,111,021	A *	11/1963	Patriquin et al.	70/476	7,100,407	B2 *	9/2006	Chen	70/224
3,125,877	A *	3/1964	Fryer	70/224	D542,115	S *	5/2007	Hanna et al.	D8/310
					D565,385	S *	4/2008	Jou	D8/307
					D592,484	S *	5/2009	Ricereto	D8/310

* cited by examiner

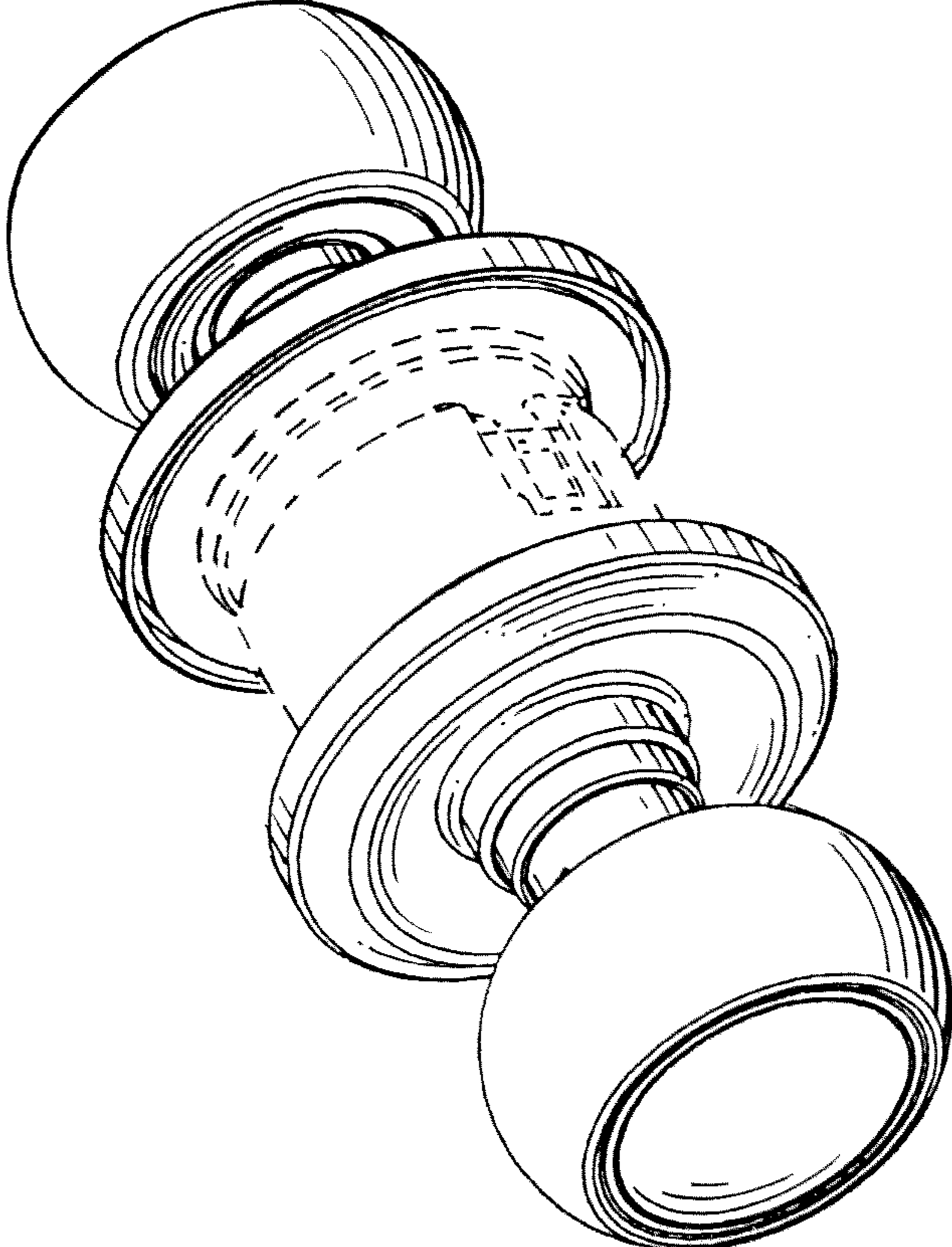

FIG. 1

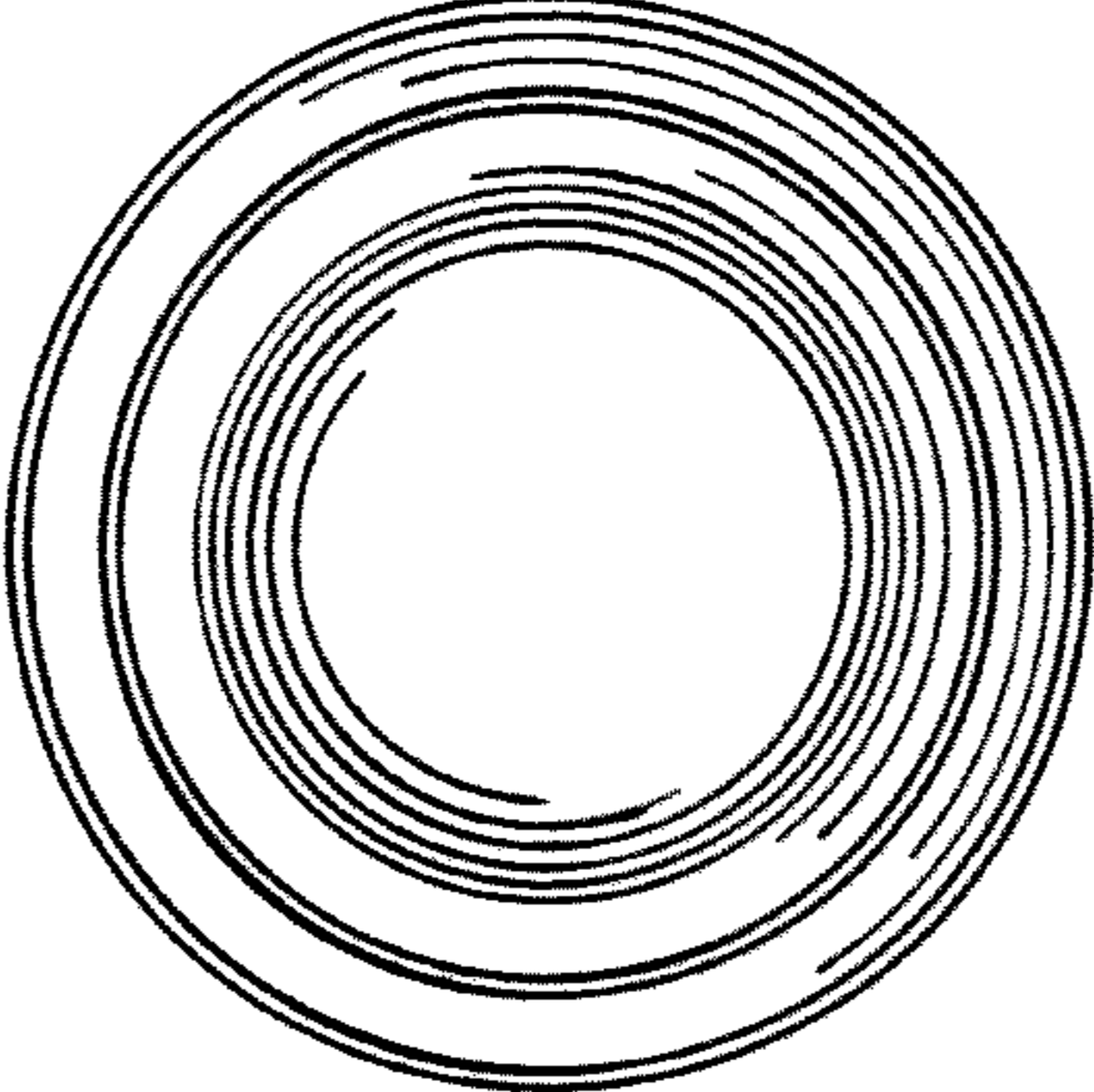

FIG. 6

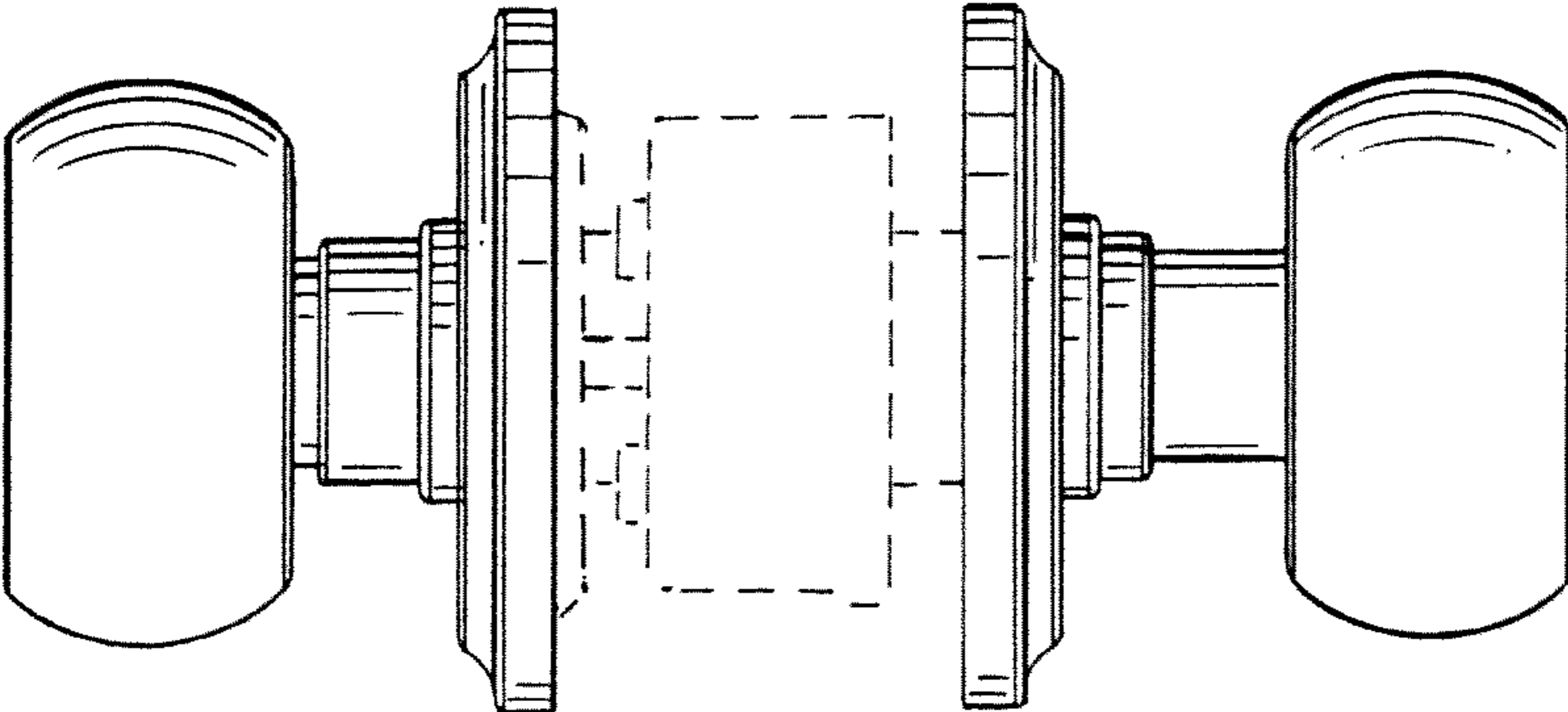

FIG. 3

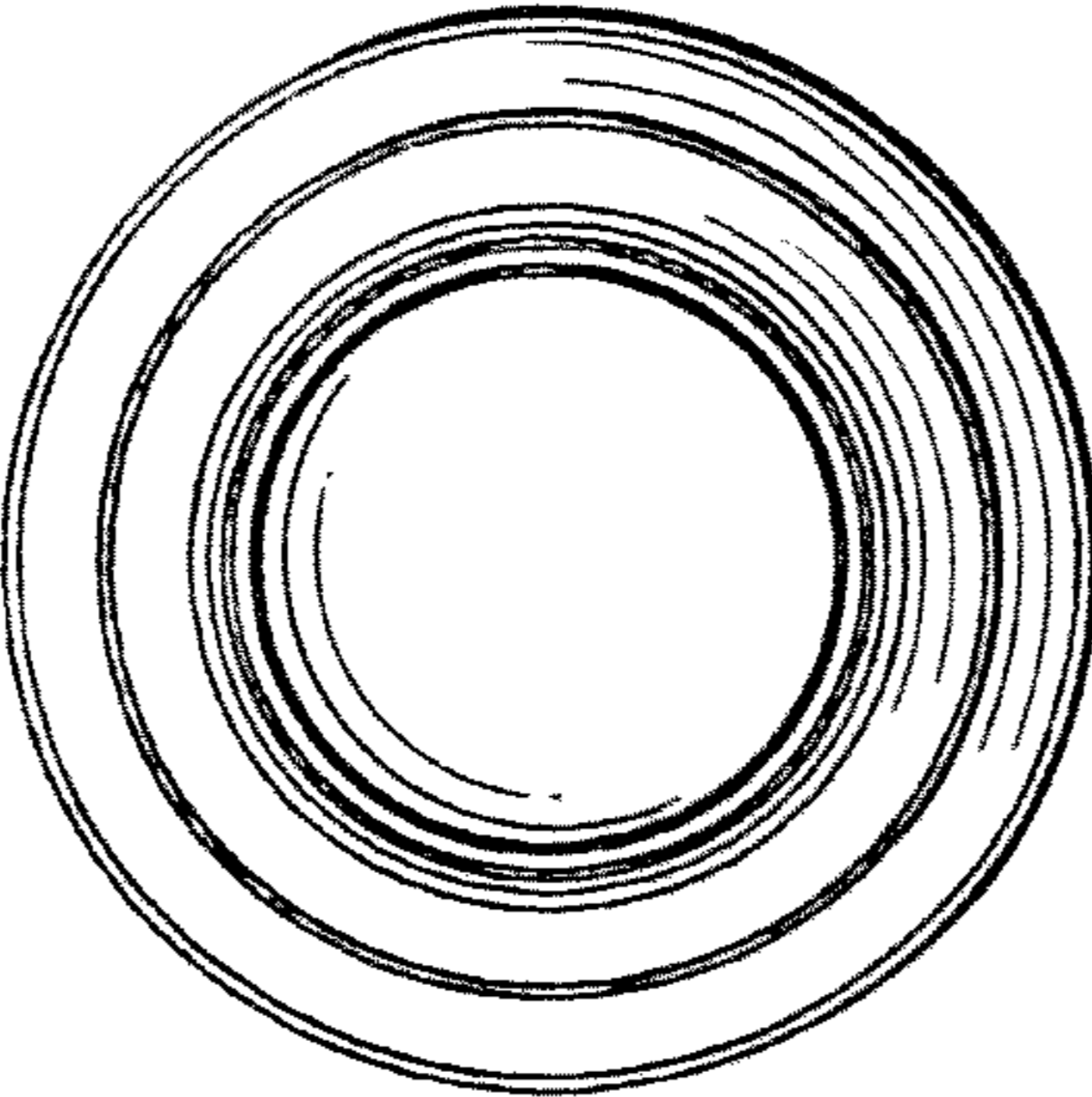

FIG. 2

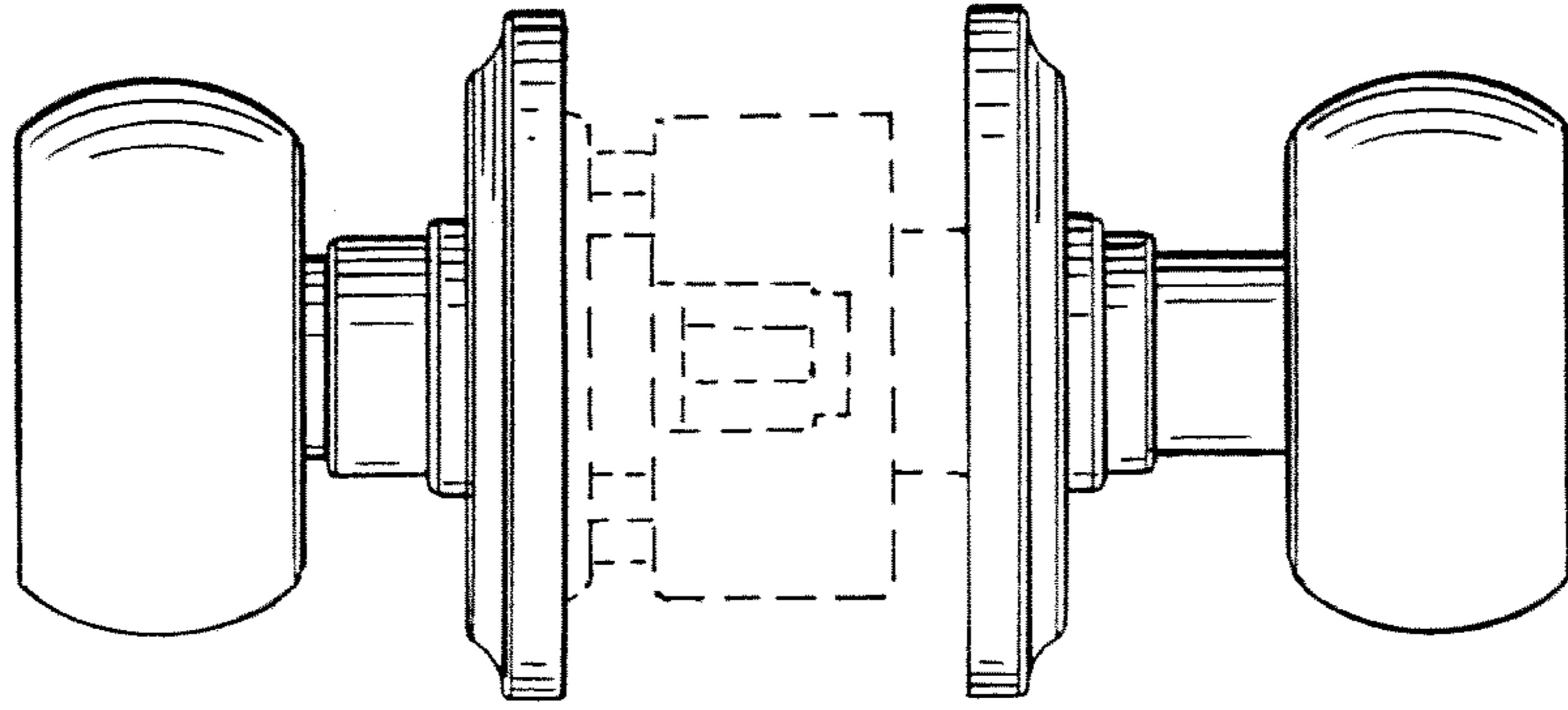

FIG. 5

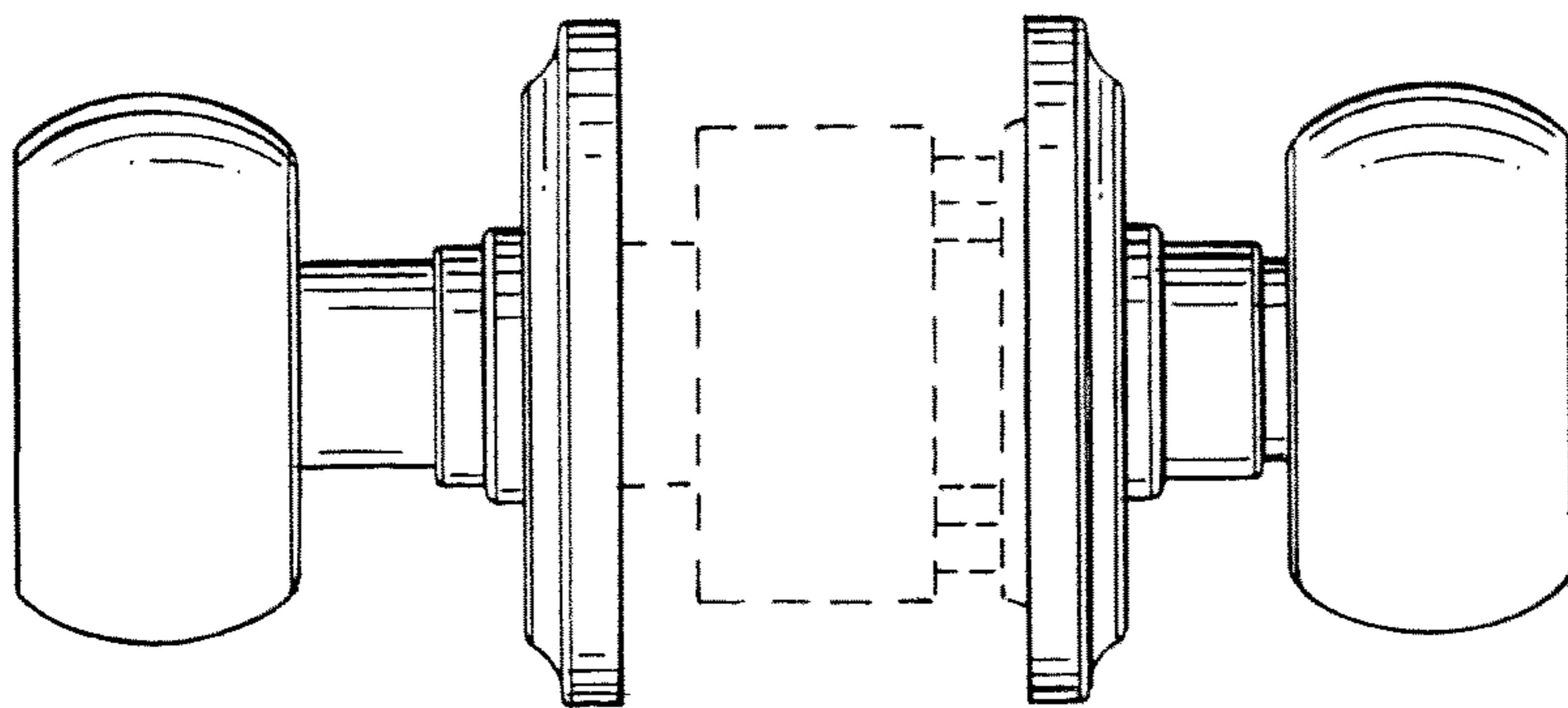

FIG. 4