



US00D691351S

(12) **United States Design Patent**
Pugazhenthhi

(10) **Patent No.:** **US D691,351 S**

(45) **Date of Patent:** **** Oct. 15, 2013**

(54) **FOOTWEAR**

(75) Inventor: **Arthi Pugazhenthhi**, Boulder, CO (US)

(73) Assignee: **Crocs, Inc.**, Niwot, CO (US)

(**) Term: **14 Years**

(21) Appl. No.: **29/415,436**

(22) Filed: **Mar. 9, 2012**

(51) **LOC (9) Cl.** **02-04**

(52) **U.S. Cl.**
USPC **D2/896; D2/926**

(58) **Field of Classification Search**
USPC D2/896, 900, 916, 917, 923, 943,
D2/946-96, 969, 972; 36/45, 8, 100, 88,
36/102, 112, 113, 3 A, 3 R, 7.4, 11.5, 4, 87,
36/7.5, 25 R

See application file for complete search history.

(56) **References Cited**

U.S. PATENT DOCUMENTS

D153,728 S	5/1949	Reinhart et al.	
4,408,401 A	10/1983	Seidel et al.	
D280,461 S	9/1985	Horn	
D310,289 S	9/1990	Farina	
5,369,895 A	12/1994	Hammerschmidt	
D381,794 S	8/1997	Gelli	
D416,667 S	11/1999	Lamstein	
D473,040 S	4/2003	Hawker et al.	
D479,034 S	9/2003	Tzenos	
D479,906 S	9/2003	Hawker et al.	
D498,901 S	11/2004	Hawker et al.	
6,993,858 B2	2/2006	Seamans	
D517,788 S	3/2006	Seamans	
D517,789 S	3/2006	Seamans	
D517,790 S	3/2006	Seamans	
D525,419 S	7/2006	Seamans	
D528,271 S	9/2006	Issler	
D529,263 S *	10/2006	Wolf	D2/923

7,146,751 B2	12/2006	Seamans	
D535,088 S	1/2007	Seamans	
D543,341 S	5/2007	Seamans	
D543,681 S	6/2007	McCarthy	
D545,032 S *	6/2007	Wolf	D2/923

(Continued)

FOREIGN PATENT DOCUMENTS

EM	0000611220001 A	8/2003
GB	2322286 A	8/1998
WO	WO2004105531 A1	12/2004
WO	WO2004105534 A2	12/2004

OTHER PUBLICATIONS

Buddy by Calzuro: A New Born in the Calzuro's Family, <http://www.calzuro.it/news.php?lang=en&id=20> (May 13, 2009) (6 pages).

(Continued)

Primary Examiner — Robert M Spear

Assistant Examiner — Rashida C McCoy

(74) *Attorney, Agent, or Firm* — Faegre Baker Daniels LLP

(57) **CLAIM**

The ornamental design for footwear, as shown and described.

DESCRIPTION

FIG. 1 is a front perspective view.

FIG. 2 is an outer side view.

FIG. 3 is an inner side view.

FIG. 4 is a front view.

FIG. 5 is a back view.

FIG. 6 is a top view; and,

FIG. 7 is a bottom view.

The broken lines in the drawings represent unclaimed environmental subject matter and form no part of the claim.

The CROCS word mark and logo forming part of the disclosure is a registered trademark of Crocs, Inc.

1 Claim, 7 Drawing Sheets

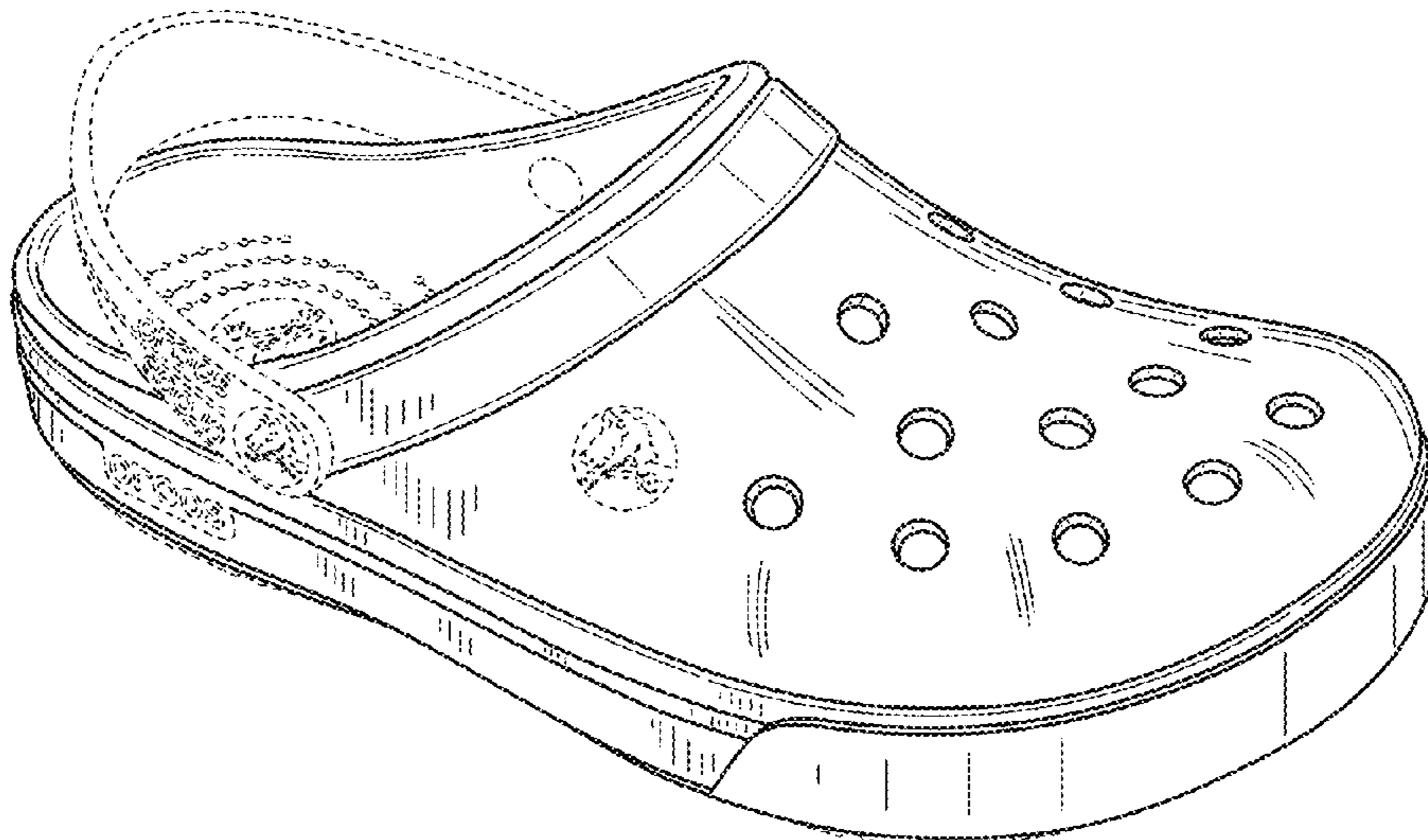

(56)

References Cited

U.S. PATENT DOCUMENTS

D545,033 S 6/2007 Wolf
 D561,982 S 2/2008 Hoyt
 D563,082 S 3/2008 Seamans
 D564,184 S 3/2008 Issler
 D564,204 S 3/2008 Seamans
 D564,205 S 3/2008 Seamans
 D564,207 S 3/2008 Seamans
 D564,208 S 3/2008 Seamans
 D564,749 S 3/2008 Seamans
 D567,482 S 4/2008 Hoyt
 D567,483 S * 4/2008 Liow D2/896
 D571,547 S 6/2008 Yang
 D573,778 S 7/2008 Hawker
 D575,937 S 9/2008 Klavano
 D578,743 S * 10/2008 Liow D2/896
 D579,182 S 10/2008 Klavano
 D579,651 S 11/2008 Hearn
 D584,032 S 1/2009 Jarosik
 D584,037 S 1/2009 Del Biondi et al.
 D590,588 S * 4/2009 del Biondi et al. D2/969
 D593,287 S 6/2009 Del Biondi et al.
 D599,538 S 9/2009 Del Biondi et al.
 D600,907 S 9/2009 Boyd et al.
 D610,784 S 3/2010 Del Biondi

D613,485 S 4/2010 Meador
 D624,733 S * 10/2010 O'Boyle et al. D2/923
 D630,007 S * 1/2011 Satz D2/923
 D632,465 S 2/2011 Del Biondi et al.
 D642,773 S * 8/2011 Liow D2/923
 D645,235 S 9/2011 Carroll et al.
 D650,157 S * 12/2011 Liow D2/923
 D667,612 S * 9/2012 Del Biondi et al. D2/896
 2004/0231189 A1 11/2004 Seamans
 2004/0231190 A1 11/2004 Seamans
 2004/0231191 A1 11/2004 Seamans
 2006/0048407 A1 3/2006 Seamans
 2007/0130797 A1 6/2007 Seamans

OTHER PUBLICATIONS

Converse Flame Clog, <http://bagginsshoes.com/pic-pages/s5.html> (2 pages) (Nov. 6, 2009) (apparently archived on Jun. 5, 2008 based on <http://web.archive.org/web/20080605042453/http://bagginsshoes.com/pic-pages/s5.html>).
 Converse, Buy—Classic Chuck's Collection, <http://www.converse.com/#/products/collections/specialcollection7> (Oct. 20, 2009) (9 pages).
 Crocs: Cayman, <http://www.crocs.com/crocs-cayman/10001.default.pd.html?q=cayman> (Nov. 3, 2009) (6 pages).

* cited by examiner

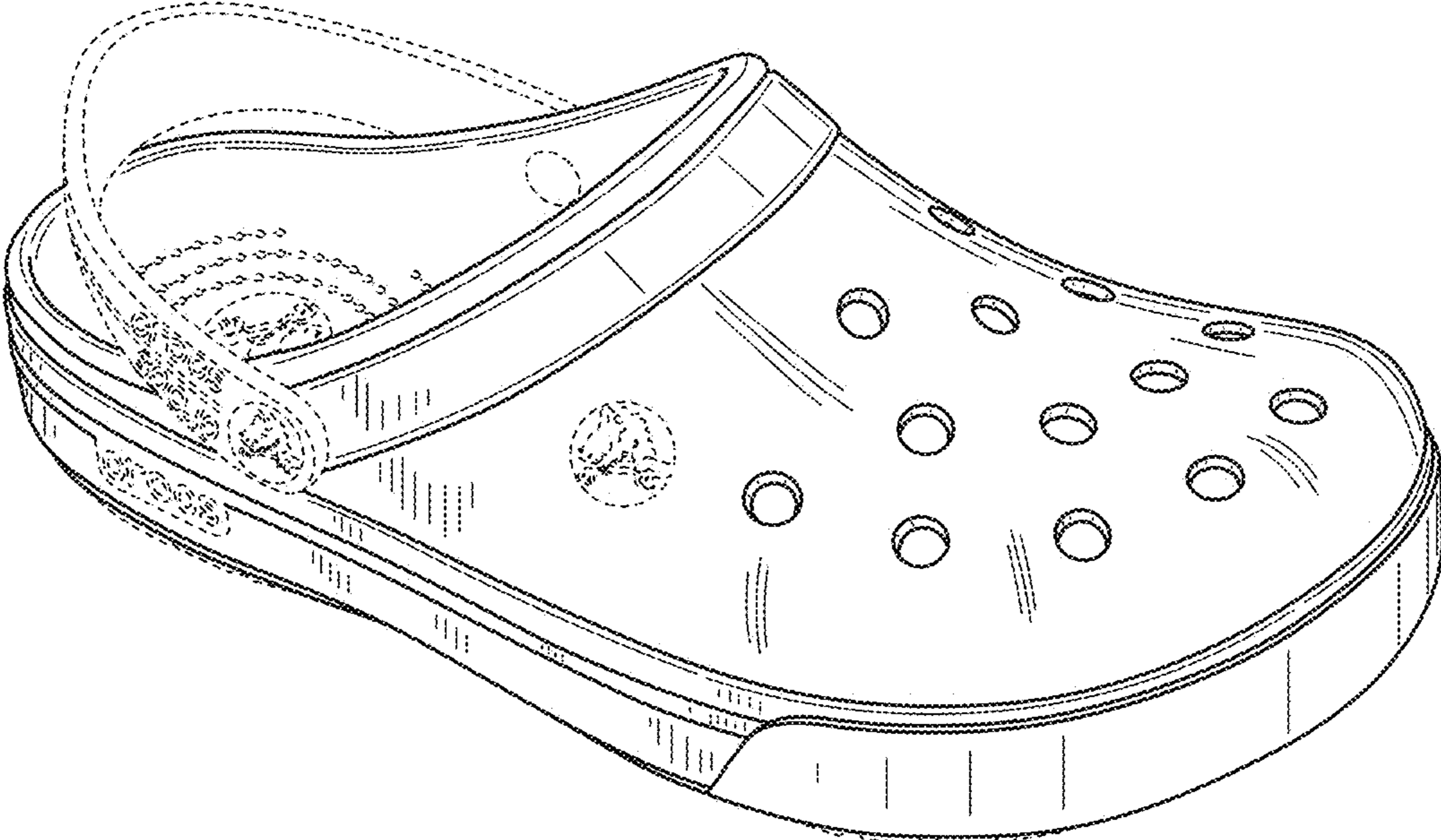

FIG.1

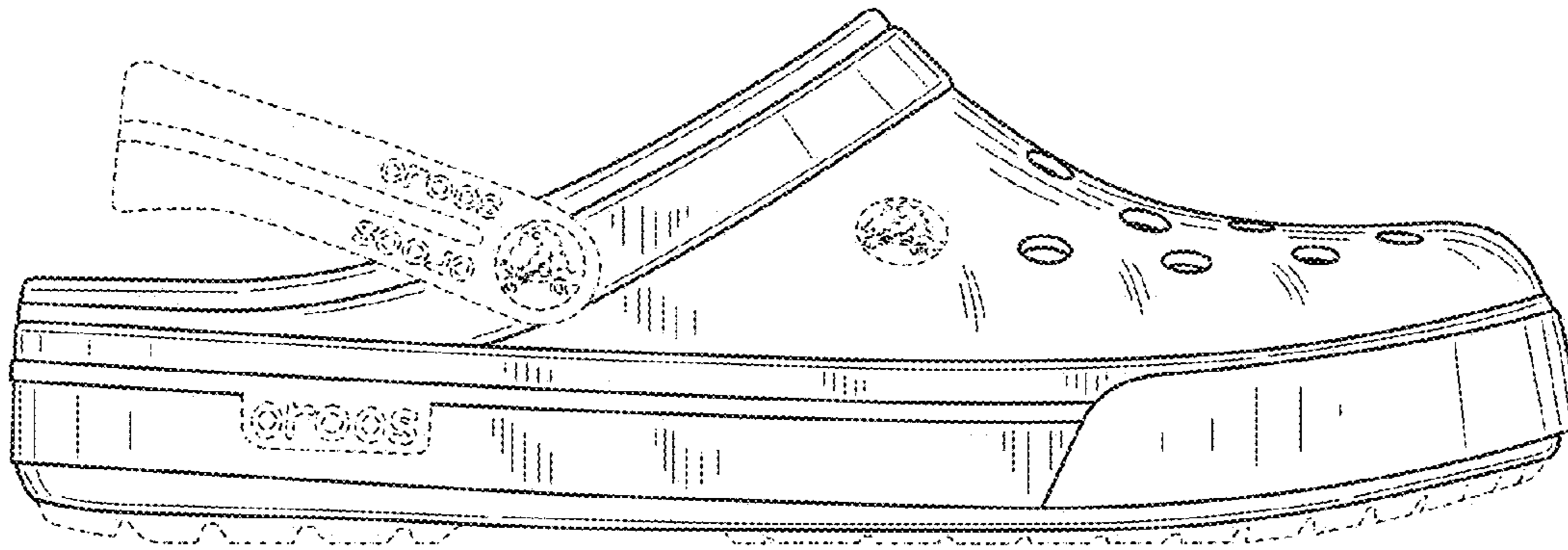

FIG. 2

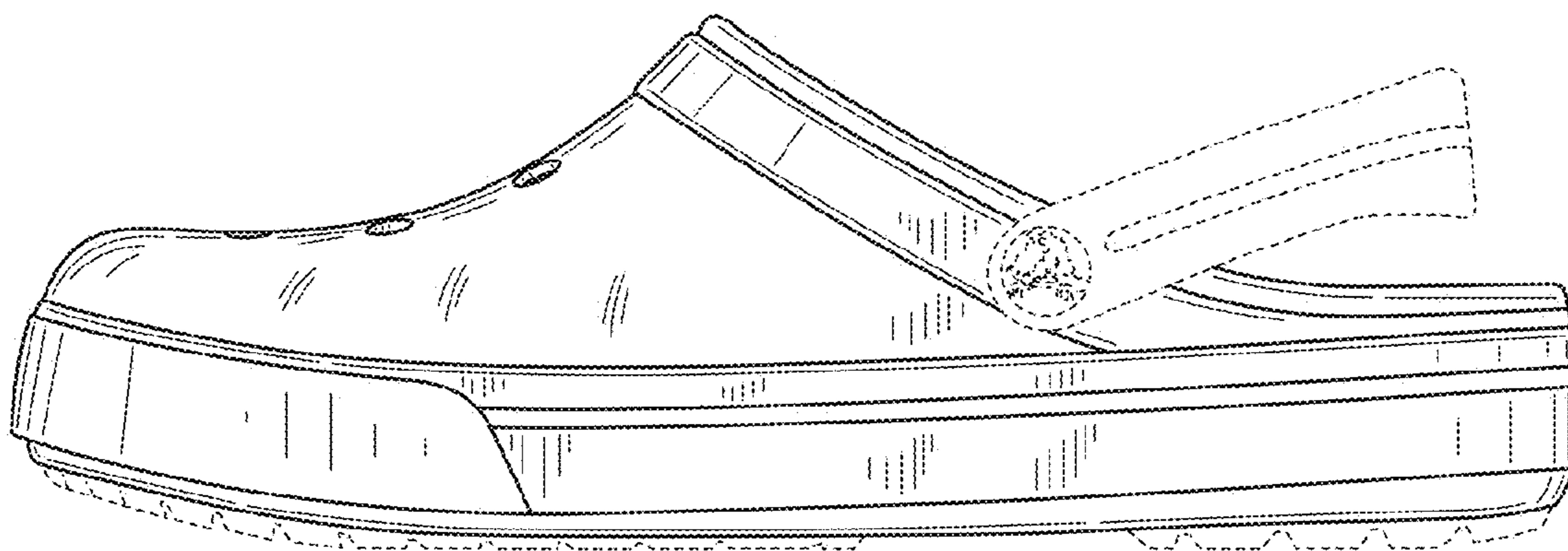

FIG.3

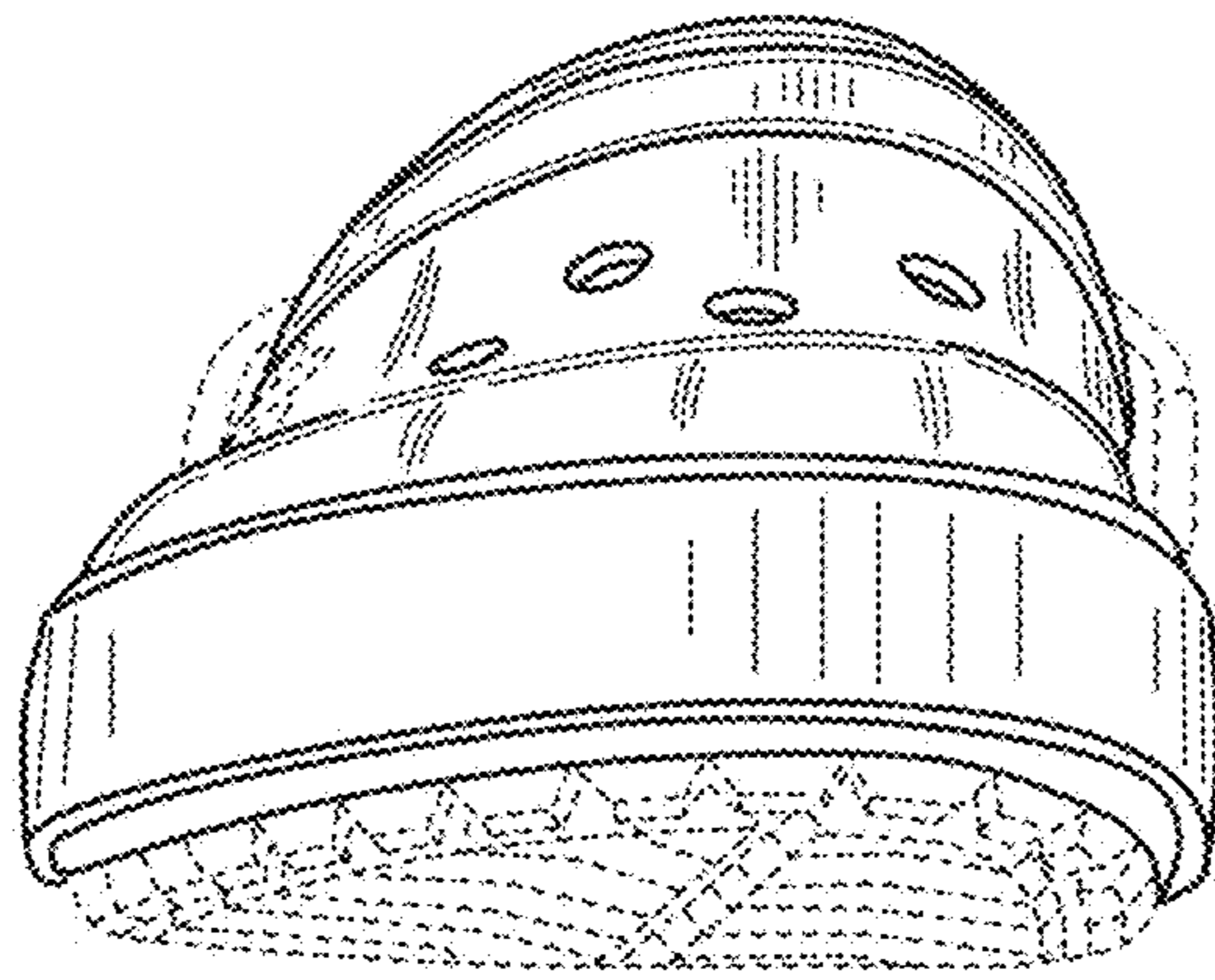

FIG.4

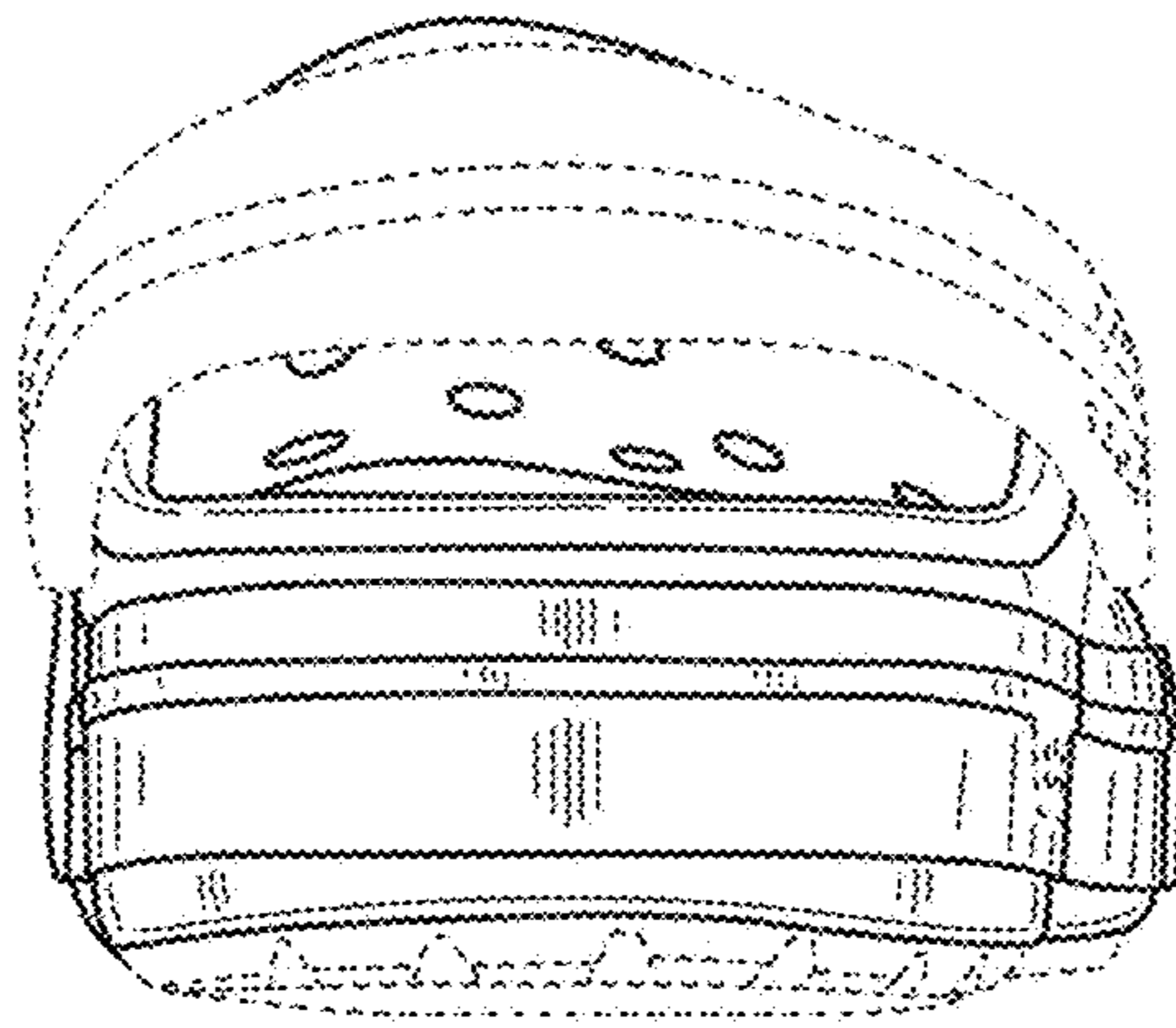

FIG.5

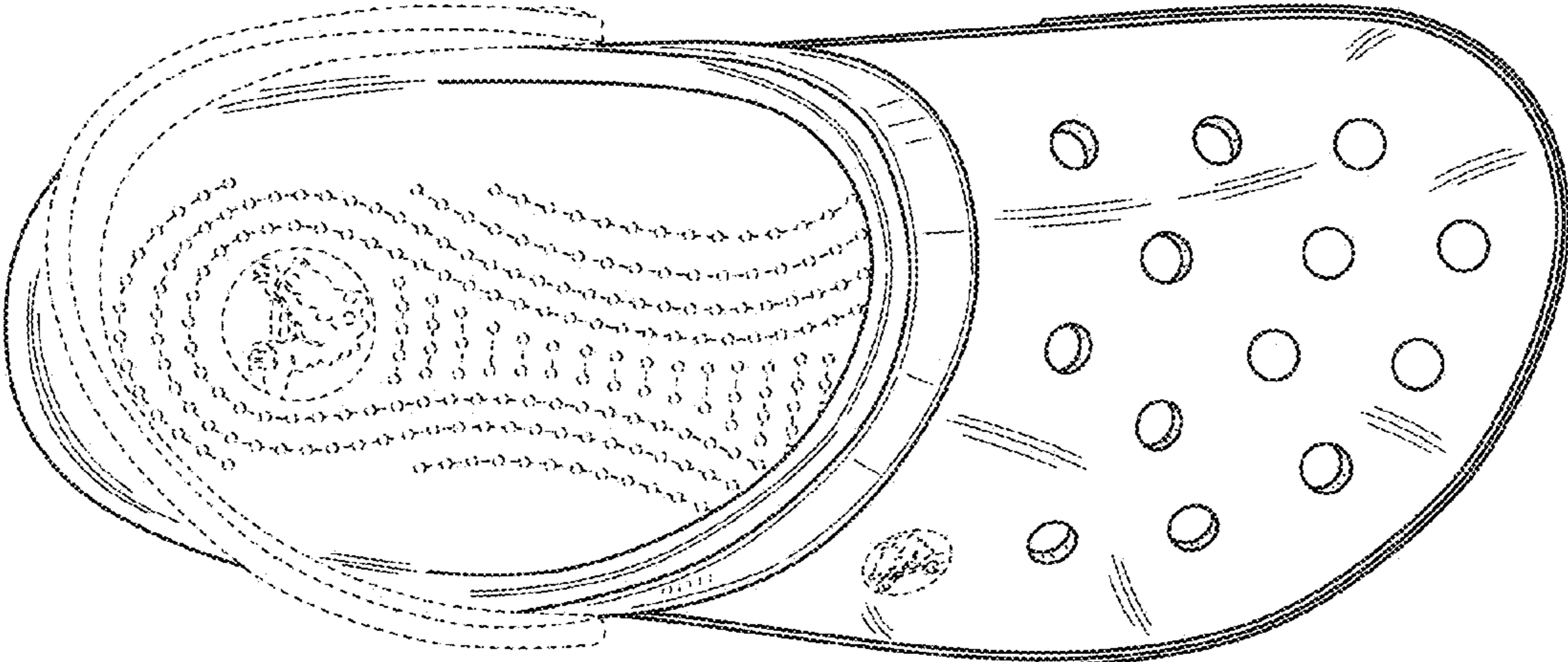

FIG.6

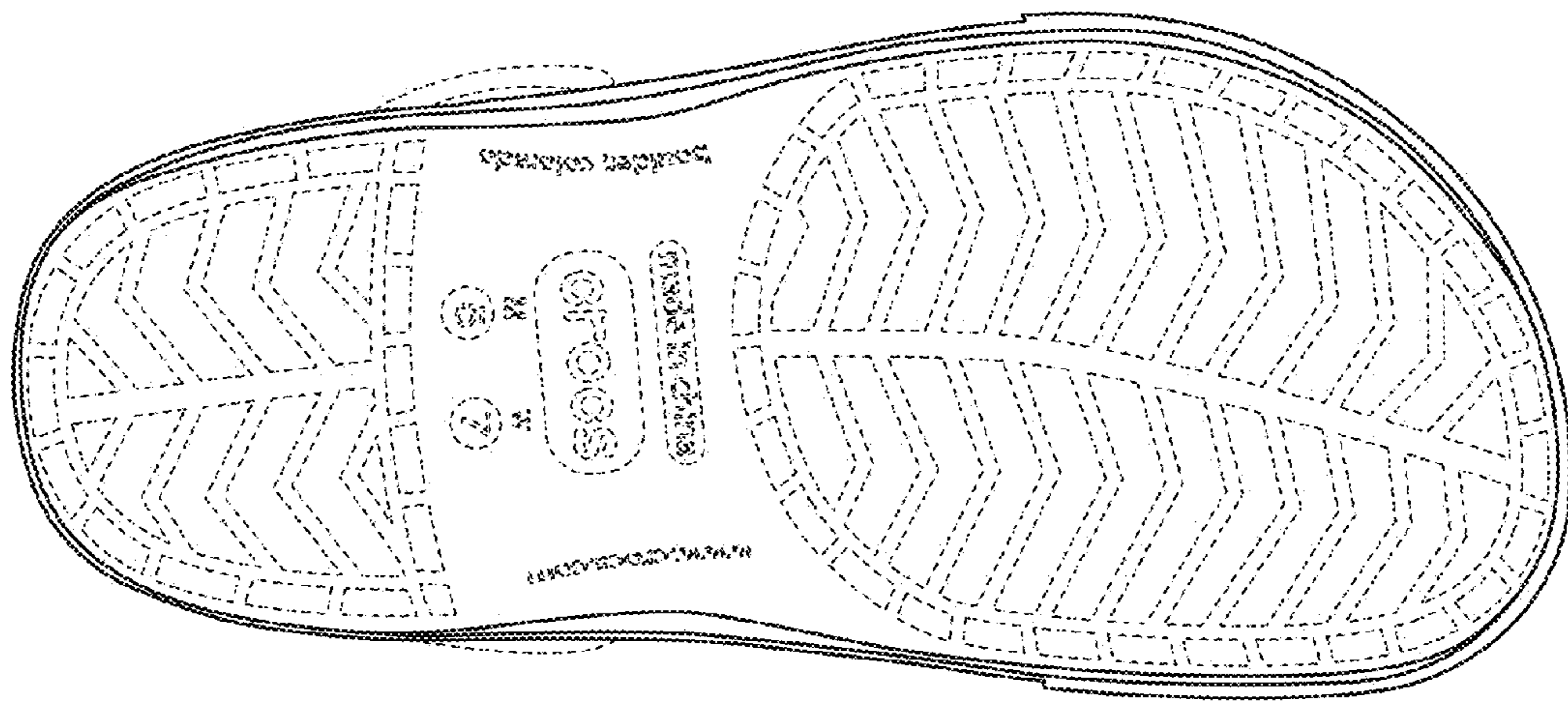

FIG. 7