

US00D691298S

(12) **United States Design Patent**
Binder et al.

(10) **Patent No.:** **US D691,298 S**

(45) **Date of Patent:** **** Oct. 8, 2013**

(54) **HEADLIGHT FOR A VEHICLE**

(71) Applicant: **Daimler AG**, Stuttgart (DE)

(72) Inventors: **Thomas Binder**, Stuttgart (DE);
Hans-Dieter Futschik, Gechingen (DE);
Stefan Handt, Stuttgart (DE); **Frank Pfisterer**, Weil der Stadt (DE); **Gorden Wagener**, Gaeufelden (DE)

(73) Assignee: **Daimler AG**, Stuttgart (DE)

(**) Term: **14 Years**

(21) Appl. No.: **29/444,250**

(22) Filed: **Jan. 29, 2013**

(30) **Foreign Application Priority Data**

Jul. 30, 2012 (WO) DM/078 807

(51) **LOC (9) Cl.** **26-06**

(52) **U.S. Cl.**
USPC **D26/28**

(58) **Field of Classification Search**
USPC D26/28-36; 362/459-468, 475-478,
362/485-487

See application file for complete search history.

(56) **References Cited**

U.S. PATENT DOCUMENTS

D538,956 S * 3/2007 Ishii D26/28
D544,614 S * 6/2007 Markefka D26/28

D561,358 S * 2/2008 Tachibana D26/28
D570,007 S * 5/2008 Hsu D26/28
D582,587 S * 12/2008 Yang D26/28
D593,232 S * 5/2009 Koman et al. D26/28
D596,078 S 7/2009 Pfeiffer et al.
D635,694 S * 4/2011 Yang et al. D26/28

* cited by examiner

Primary Examiner — Marcus Jackson
(74) *Attorney, Agent, or Firm* — Crowell & Moring LLP

(57) **CLAIM**
The ornamental design for a headlight for a vehicle, as shown and described.

DESCRIPTION

This application contains subject matter related to the following co-pending U.S. design patent application: Application Ser. No. 29/444,248, filed herewith and entitled "Headlight for a Vehicle".

FIG. 1 is a right perspective view of a first embodiment of a headlight for a vehicle according to the design;

FIG. 2 is a front view thereof;

FIG. 3 is a right side view thereof; and

FIG. 4 is a top view thereof.

FIG. 5 is a left perspective view of a second embodiment of a headlight for a vehicle showing our new design, with the headlight for a vehicle for the opposite side of the vehicle being depicted in the first embodiment;

FIG. 6 is a front view thereof;

FIG. 7 is a left side view thereof; and,

FIG. 8 is a top view thereof.

The broken lines are for illustrative purposes only and form no part of the claimed design.

1 Claim, 4 Drawing Sheets

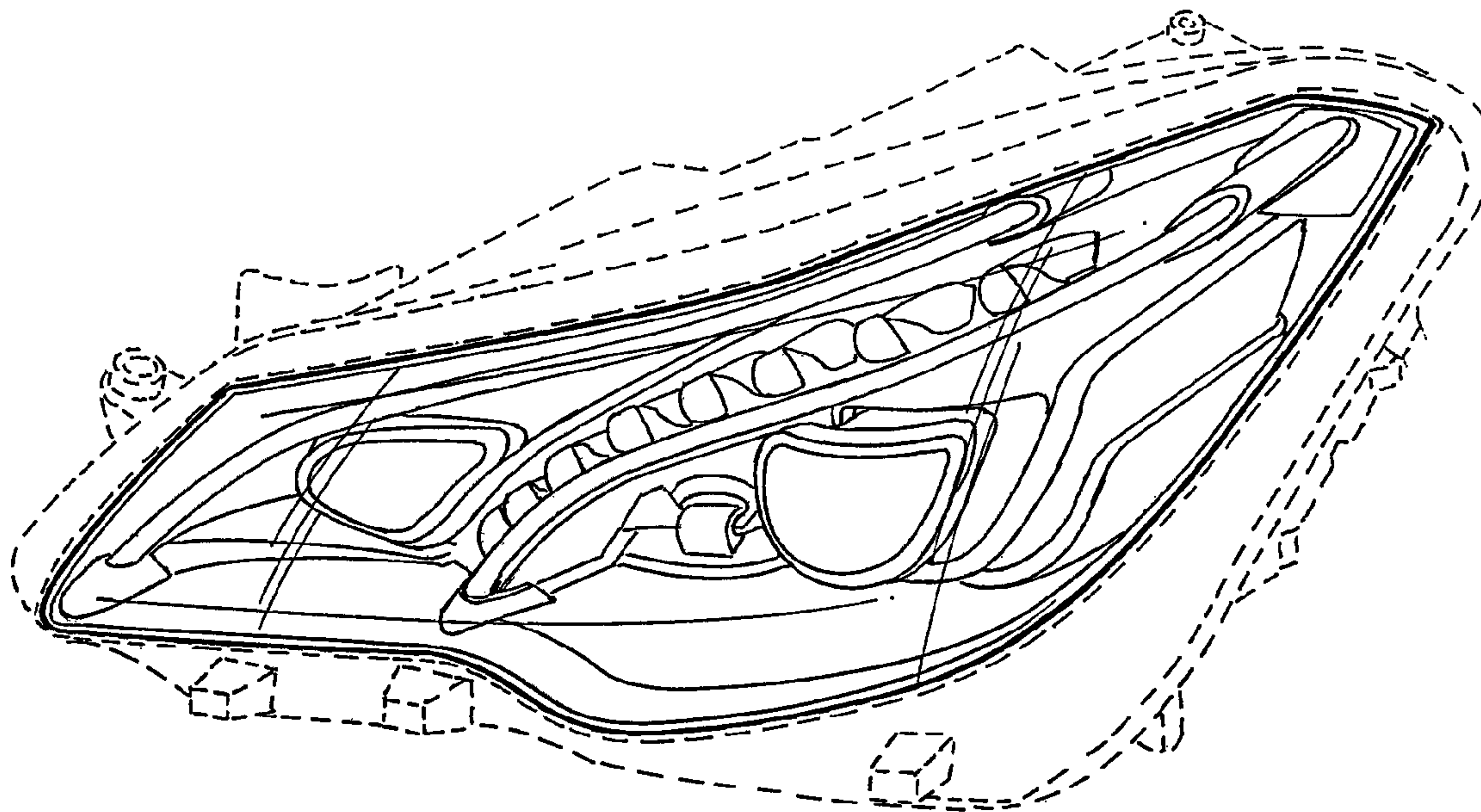

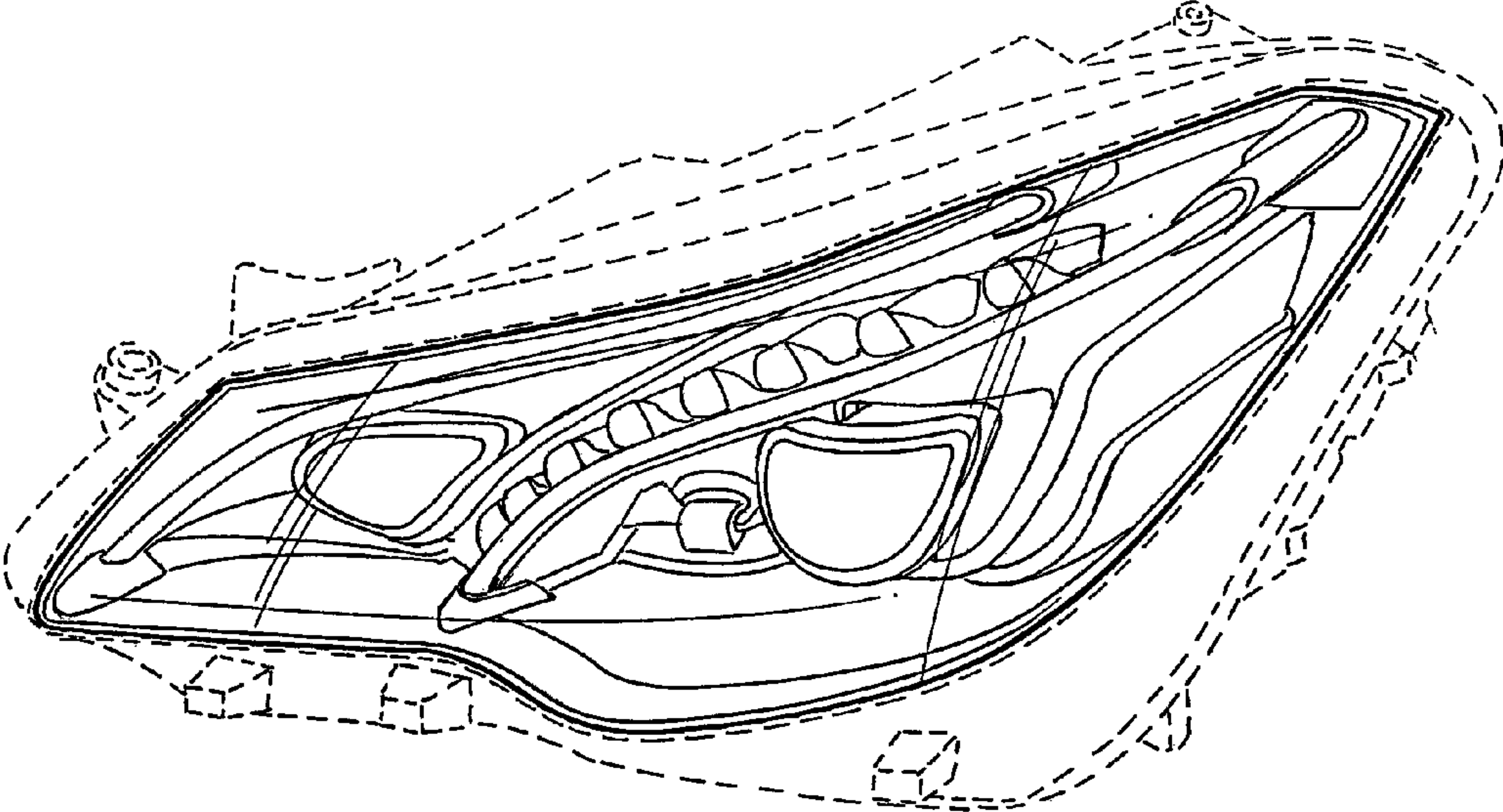

FIG. 1

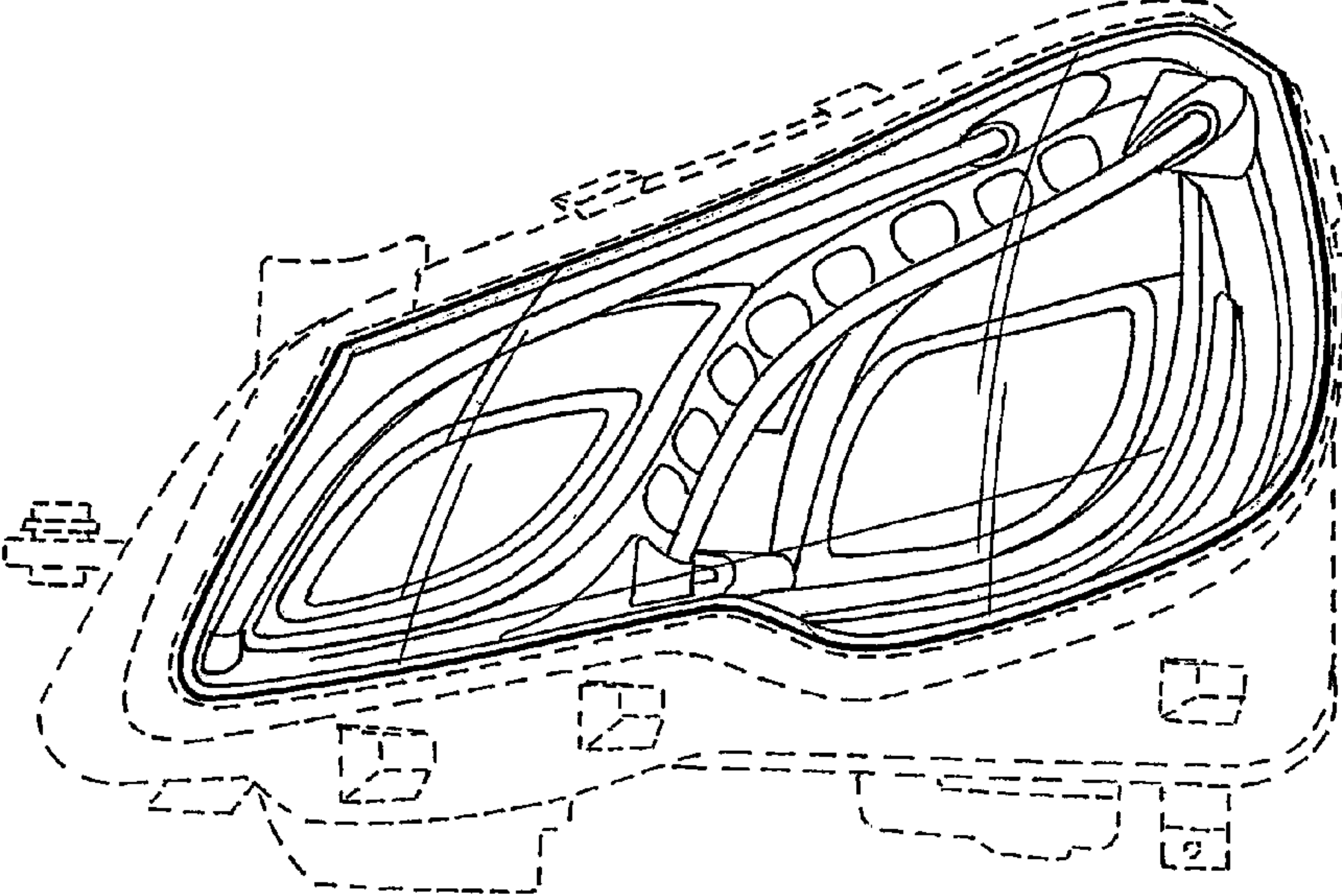

FIG. 2

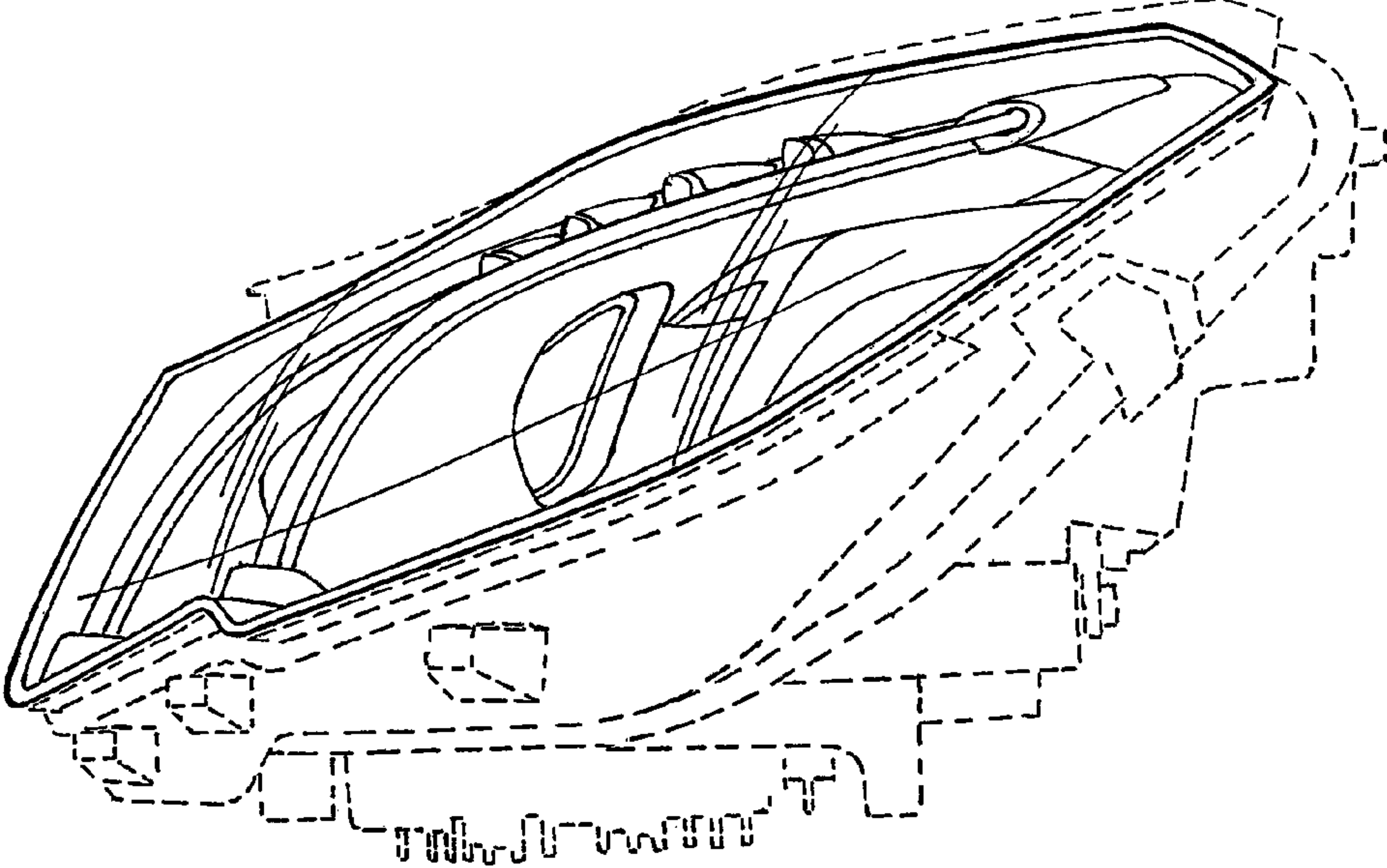

FIG. 3

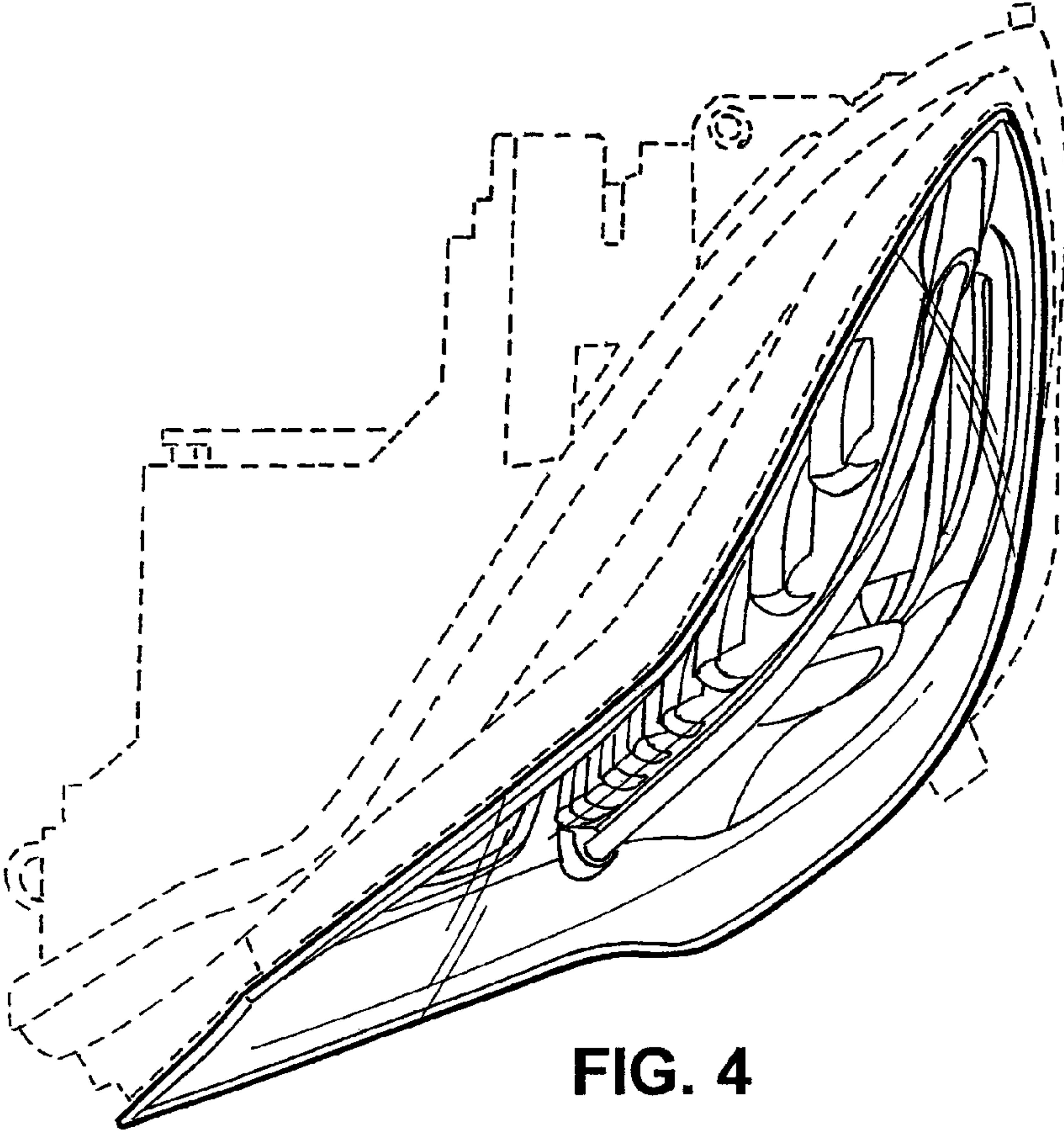

FIG. 4

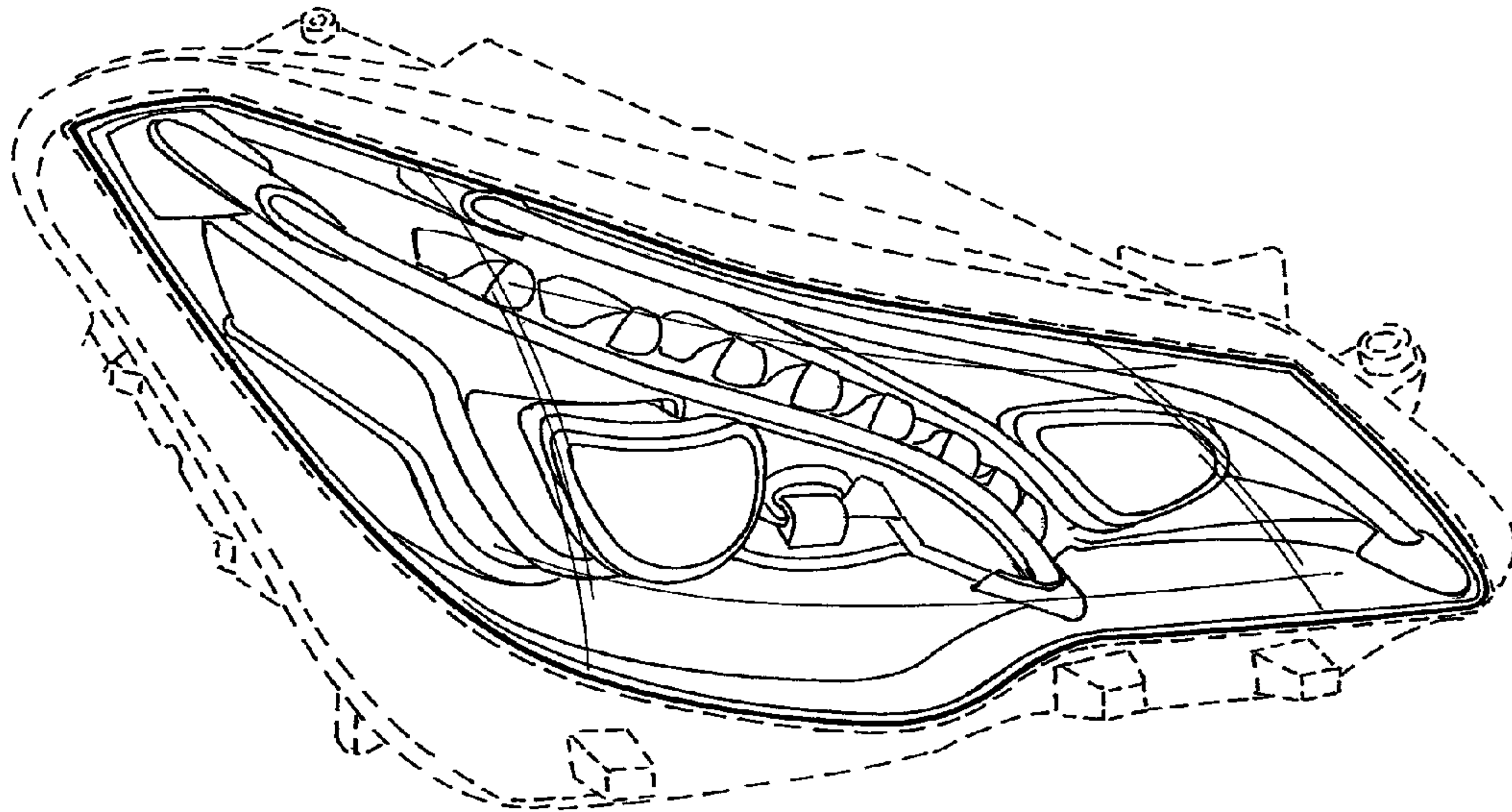

FIG. 5

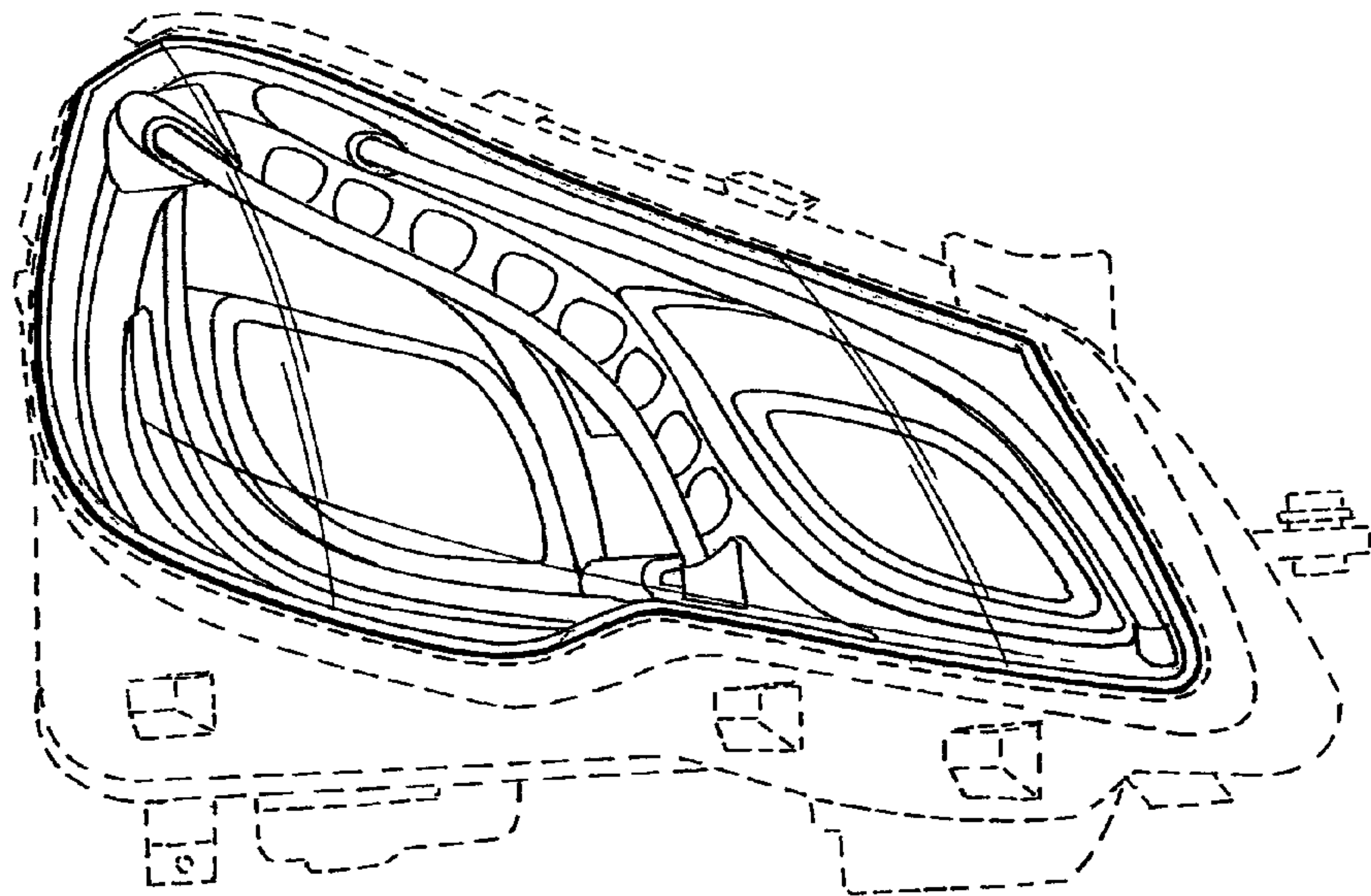

FIG. 6

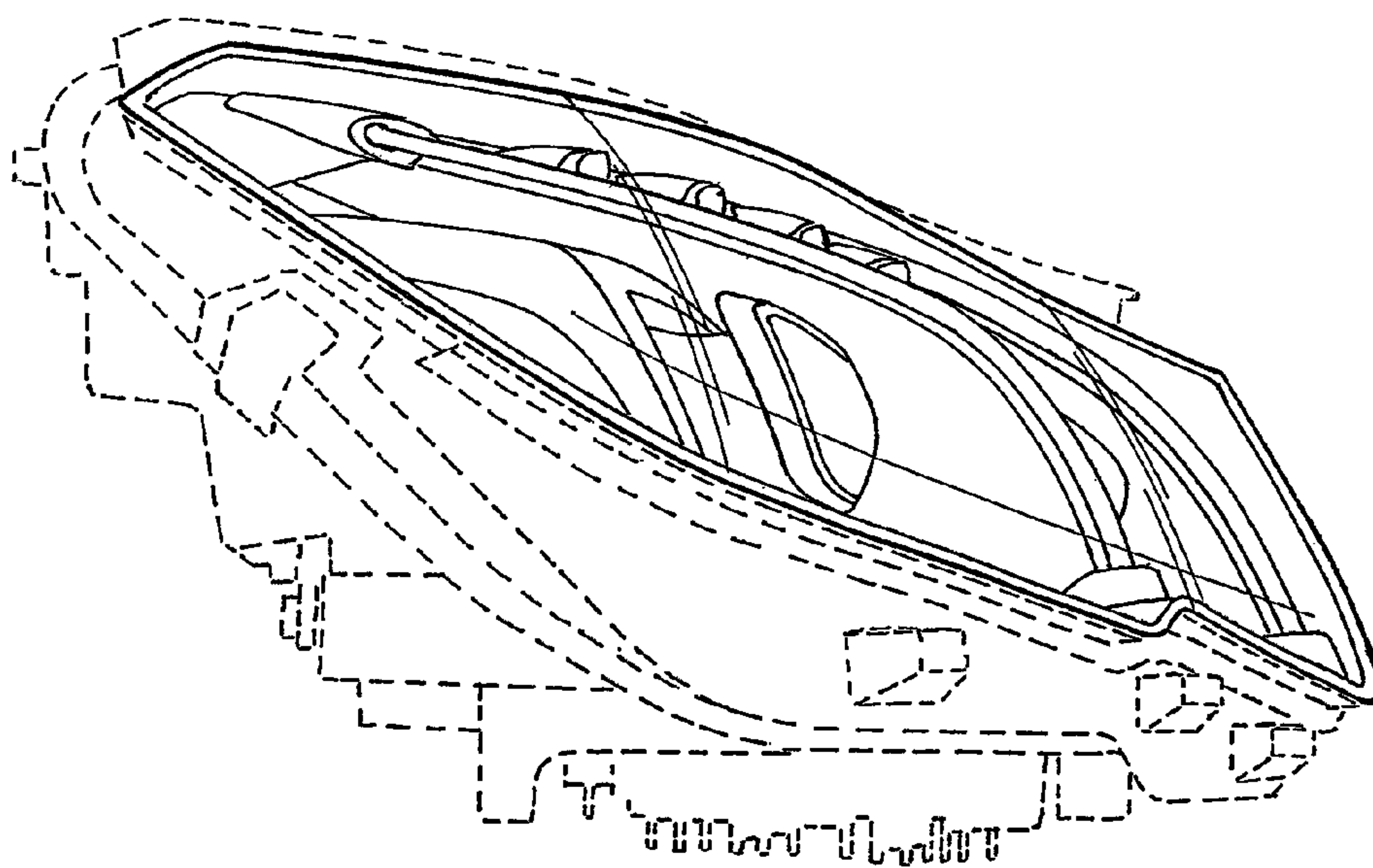

FIG. 7

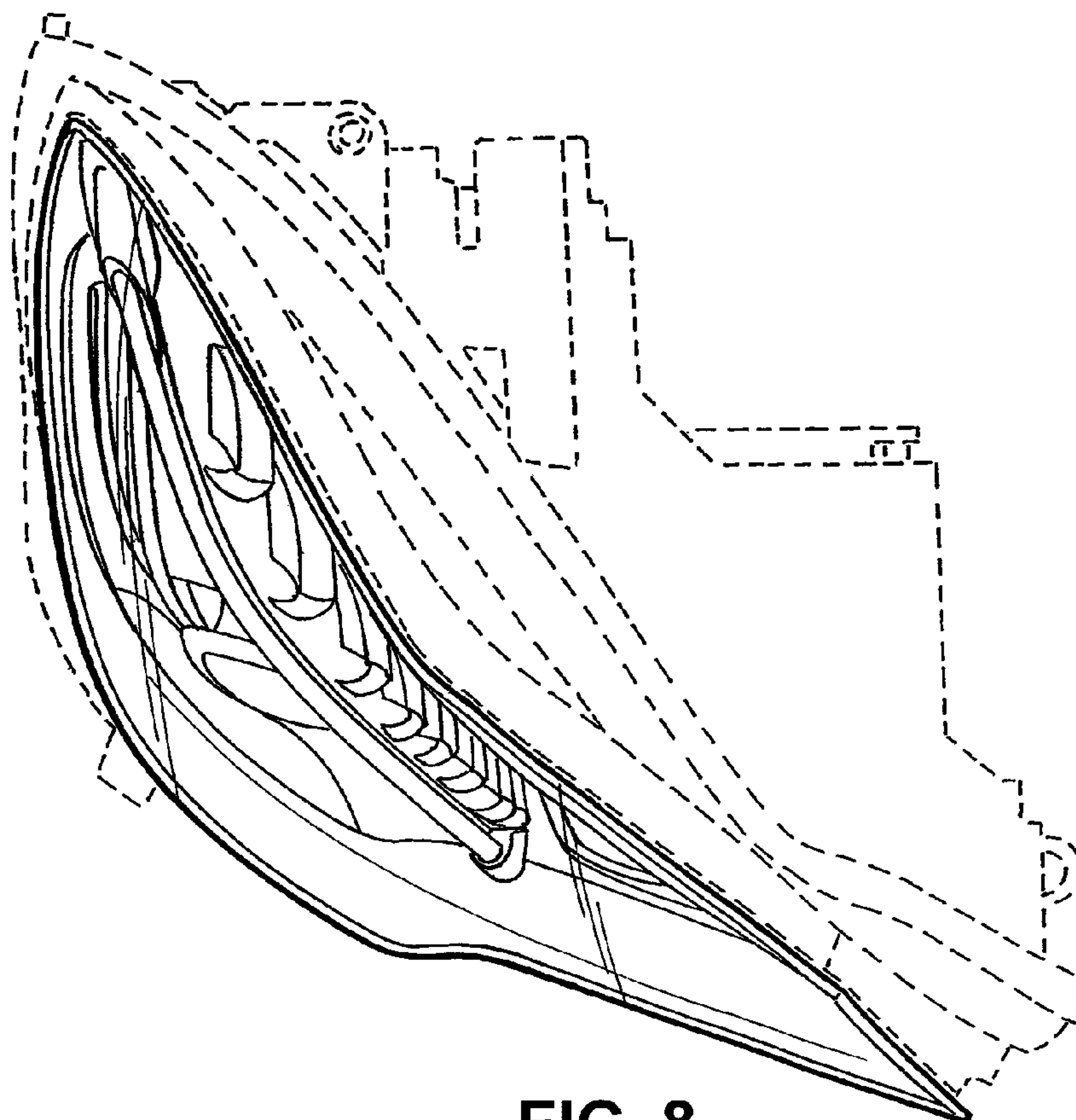

FIG. 8