



US00D691282S

(12) **United States Design Patent**
Motadel et al.

(10) **Patent No.:** **US D691,282 S**
(45) **Date of Patent:** **** Oct. 8, 2013**

- (54) **PIPETTE TIP**
- (71) Applicant: **Biotix, Inc.**, San Diego, CA (US)
- (72) Inventors: **Arta Motadel**, San Diego, CA (US);
Peter Paul Blaszcak, San Diego, CA (US);
Judy Bowman, San Diego, CA (US)
- (73) Assignee: **Biotix, Inc.**, San Diego, CA (US)
- (**) Term: **14 Years**
- (21) Appl. No.: **29/447,034**
- (22) Filed: **Feb. 28, 2013**

Related U.S. Application Data

- (62) Division of application No. 29/416,179, filed on Mar. 19, 2012.
- (51) **LOC (9) Cl.** **24-02**
- (52) **U.S. Cl.**
USPC **D24/222**
- (58) **Field of Classification Search**
USPC D24/216, 222-226, 231, 232, 186,
D24/169, 108, 112-115, 117, 121, 127, 130;
D10/81; 422/521, 501-503; 73/863.32,
73/864.01, 864.16, 864.17, 864.14, 864.21;
436/180; D9/690, 724
See application file for complete search history.

(56) **References Cited**

U.S. PATENT DOCUMENTS

- D256,052 S * 7/1980 De Vaughn D24/222
- D300,561 S * 4/1989 Asa et al. D24/112
- 5,660,797 A * 8/1997 Jarvimaki 422/525

- D384,418 S * 9/1997 Torti et al. D24/222
- 6,566,145 B2 * 5/2003 Brewer 436/178
- 7,794,664 B2 * 9/2010 Pelletier et al. 422/400
- 8,105,555 B2 * 1/2012 Lahti 422/526
- 2006/0177352 A1 * 8/2006 Ziegmann et al. 422/100

* cited by examiner

Primary Examiner — Anhdao Doan

(74) *Attorney, Agent, or Firm* — Grant Anderson LLP

(57) **CLAIM**

The ornamental design for a pipette tip, as shown and described.

DESCRIPTION

FIG. 1 is a perspective view of an embodiment of a pipette tip; FIG. 2 is a front view thereof; FIG. 3 is a side view thereof; FIG. 4 is a top view thereof; FIG. 5 is a bottom view thereof; FIG. 6 is a side view thereof with a broken line indicating a vertical cross-section; FIG. 7 is a cross-section view taken along the broken line 7-7 shown in FIG. 6; FIG. 8 is an enlarged cross-section view of the pipette tip region indicated by a broken line circle in FIG. 7; FIG. 9 is a side view thereof with broken lines indicating horizontal cross-sections; FIG. 10 is a cross-section view taken along broken line 10-10; FIG. 11 is a cross-section view taken along broken line 11-11; and, FIG. 12 is a cross-section view taken along broken line 12-12. The broken lines are included for the purposes of illustrating unclaimed portions of the pipette tip and form no part of the claimed design.

1 Claim, 6 Drawing Sheets

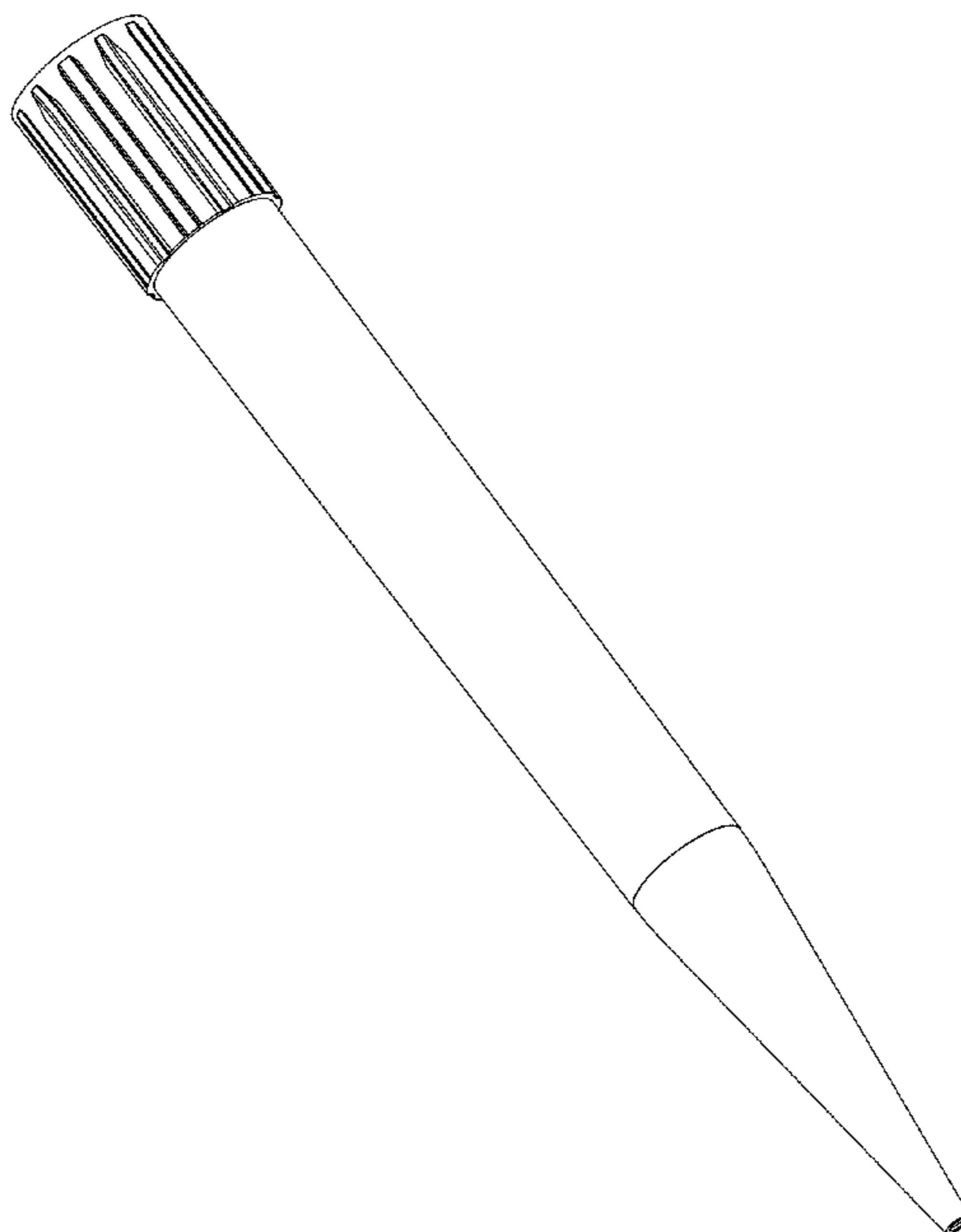

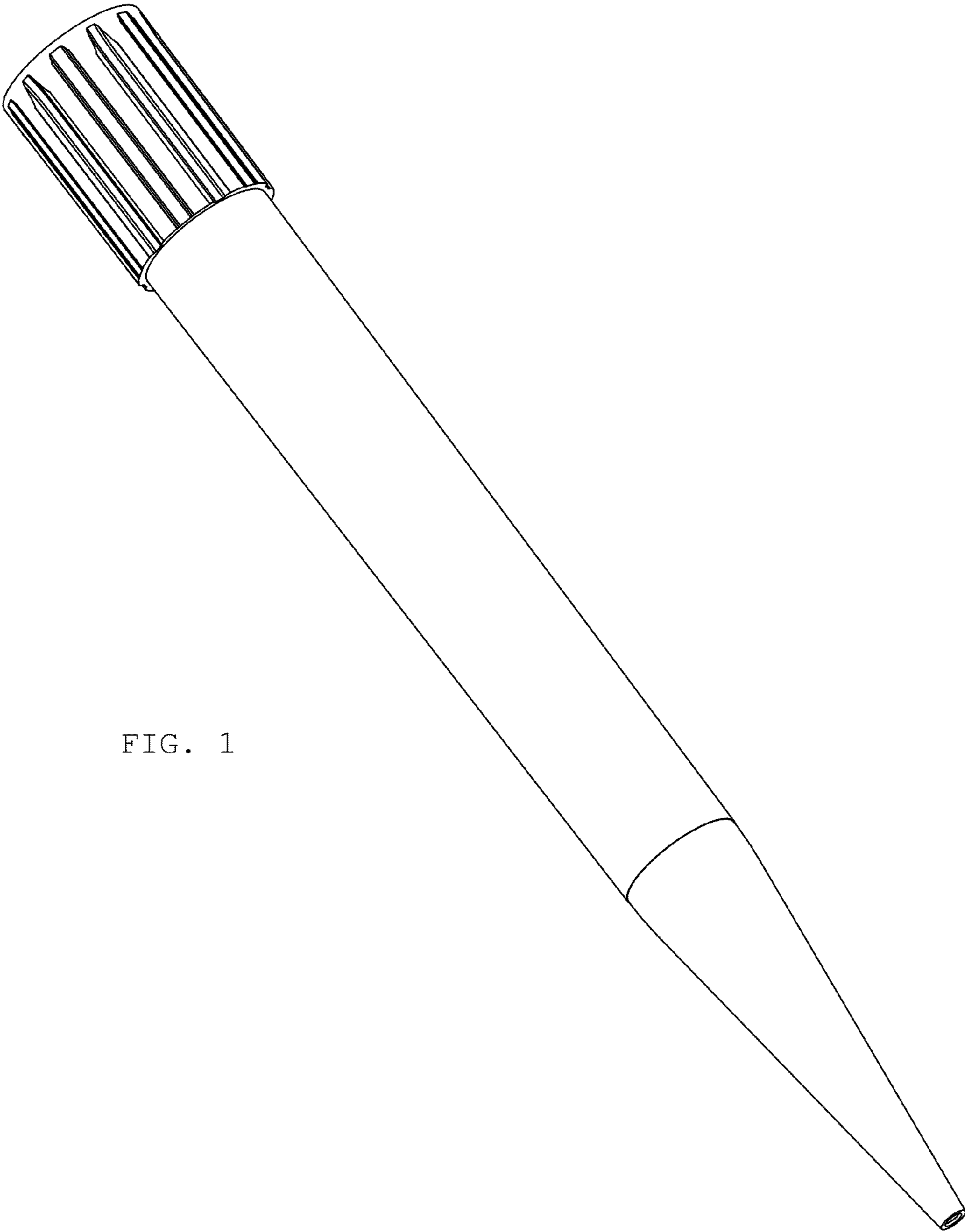

FIG. 1

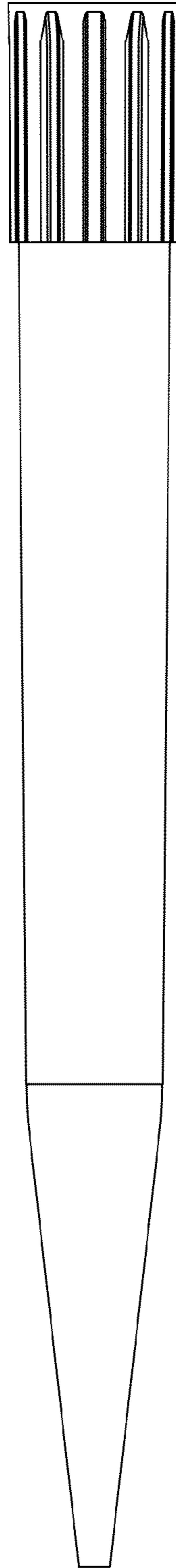

FIG. 2

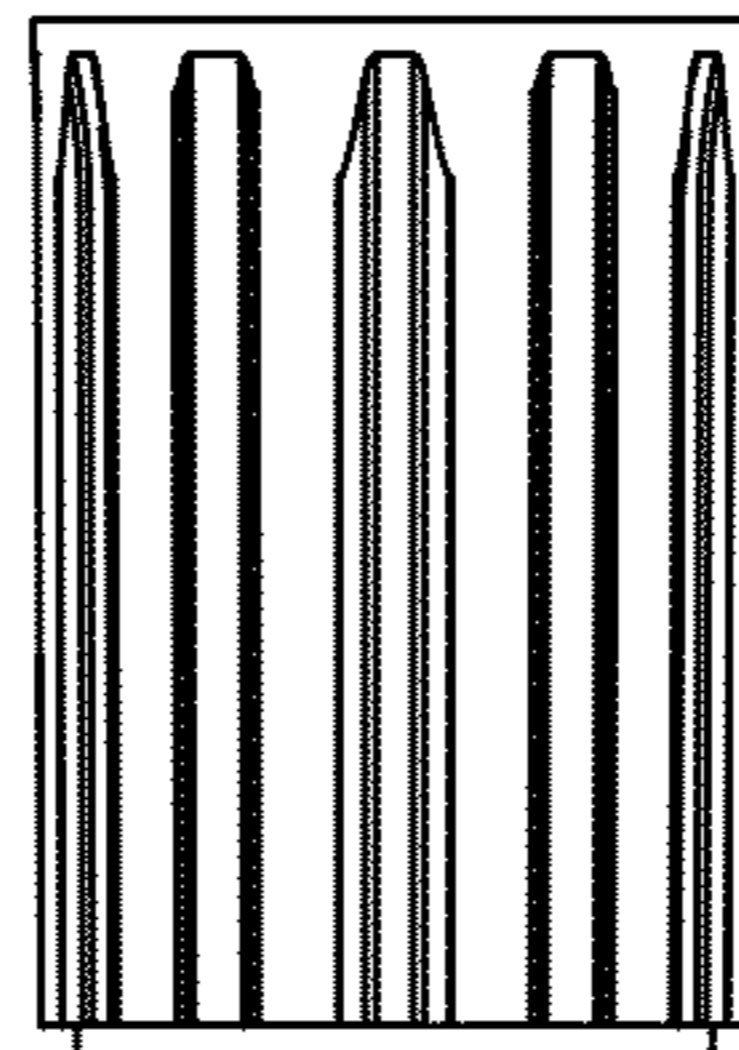
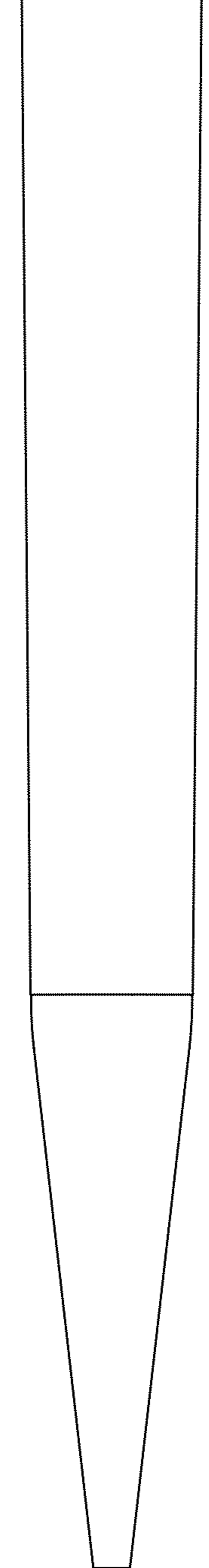

FIG. 3



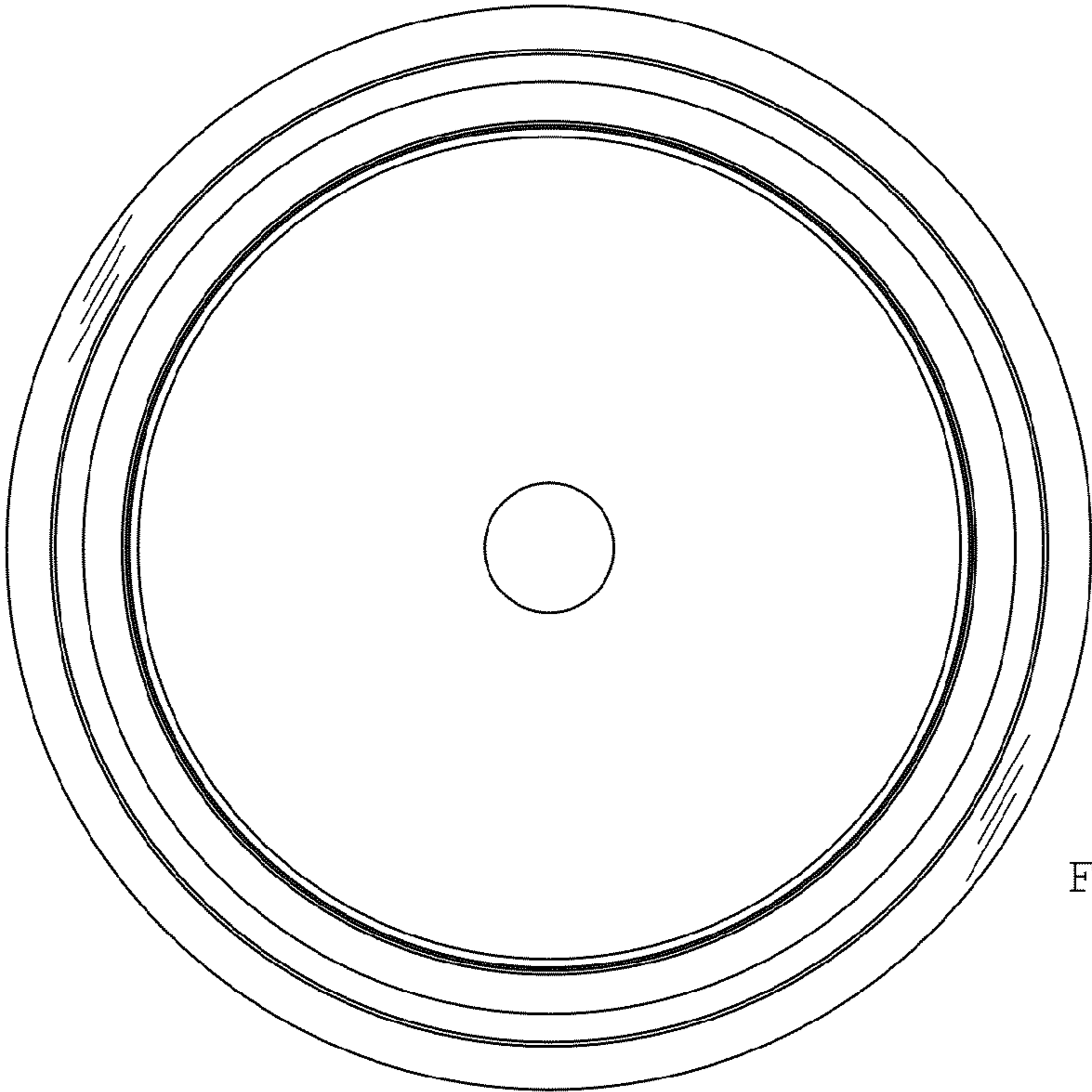

FIG. 4

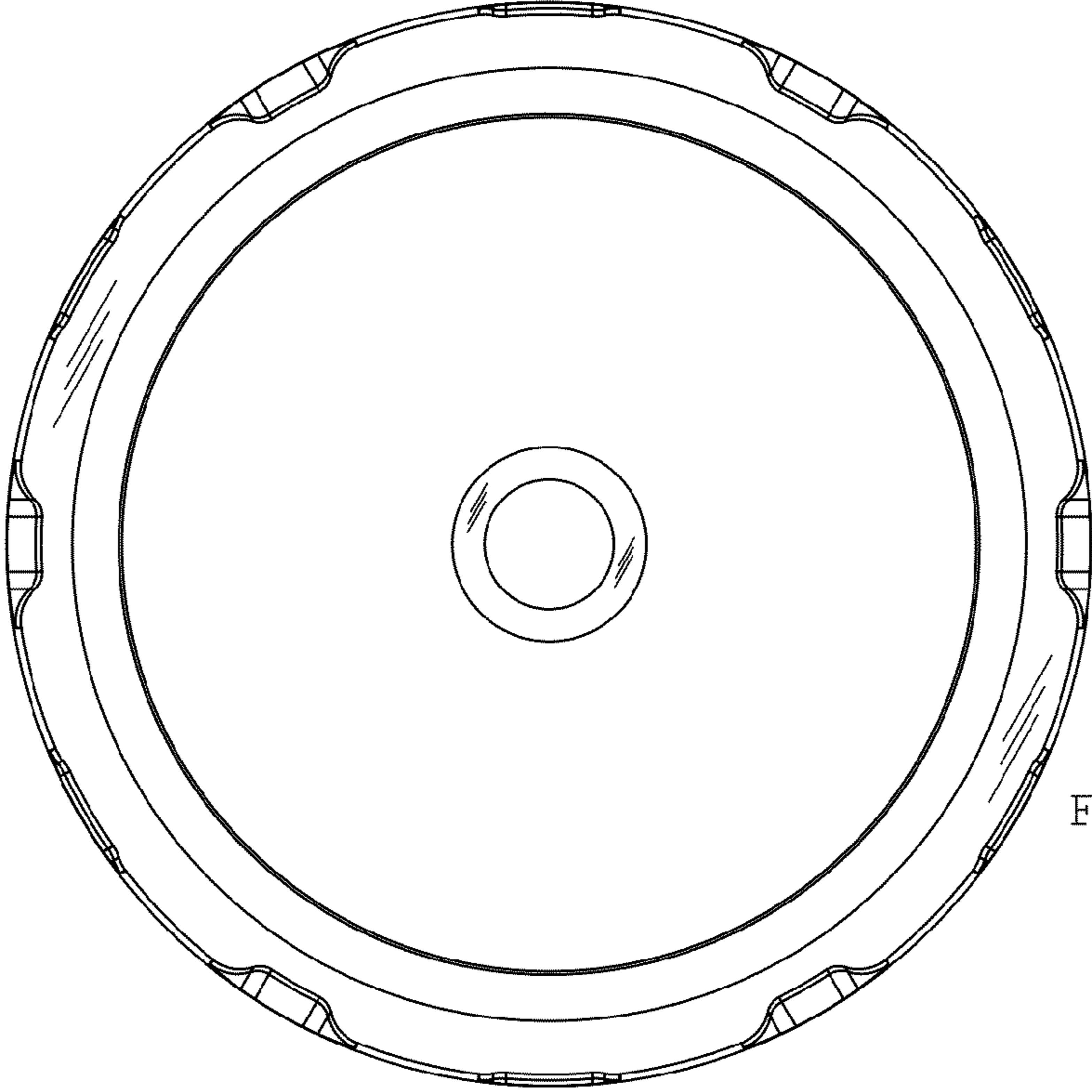
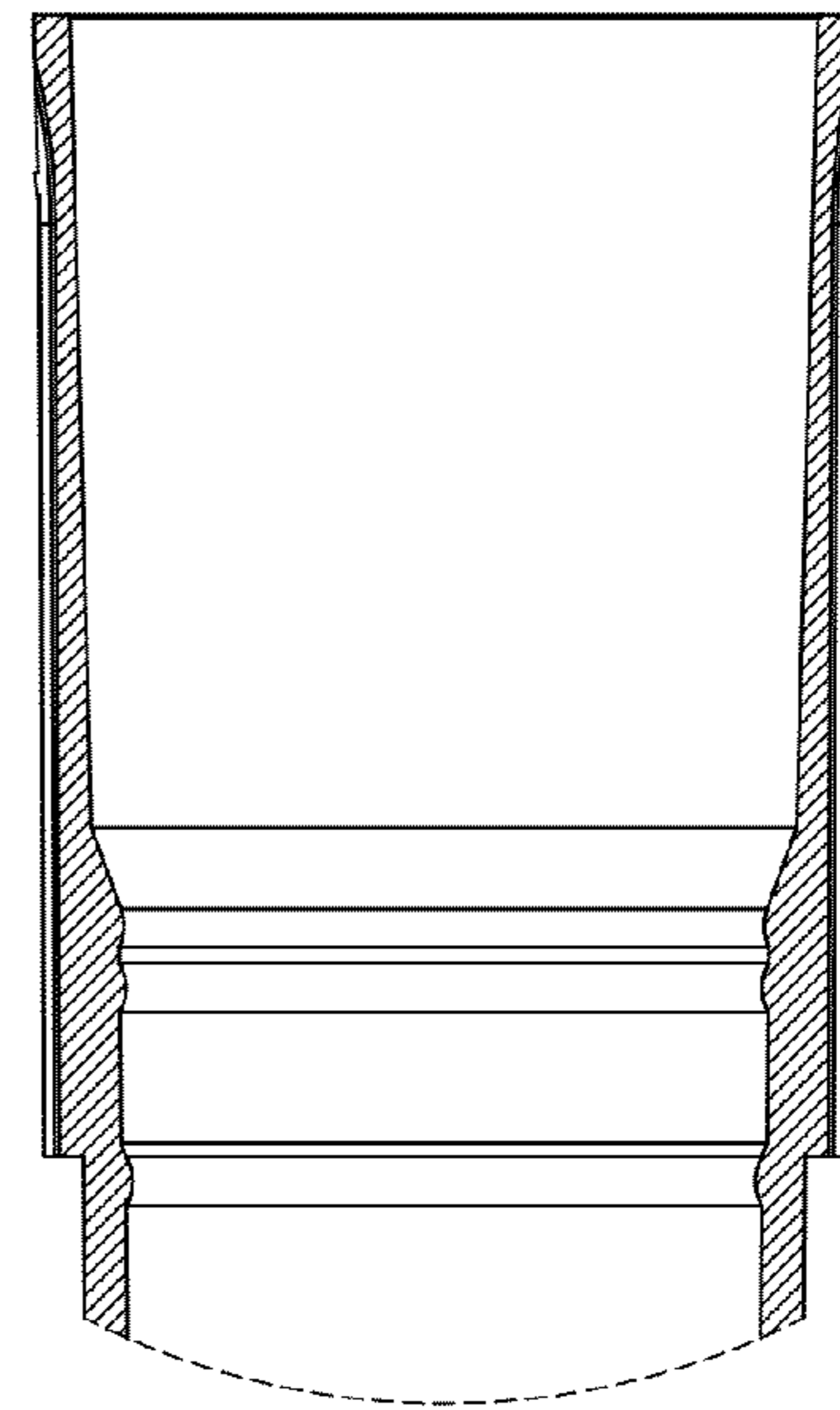
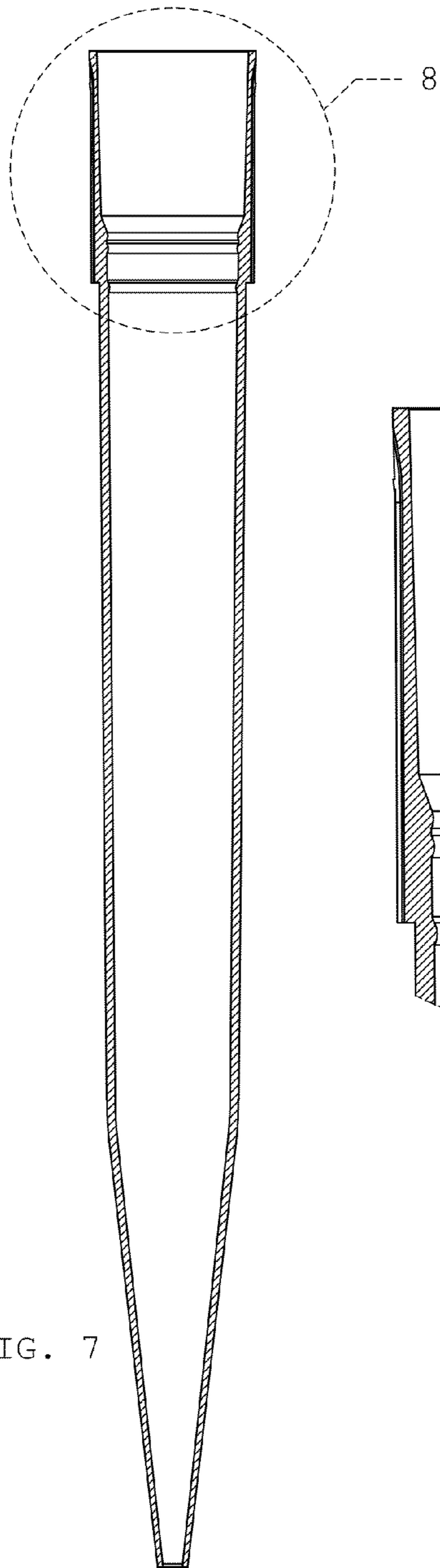
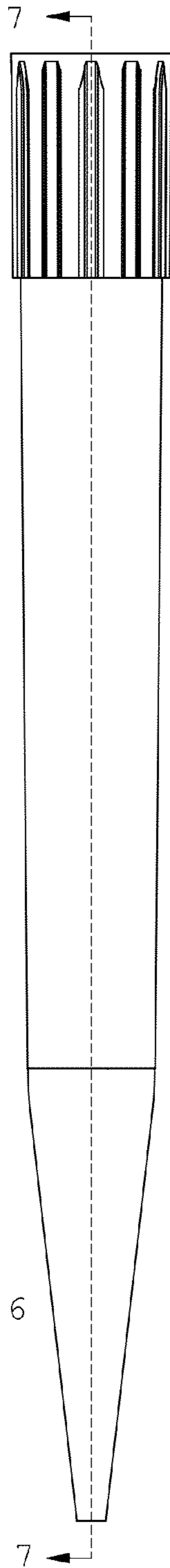

FIG. 5



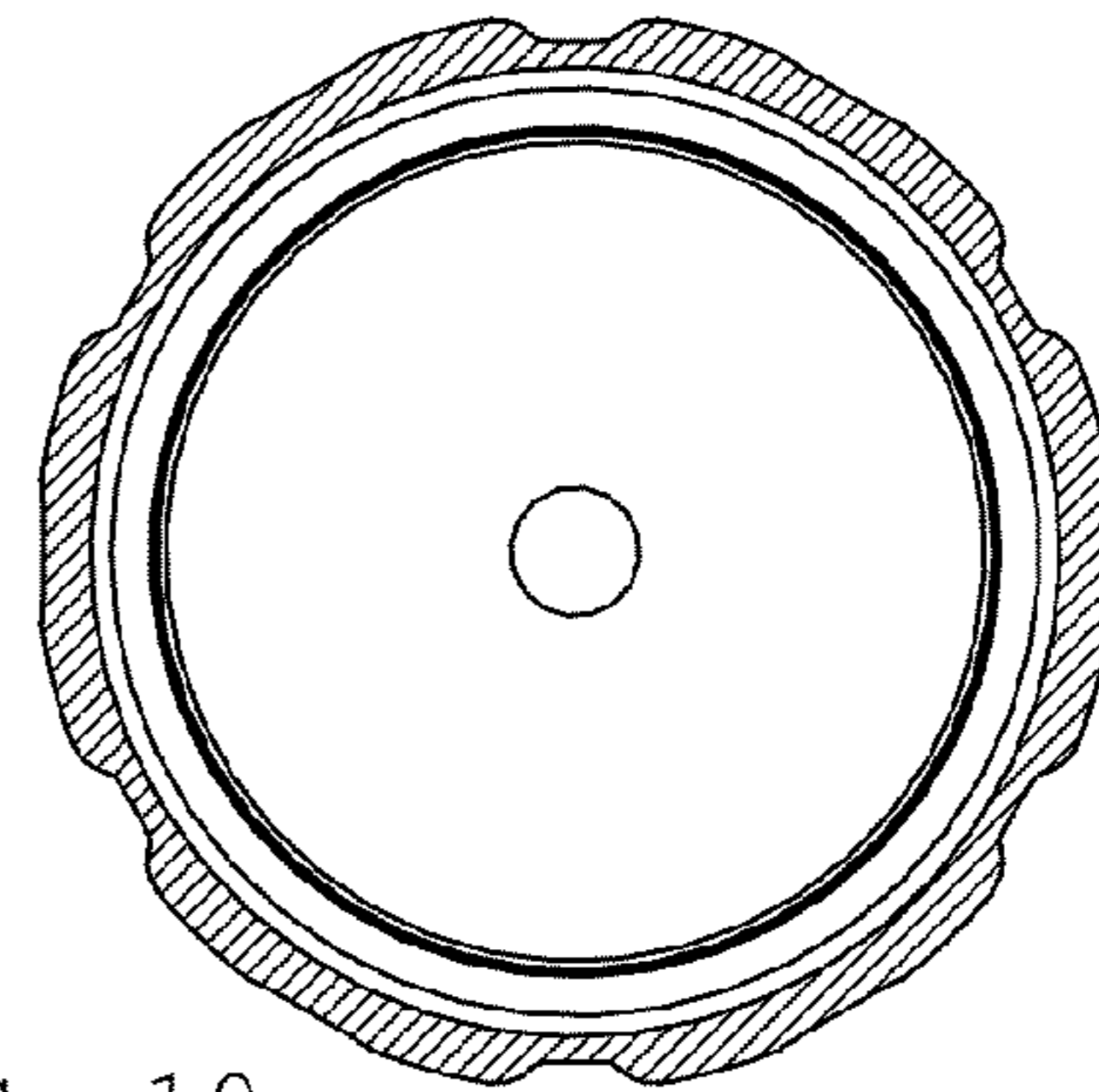
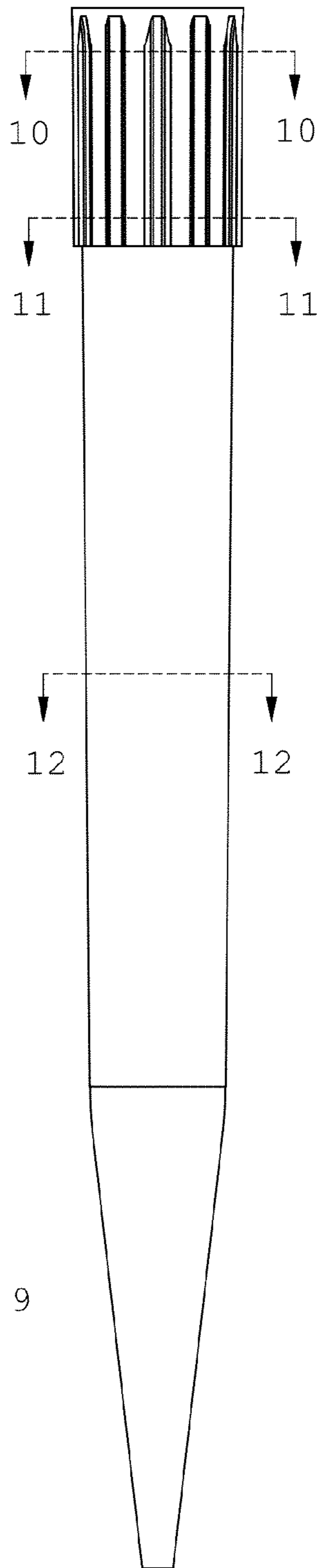

FIG. 10

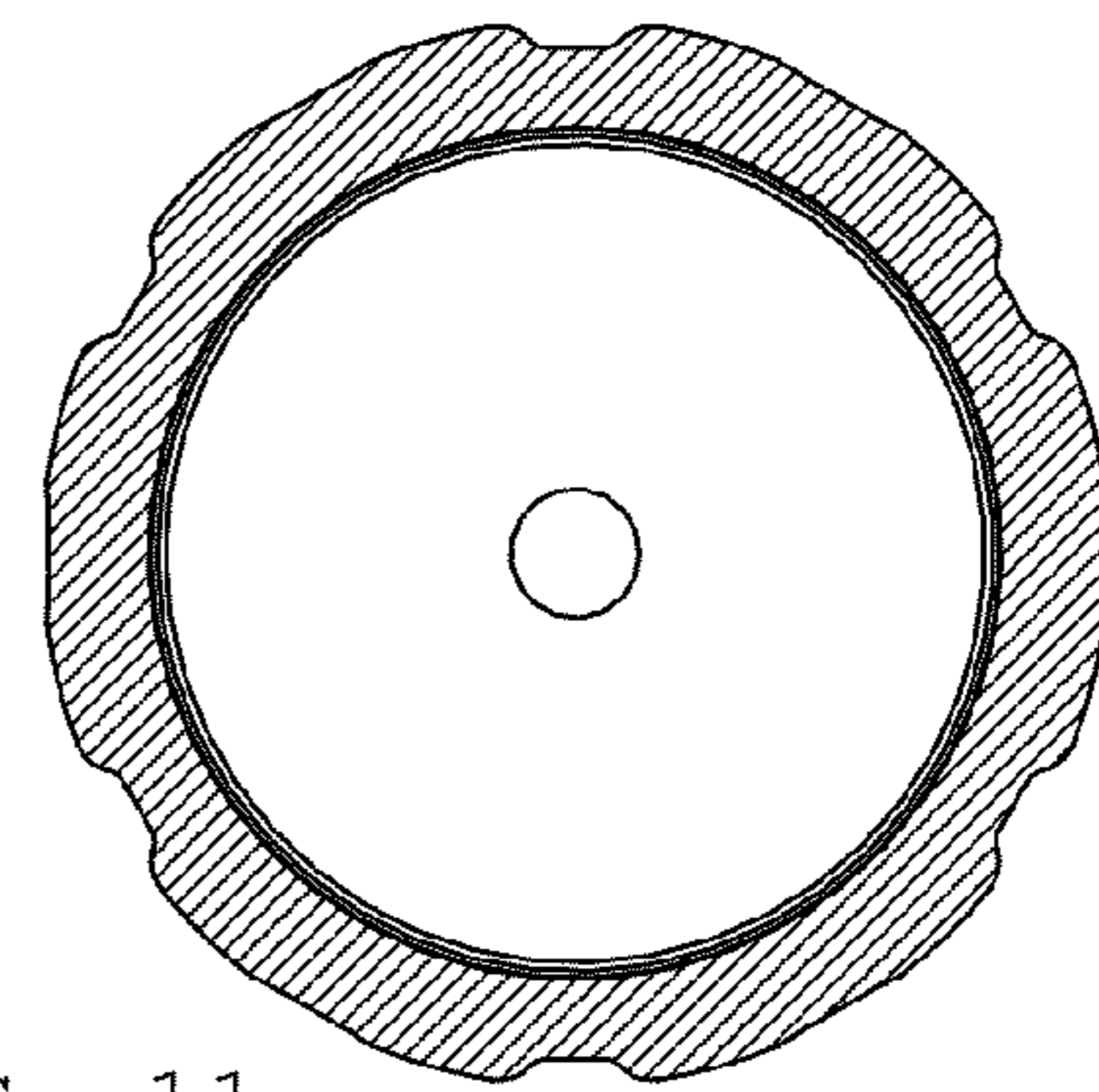

FIG. 11

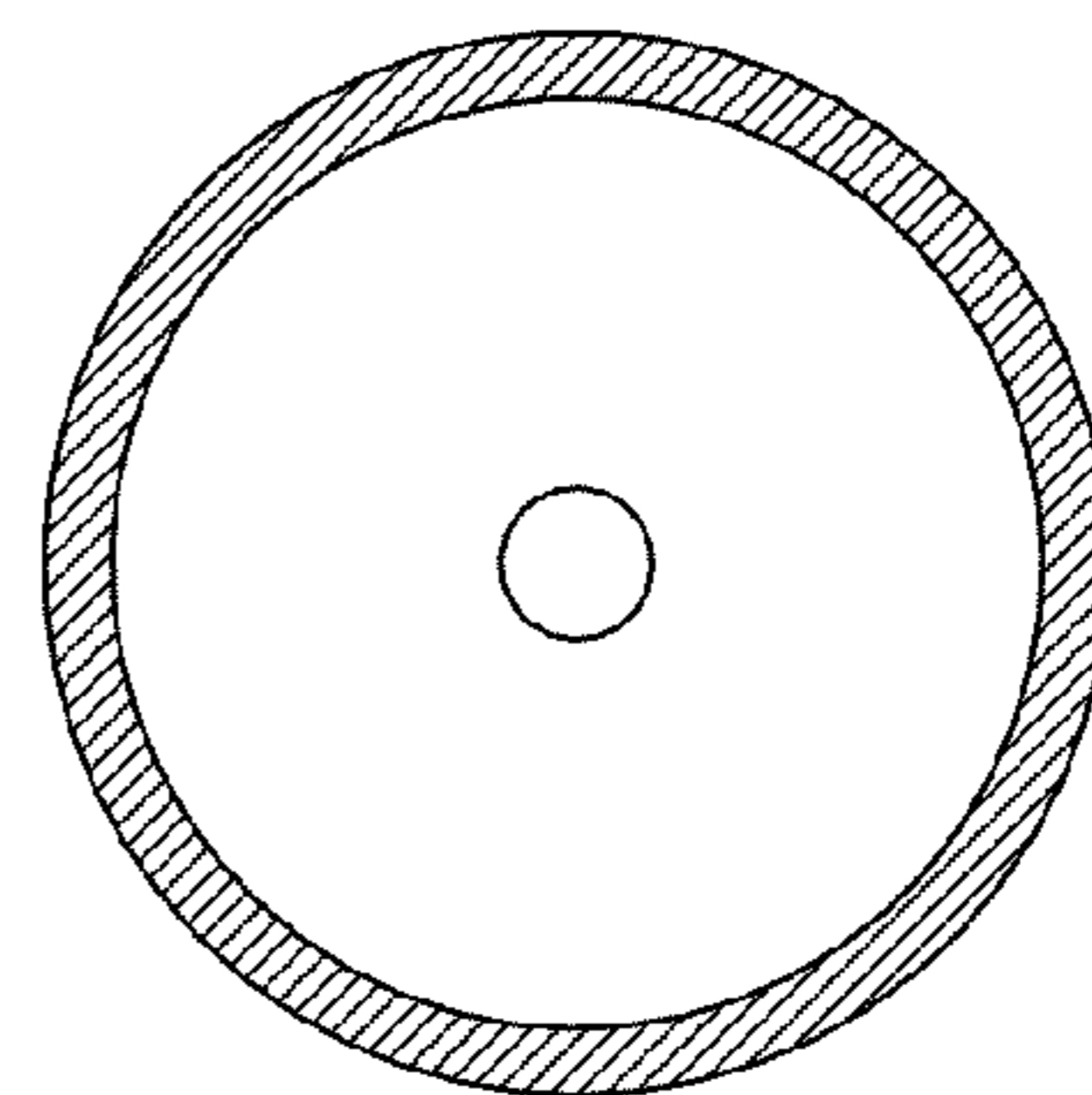

FIG. 12