



US00D691032S

(12) **United States Design Patent**  
**Chen**

(10) **Patent No.:** **US D691,032 S**

(45) **Date of Patent:** **\*\* Oct. 8, 2013**

(54) **CABLE HOLDER**

(76) Inventor: **Kevin F. Chen**, Anaheim, CA (US)

(\*\*) Term: **14 Years**

(21) Appl. No.: **29/411,233**

(22) Filed: **Jan. 18, 2012**

(51) **LOC (9) Cl.** ..... **08-08**

(52) **U.S. Cl.**  
USPC ..... **D8/396**

(58) **Field of Classification Search**  
USPC ..... D8/354, 356, 371, 394-396; D19/65,  
D19/86; D24/128; 248/74.2, 215, 227.1,  
248/49, 300, 301, 316.7, 51, 489; 24/570,  
24/3.12; D32/61; D11/78.1  
See application file for complete search history.

(56) **References Cited**

**U.S. PATENT DOCUMENTS**

2,979,554	A *	4/1961	Maitland	174/138 G
3,106,994	A *	10/1963	Scott	403/231
D228,738	S *	10/1973	Abrizzi	D8/394
D248,347	S *	7/1978	McCollum	D6/552
D279,959	S *	8/1985	Nimmo et al.	D8/396
4,876,810	A *	10/1989	Piana et al.	40/316
D309,255	S *	7/1990	Karow, Jr.	D8/395
D309,280	S *	7/1990	Balfanz-Lee	D11/215
5,275,282	A *	1/1994	Ross et al.	206/389
5,299,367	A *	4/1994	Johnson et al.	34/95
5,407,109	A *	4/1995	Zuckerman	223/85
5,820,095	A *	10/1998	Stone	248/316.7
D406,051	S *	2/1999	Ross	D8/395
D426,577	S *	6/2000	Mackey et al.	D19/89
D478,738	S *	8/2003	Workman	D6/418
D510,857	S *	10/2005	Minor et al.	D8/396

7,111,812	B2 *	9/2006	Shannon et al.	248/230.7
D537,331	S *	2/2007	Hill	D8/395
D571,648	S *	6/2008	Rieder	D8/395
D592,303	S *	5/2009	Chesnin	D24/128
D622,585	S *	8/2010	Walker, Jr.	D8/396
D628,050	S *	11/2010	Petersen et al.	D8/356
D647,788	S *	11/2011	Weaver et al.	D8/396
D653,100	S *	1/2012	Chen	D8/356
D665,449	S *	8/2012	Guirlinger	D19/83
D675,856	S *	2/2013	Yiannaki	D6/606
2008/0295835	A1 *	12/2008	Han et al.	128/204.18
2010/0127472	A1 *	5/2010	Winefordner et al.	280/276

\* cited by examiner

*Primary Examiner* — John Windmuller

(74) *Attorney, Agent, or Firm* — C. G. Mersereau; Nikolai & Mersereau, P.A.

(57) **CLAIM**

I claim the ornamental design for a cable holder, as shown and described.

**DESCRIPTION**

FIG. 1 is a perspective view of a cable holder, showing my new design;  
FIG. 2 is a front elevational view thereof, the rear elevational view being a mirror image thereof;  
FIG. 3 is a left-side elevational view thereof, the right-side elevational view being a mirror image thereof;  
FIG. 4 is a top plan view thereof; and,  
FIG. 5 is a bottom plan view thereof.  
The broken lines showing a cable, desk and additional cable holders in FIG. 1 depict environmental matter and form no part of the claimed design.

**1 Claim, 2 Drawing Sheets**

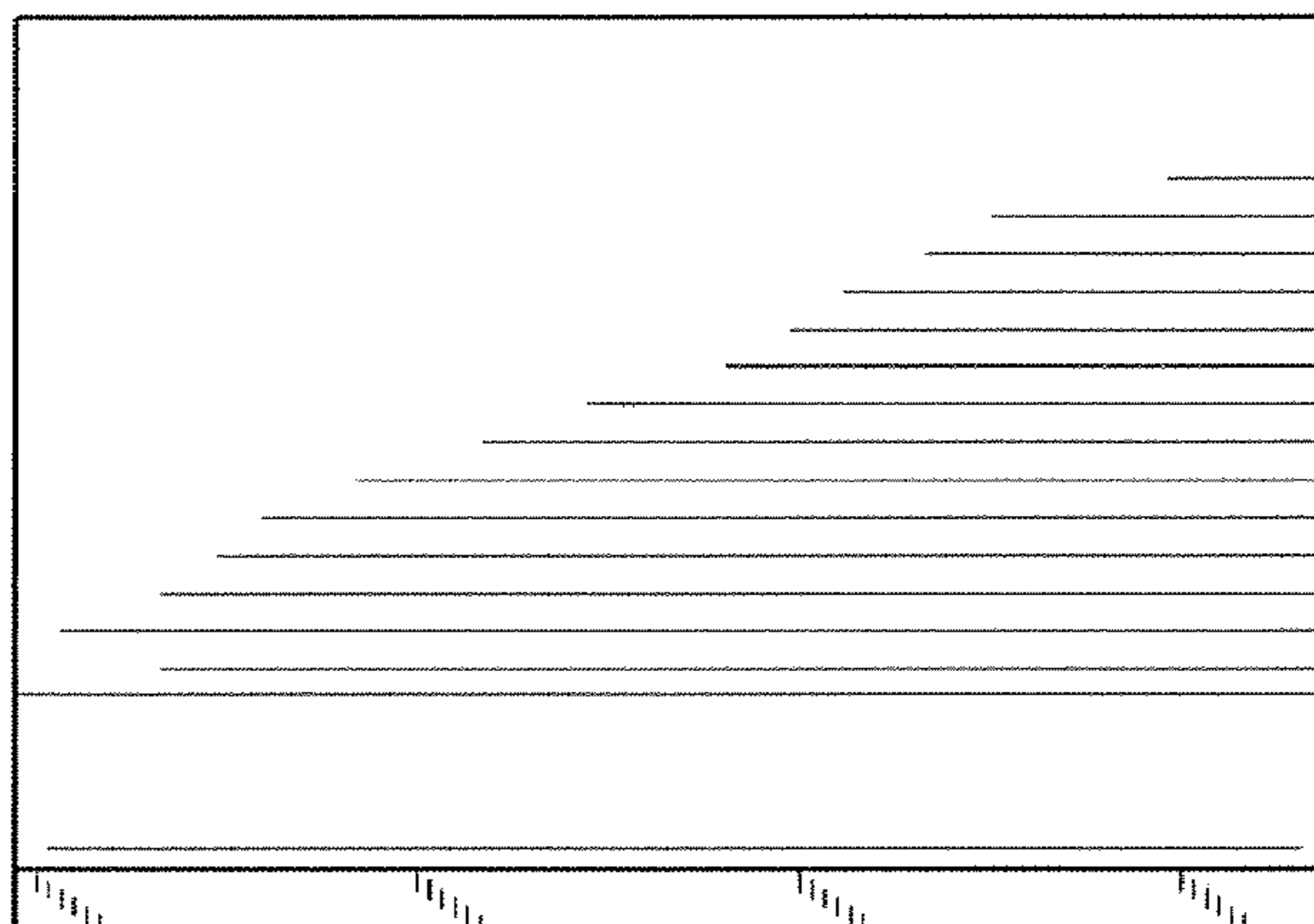
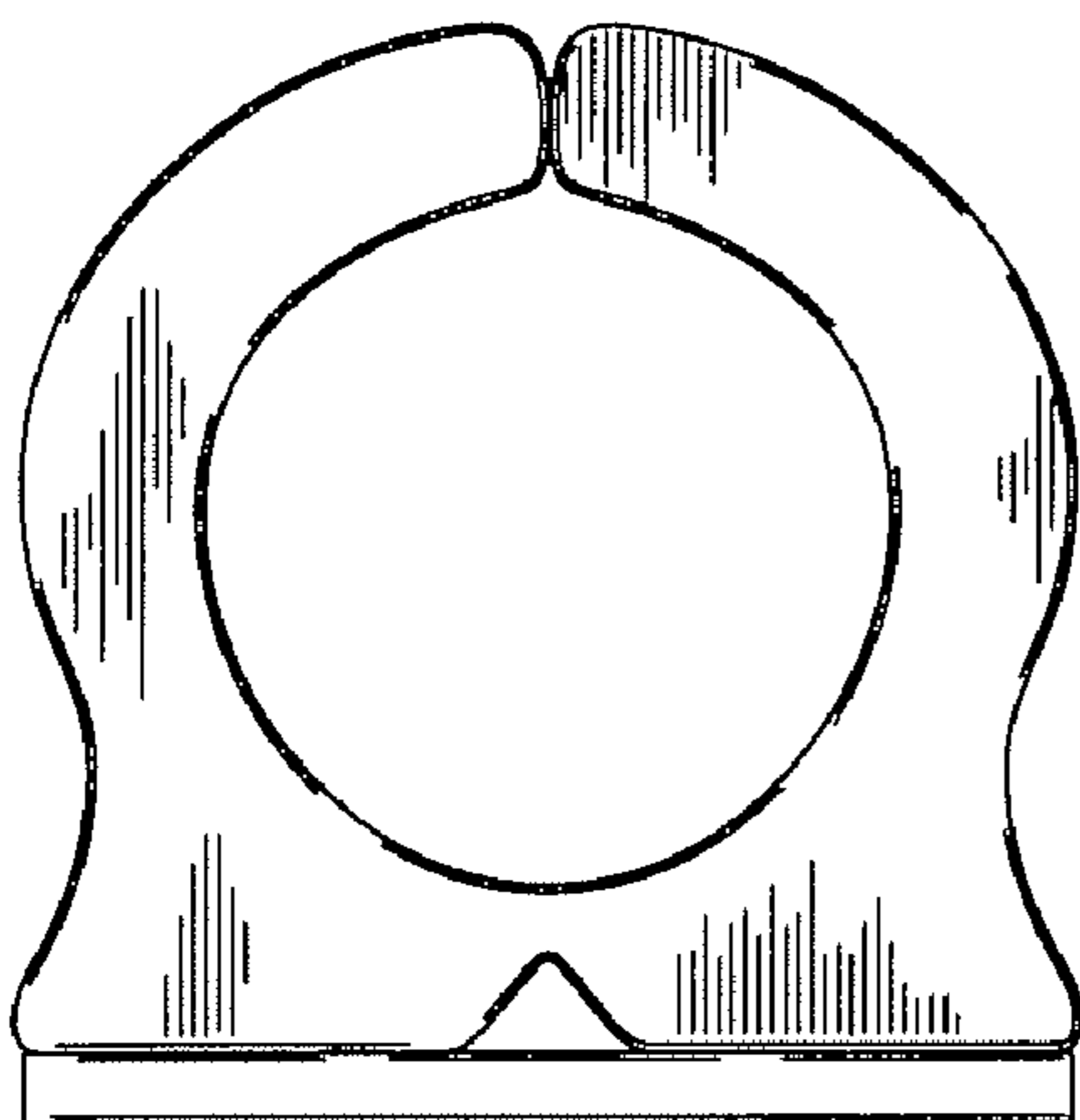

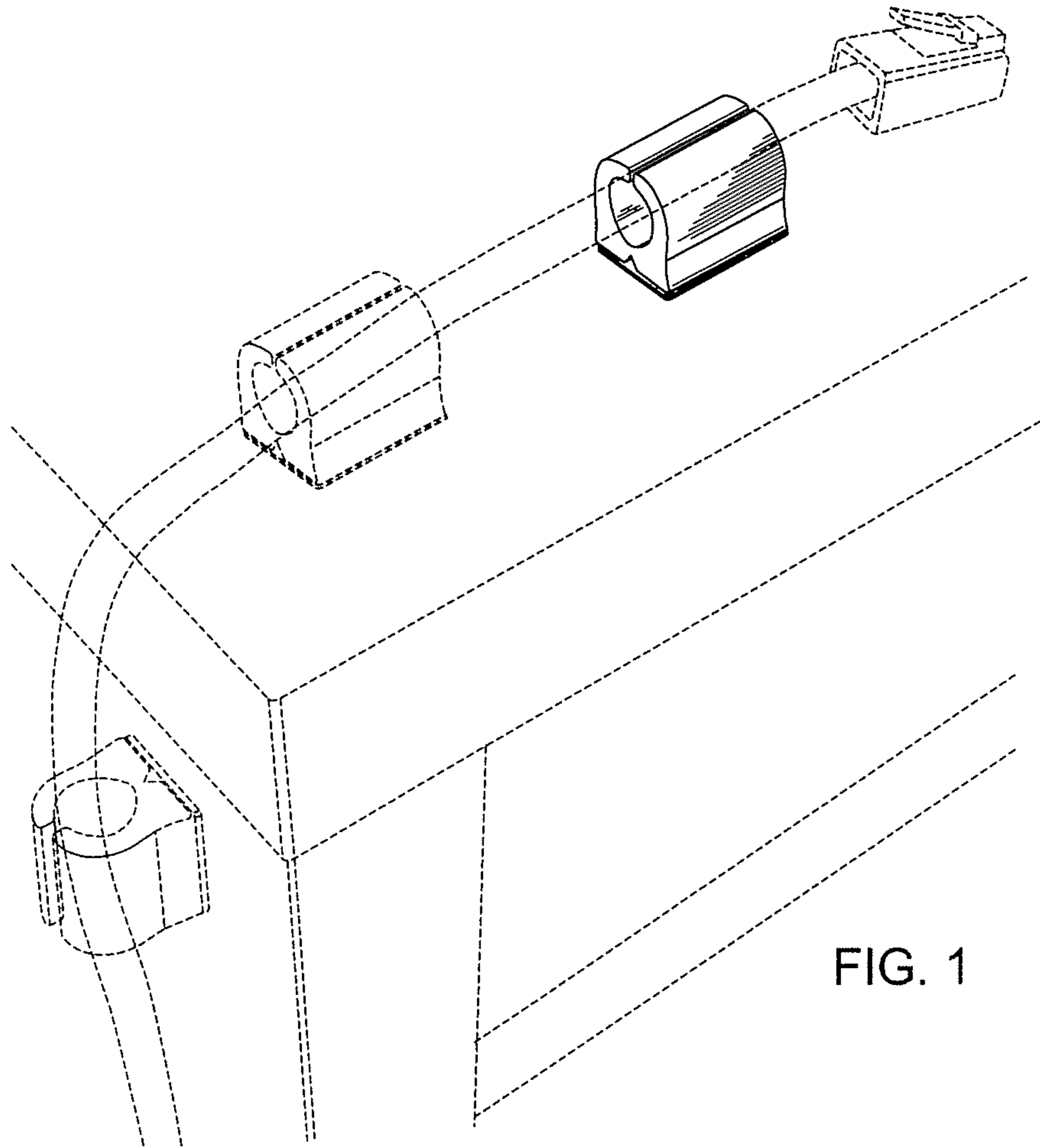

FIG. 1

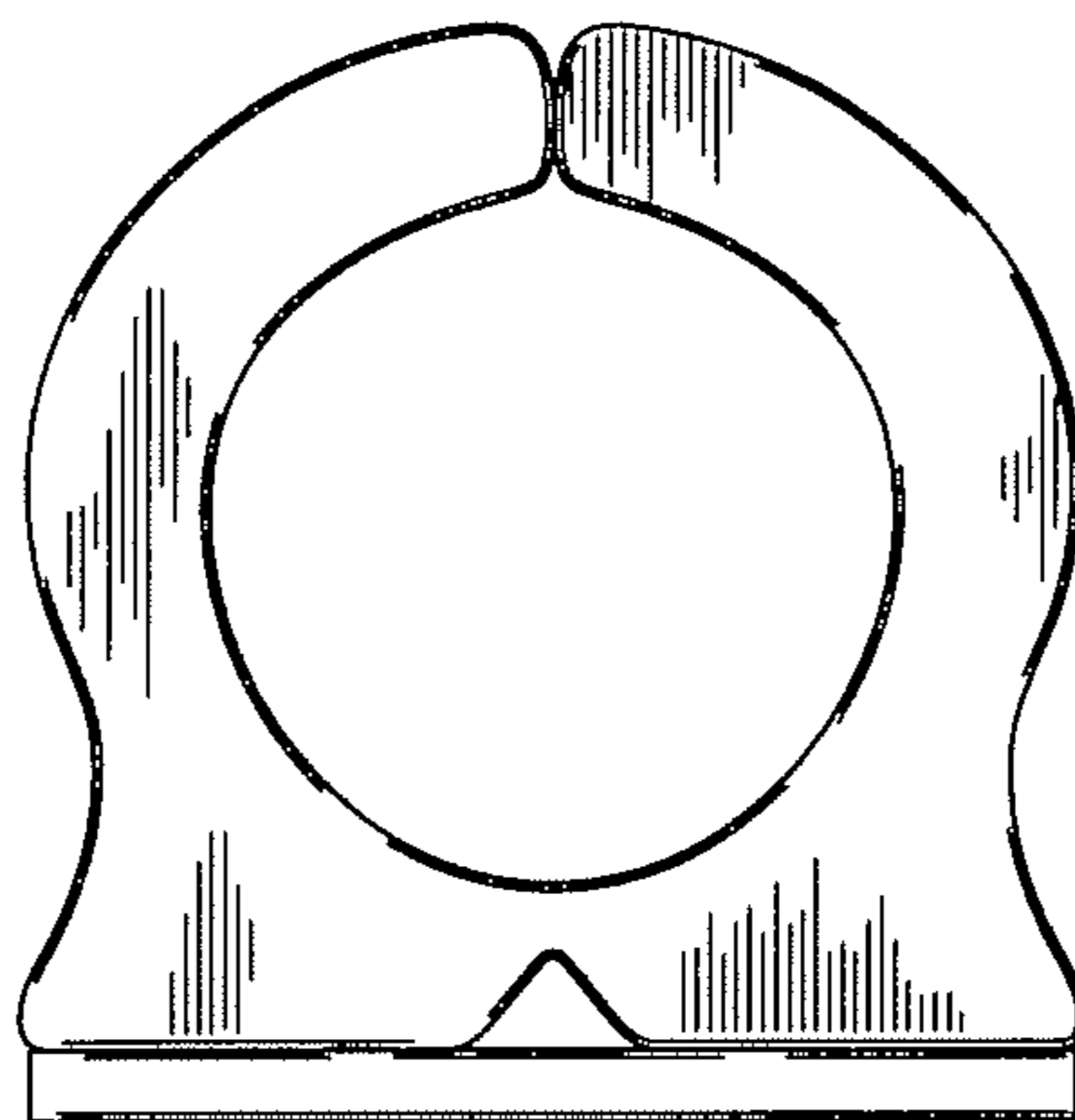

FIG. 2

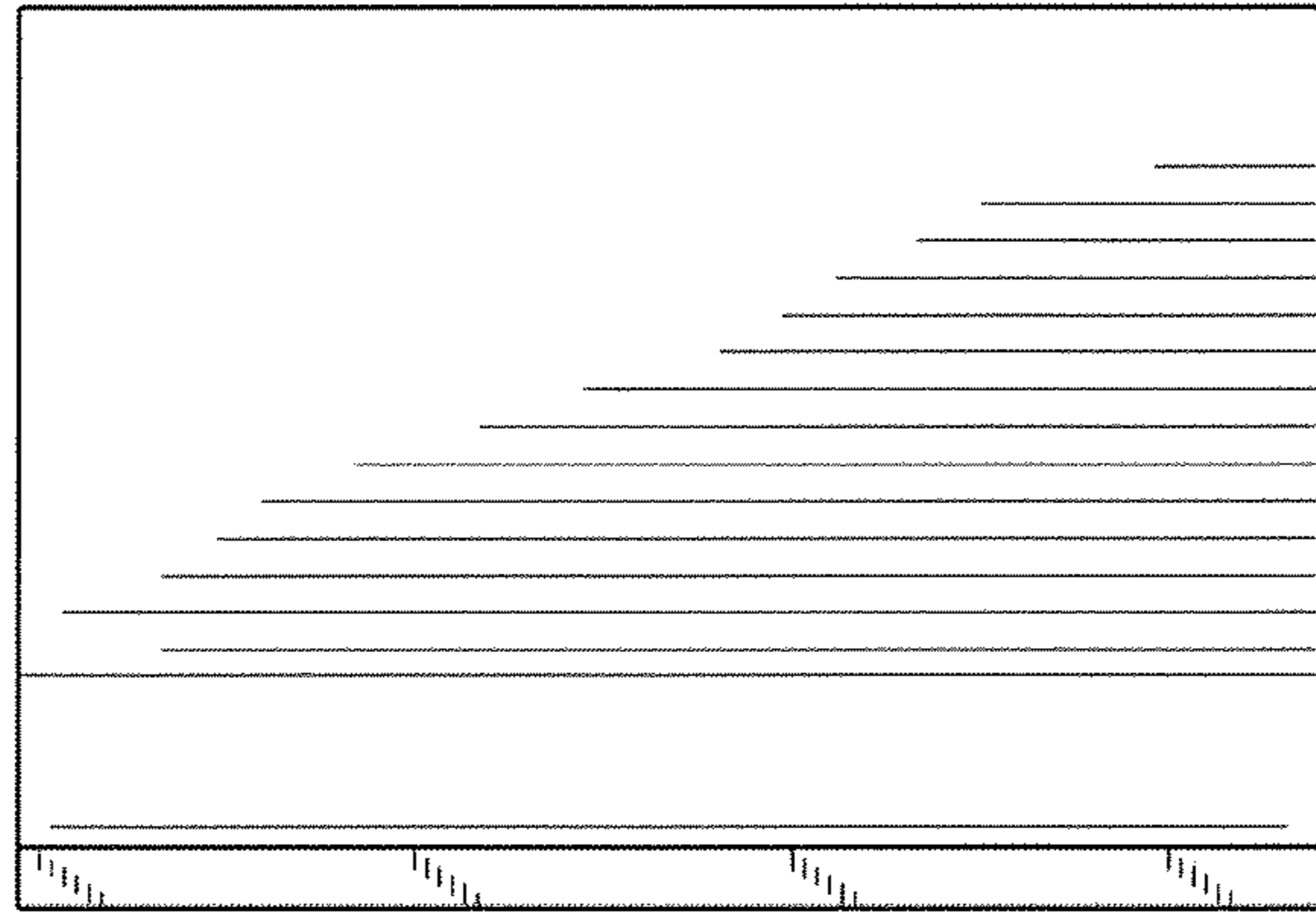

FIG. 3

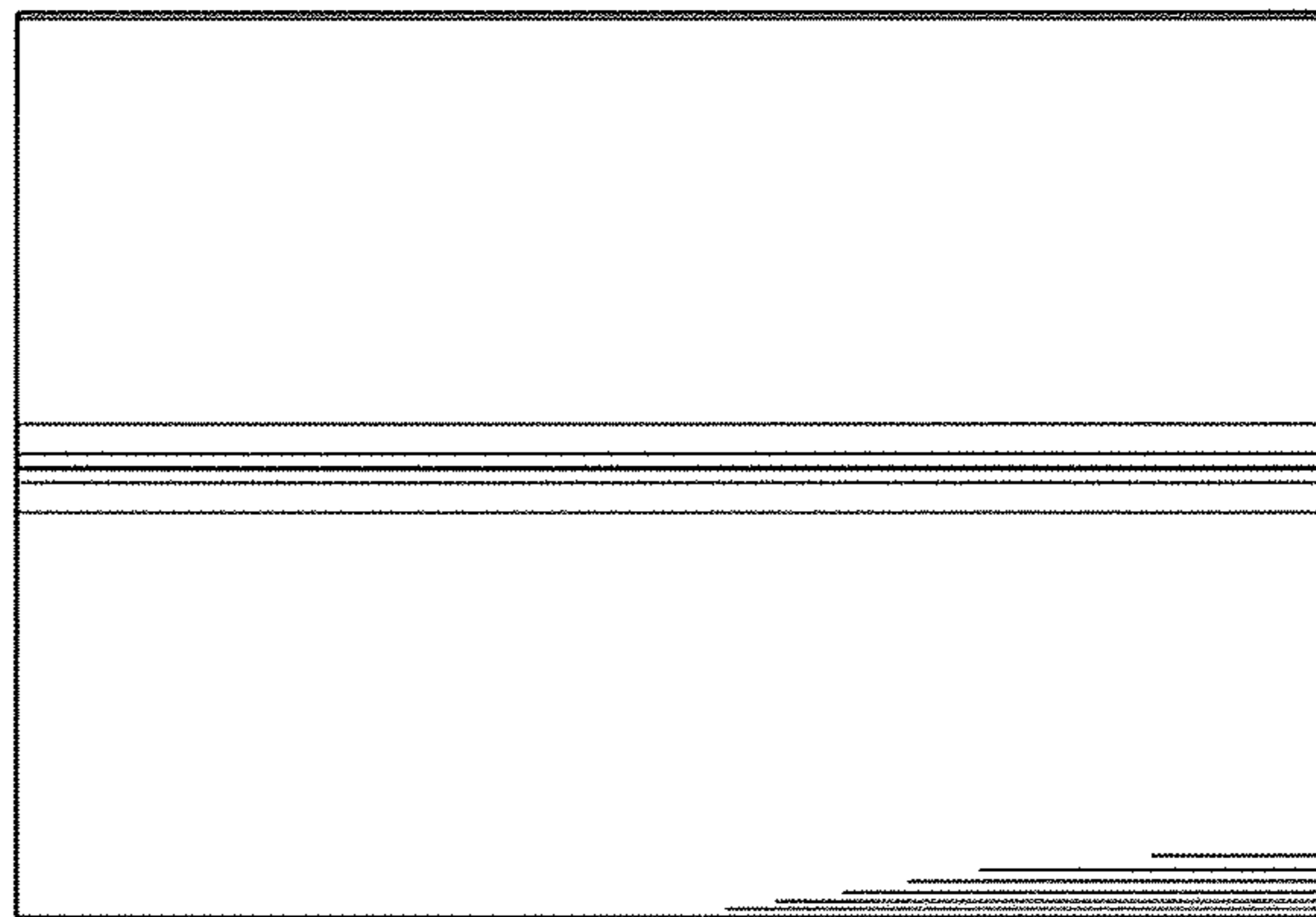

FIG. 4

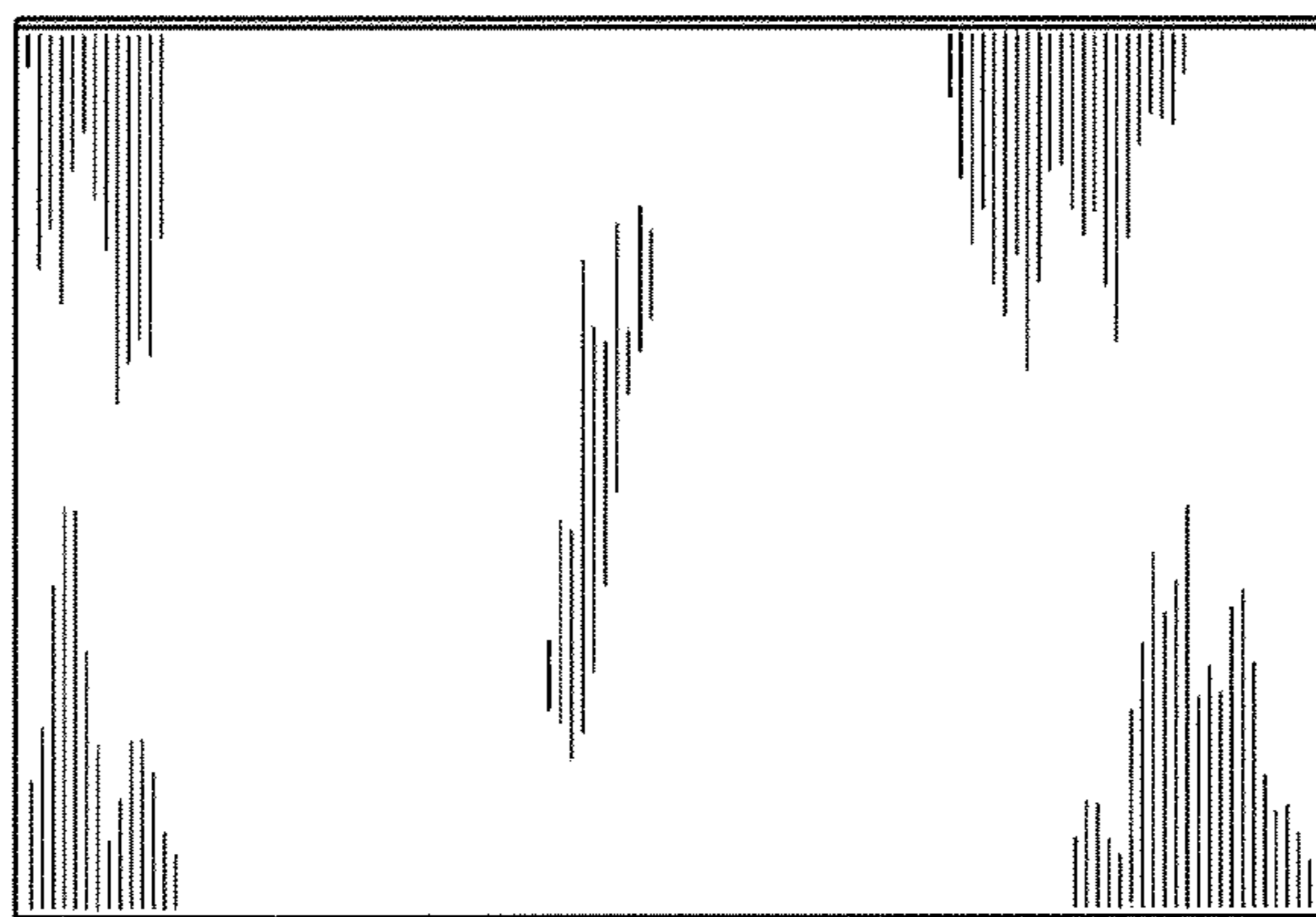

FIG. 5