



US00D690993S

(12) **United States Design Patent**
Im

(10) **Patent No.:** **US D690,993 S**

(45) **Date of Patent:** **** Oct. 8, 2013**

(54) **UTENSIL ACCESSORY**

(71) Applicant: **Kristine Janelle Im**, Mead, CO (US)

(72) Inventor: **Kristine Janelle Im**, Mead, CO (US)

(**) Term: **14 Years**

(21) Appl. No.: **29/436,704**

(22) Filed: **Nov. 8, 2012**

(51) **LOC (9) Cl.** **07-02**

(52) **U.S. Cl.**

USPC **D7/401.2**; D7/642; D7/653; D7/654

(58) **Field of Classification Search**

USPC D4/107, 114; D7/368, 393-395,
D7/401.2, 642-656, 660-664, 669, 675-676,
D7/683, 688-692, 695-696; D8/14-18,
D8/22, 395; D9/630; D19/59, 62; D21/592;
D22/118, 128, 132; 15/167.1; 30/120.1,
30/125, 137, 141-143, 147-150, 322-327,
30/329, 340, 342-344; 43/42.24, 42.53;
416/70 R, 75

See application file for complete search history.

(56) **References Cited**

U.S. PATENT DOCUMENTS

D158,818	S	*	5/1950	Titensky	D7/648
D278,736	S	*	5/1985	Klawitter	D21/592
5,142,811	A	*	9/1992	Freeman	43/42.53
D329,948	S	*	10/1992	Hanner	D4/114
D356,928	S	*	4/1995	Brown et al.	D7/656
D413,355	S	*	8/1999	Cogliano	D19/62
D417,122	S	*	11/1999	Jagger	D7/401.2
5,996,271	A	*	12/1999	Packer	43/42.24
D438,386	S	*	3/2001	Enriquez	D4/107
D451,572	S	*	12/2001	Barker, II	D22/118
6,363,568	B1	*	4/2002	Harrison et al.	15/167.1
D465,703	S	*	11/2002	Matt	D7/643
D474,945	S	*	5/2003	Guodace	D7/656
D476,862	S	*	7/2003	Jagger	D7/645
D477,775	S	*	7/2003	Adams et al.	D8/395

D498,509	S	*	11/2004	Toscano, Jr.	D22/132
D507,941	S	*	8/2005	Tranfaglia et al.	D7/656
D508,381	S	*	8/2005	Tranfaglia et al.	D7/656
D508,382	S	*	8/2005	Tranfaglia et al.	D7/656
D510,506	S	*	10/2005	Tranfaglia et al.	D7/656
D526,697	S	*	8/2006	Meroney	D22/132
D547,668	S	*	7/2007	Perez	D9/630
D560,431	S	*	1/2008	Sulier	D7/401.2
D562,897	S	*	2/2008	Ballinger	D19/59
D634,391	S	*	3/2011	Bernotsky et al.	D22/128
2013/0160298	A1	*	6/2013	Roberts	30/125

* cited by examiner

Primary Examiner — Ricky Pham

(74) *Attorney, Agent, or Firm* — Trenner Law Firm; Mark D. Trenner

(57) **CLAIM**

The ornamental design for a utensil accessory, as shown and described.

DESCRIPTION

FIG. 1 is a perspective view of the utensil accessory;
 FIG. 2 is another perspective view of the utensil accessory corresponding to FIG. 1 as the utensil accessory may be used with a utensil such as a spoon, wherein the spoon is exemplary of the use environment and does not form part of the design and therefore is shown in phantom;
 FIG. 3 is another perspective view of the utensil accessory corresponding to FIG. 1 as the utensil accessory may be used with a utensil such as a nail clipper, wherein the nail clipper is exemplary of the use environment and does not form part of the design and therefore is shown in phantom;
 FIG. 4 is a front view corresponding to FIG. 1;
 FIG. 5 is a rear view corresponding to FIG. 1;
 FIG. 6 is a right side view corresponding to FIG. 1, with the left side view being a mirror image thereof;
 FIG. 7 is a top plan view corresponding to FIG. 1; and,
 FIG. 8 is a bottom plan view corresponding to FIG. 1.

1 Claim, 6 Drawing Sheets

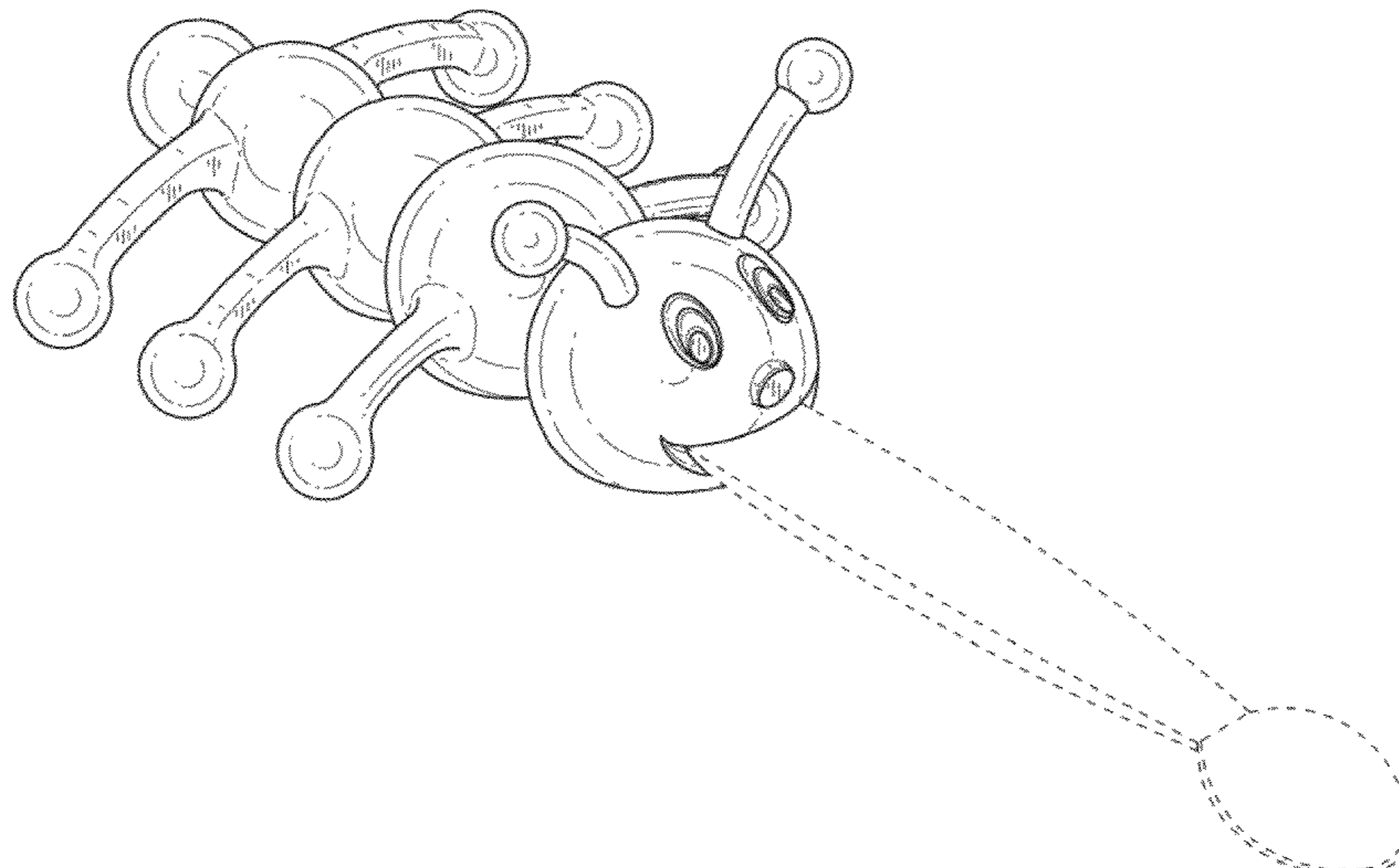
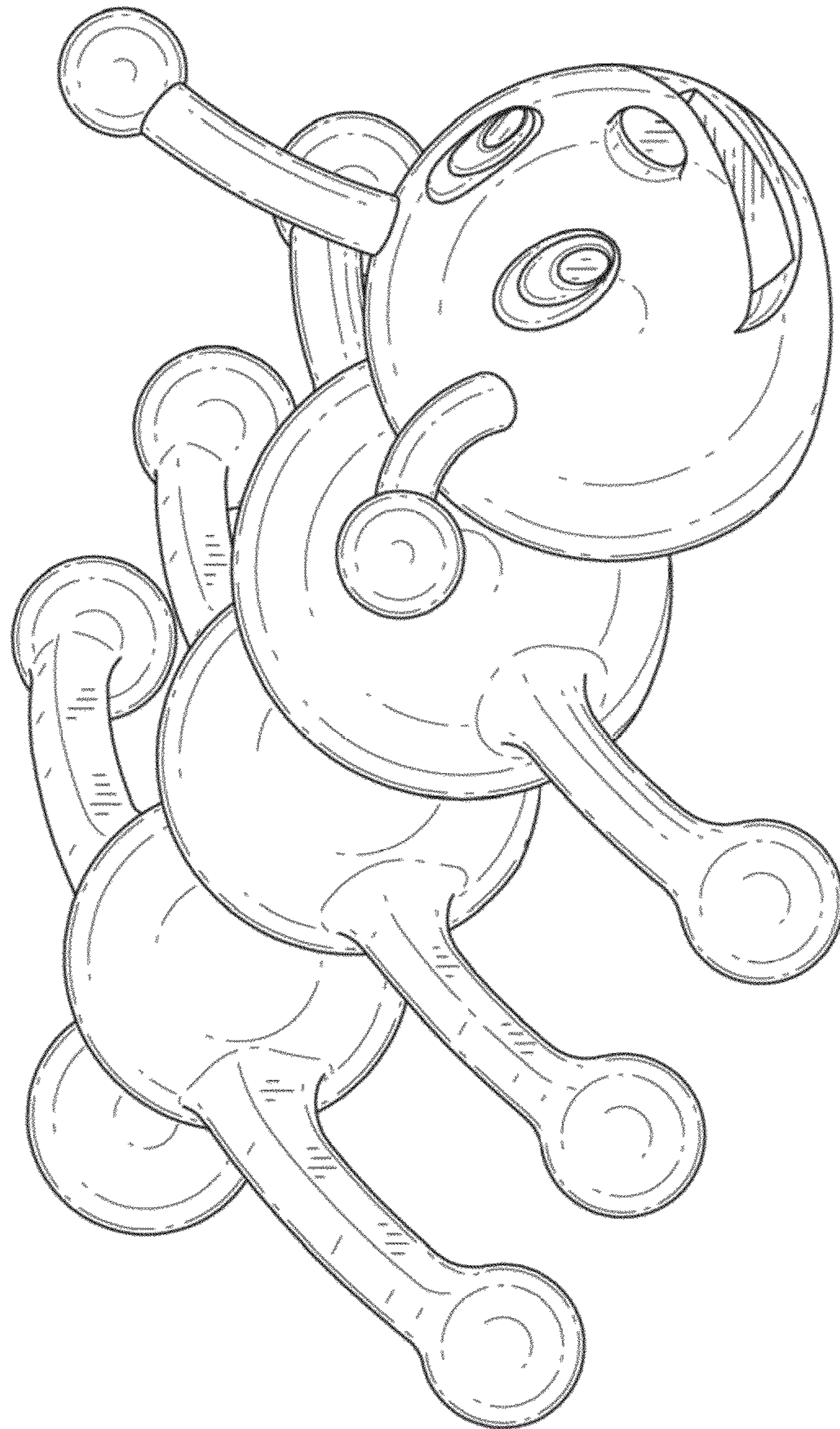

Fig. 1



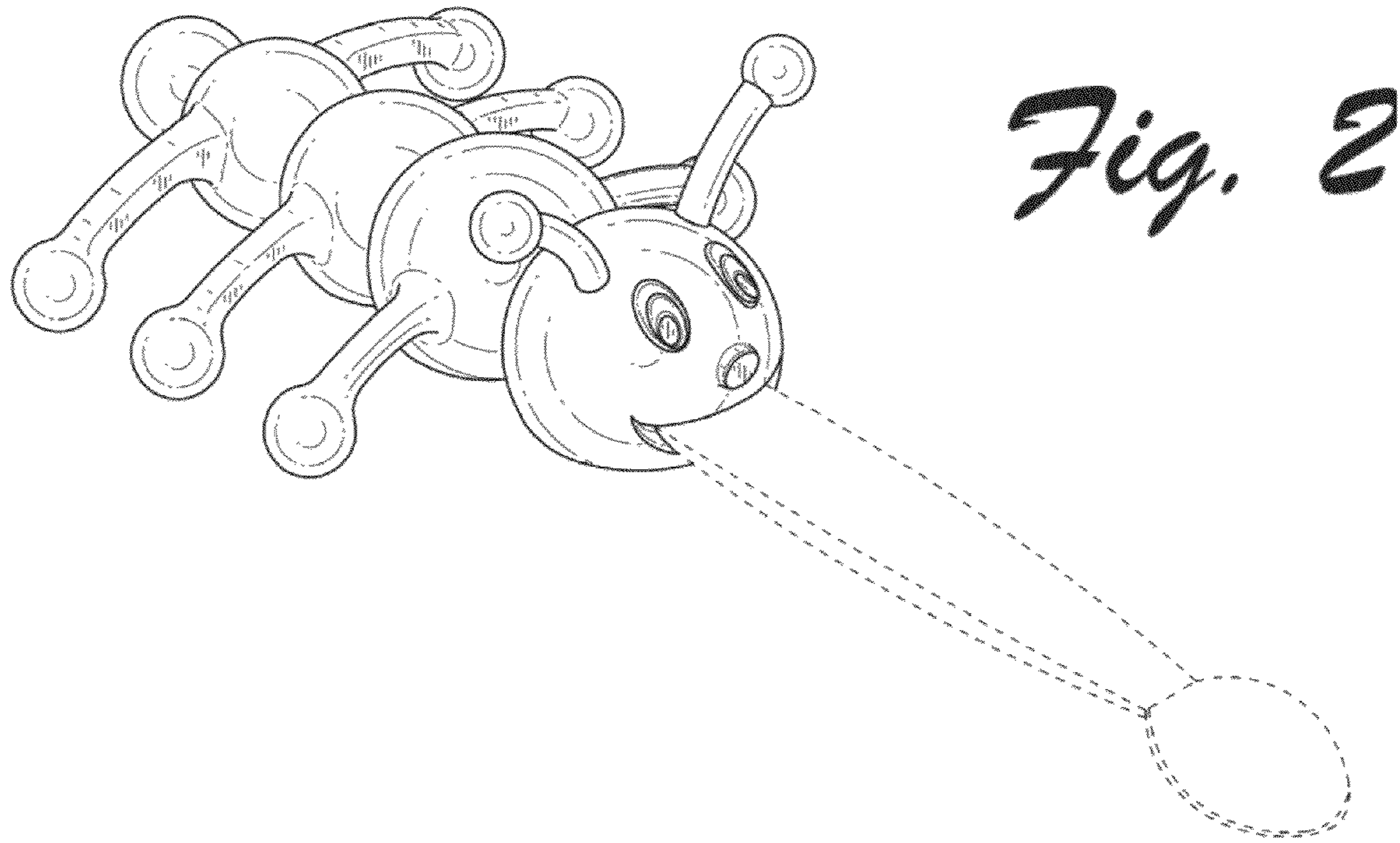

Fig. 3

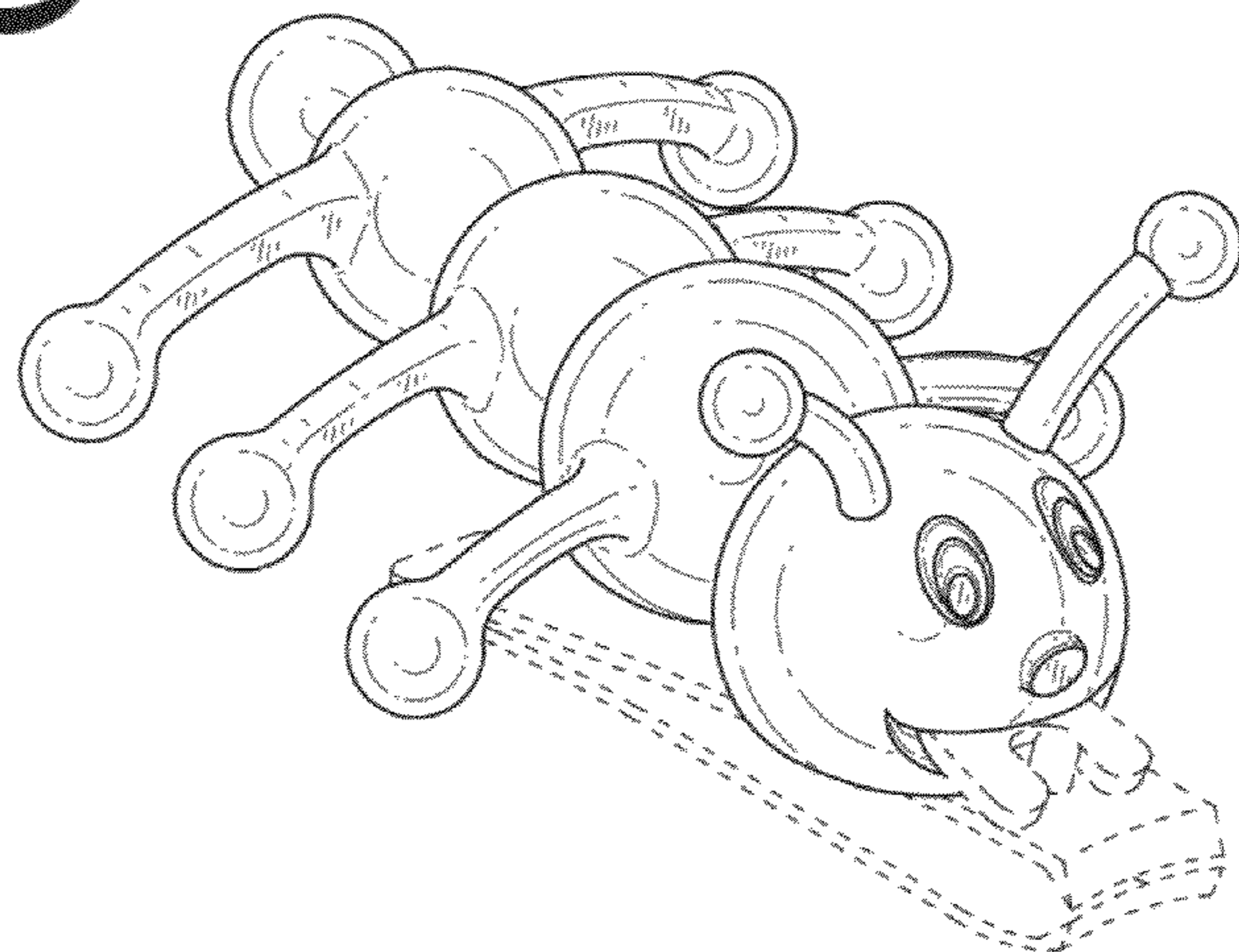

Fig. 4

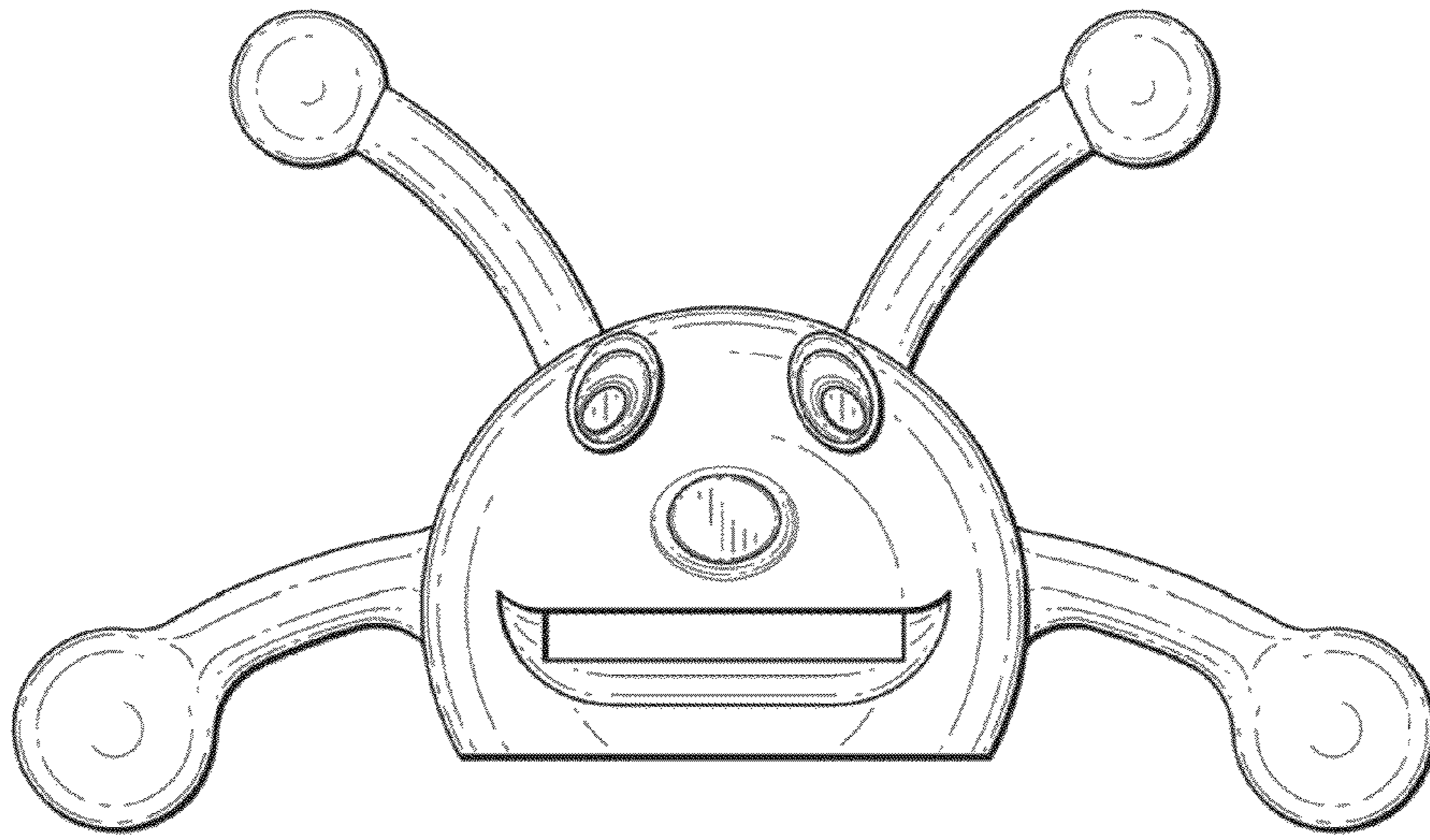

Fig. 5

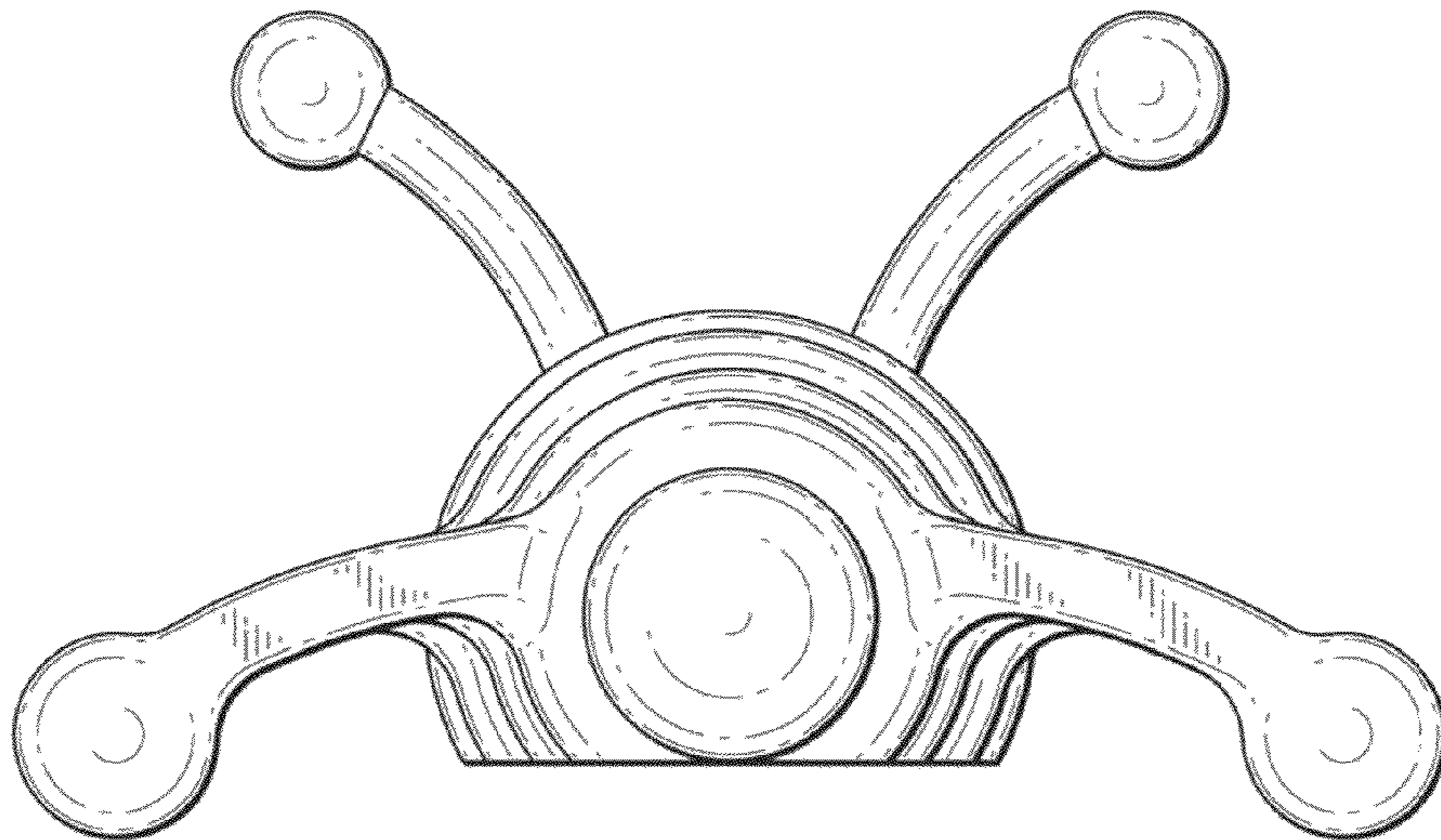

Fig. 6

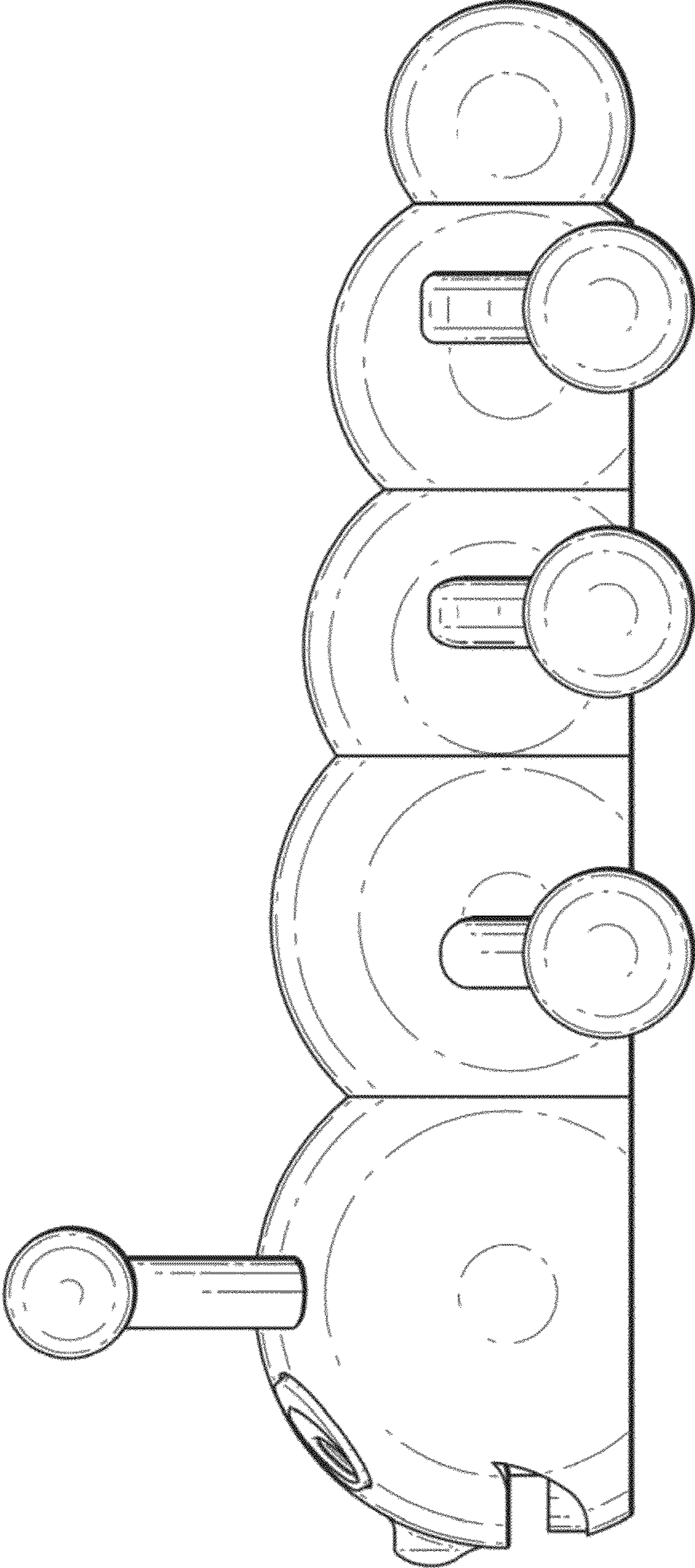

Fig. 7

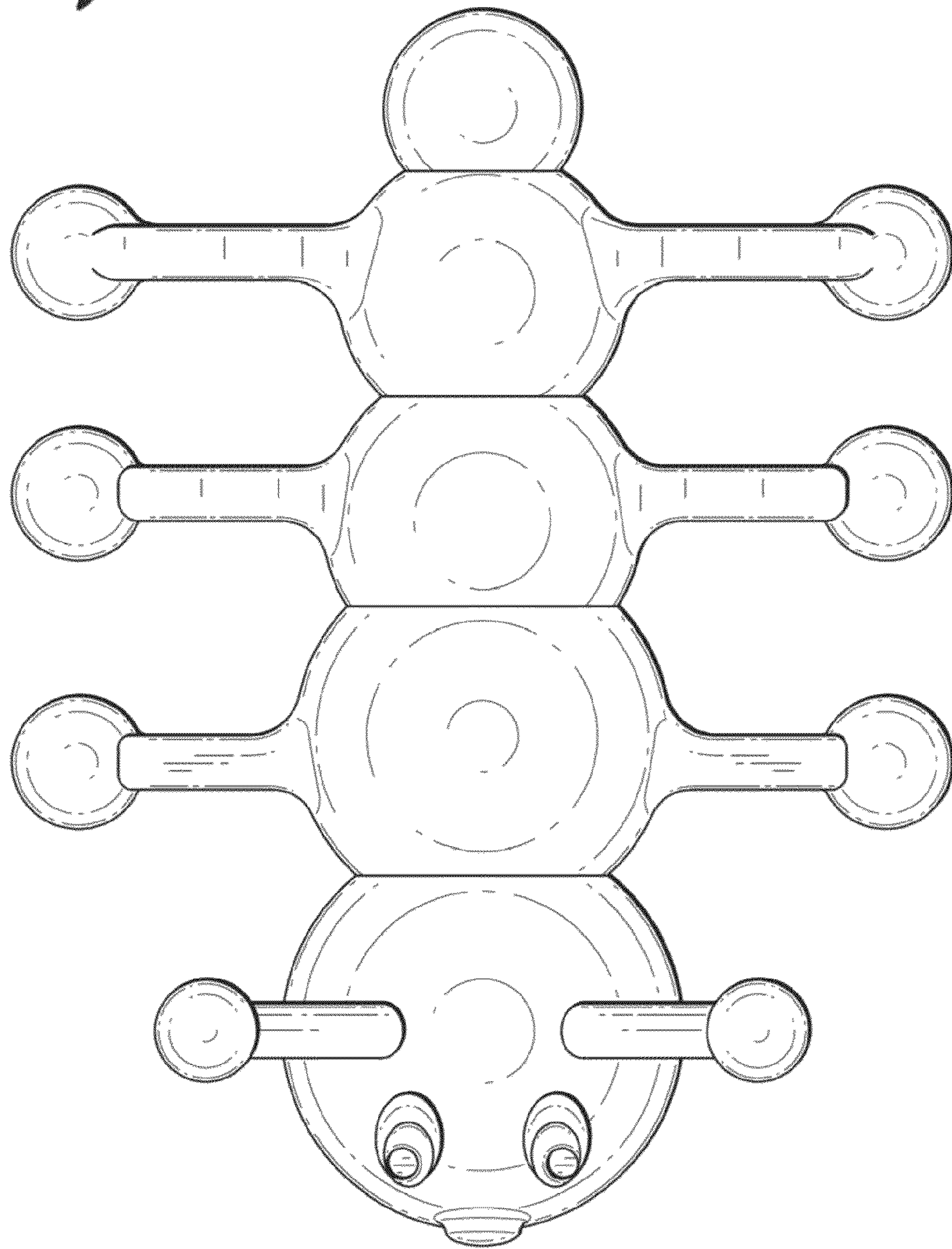

Fig. 8

