



US00D690896S

(12) **United States Design Patent**
Barber et al.

(10) **Patent No.:** **US D690,896 S**

(45) **Date of Patent:** **** Oct. 8, 2013**

(54) **SNACK FOOD PRODUCT**

(75) Inventors: **Keith Alan Barber**, Frisco, TX (US);
Deborah Fischer, McKinney, TX (US);
John Hildebrand, Flower Mound, TX
(US); **Enrique Michel**, Dallas, TX (US)

(73) Assignee: **Frito-Lay North America, Inc.**, Plano,
TX (US)

(**) Term: **14 Years**

(21) Appl. No.: **29/403,107**

(22) Filed: **Sep. 30, 2011**

Related U.S. Application Data

(63) Continuation-in-part of application No. 29/391,830,
filed on May 13, 2011.

(51) **LOC (9) Cl.** **01-01**

(52) **U.S. Cl.**
USPC **D1/125**

(58) **Field of Classification Search**
USPC D1/100-130, 199; D7/359, 409,
D7/388; 426/94, 144, 104, 138, 391, 549,
426/808, 143, 559, 560; D25/138; D9/456;
428/182; 521/79; 72/301; 119/710
See application file for complete search history.

(56) **References Cited**

U.S. PATENT DOCUMENTS

95,900 A * 10/1869 Crowley 428/182
2,769,714 A 11/1956 Stahmer

(Continued)

FOREIGN PATENT DOCUMENTS

DE 40203260-0001.1 5/2003
EM 001102180-0007 4/2009

(Continued)

OTHER PUBLICATIONS

Lay's Wavy Original, photograph of bag and close-up of individual
chips.

(Continued)

Primary Examiner — Deanna L. Pratt

Assistant Examiner — Katie Mroczka

(74) *Attorney, Agent, or Firm* — Colin P. Cahoon; Celina M.
Orr; Carstens & Cahoon, LLP

(57) **CLAIM**

The ornamental design for a snack food product, as shown
and described.

DESCRIPTION

FIG. 1 is a perspective view of the first embodiment of a snack
food product, showing our new design;
FIG. 2 is a top elevation view thereof;
FIG. 3 is a left elevation view thereof;
FIG. 4 is a right elevation view thereof;
FIG. 5 is a front elevation view thereof;
FIG. 6 is a rear elevation view thereof;
FIG. 7 is a bottom elevation view thereof;
FIG. 8 is a perspective view of the second embodiment of a
snack food product showing our new design;
FIG. 9 is a top elevation view thereof;
FIG. 10 is a left elevation view thereof;
FIG. 11 is a right elevation view thereof;
FIG. 12 is a front elevation view thereof;
FIG. 13 is a rear elevation view thereof;
FIG. 14 is a bottom elevation view thereof;
FIG. 15 is a perspective view of the third embodiment of a
snack food product showing our new design;
FIG. 16 is a top elevation view thereof;
FIG. 17 is a left elevation view thereof;
FIG. 18 is a right elevation view thereof;
FIG. 19 is a front elevation view thereof;
FIG. 20 is a rear elevation view thereof; and,
FIG. 21 is a bottom elevation view thereof.

1 Claim, 9 Drawing Sheets

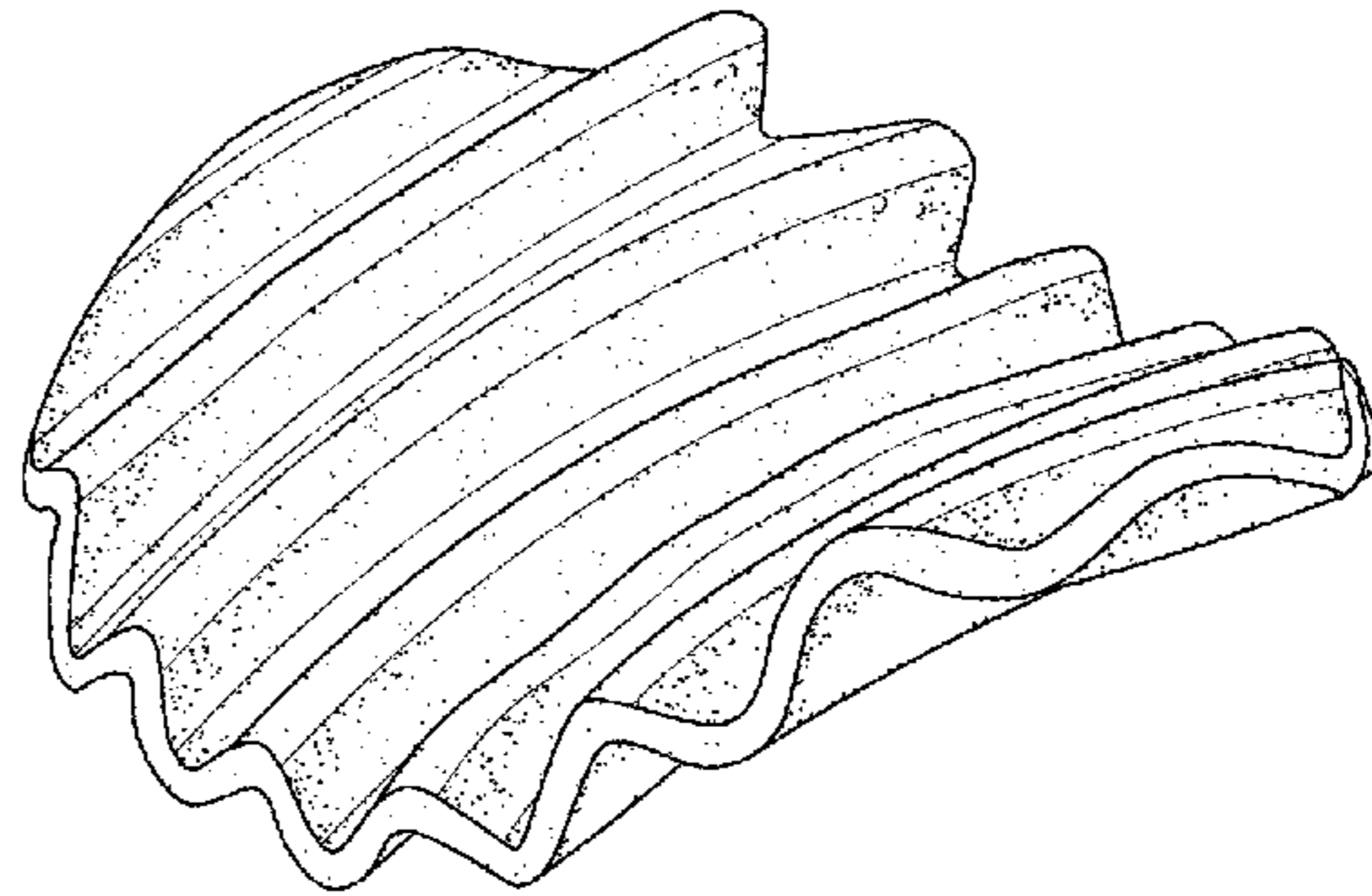
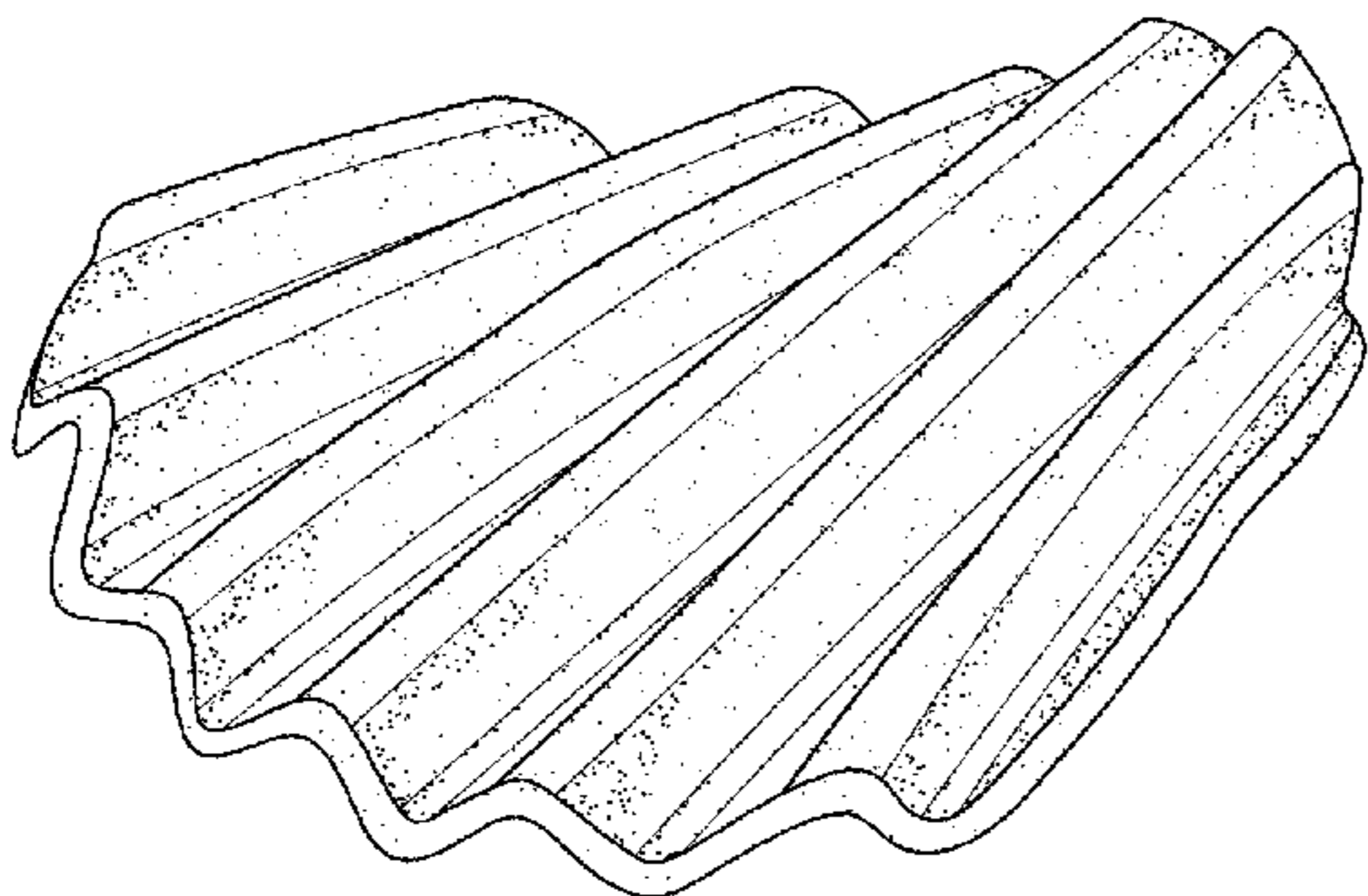

(56)

References Cited

U.S. PATENT DOCUMENTS

2,769,715 A * 11/1956 Stahmer 426/144
 3,139,127 A 6/1964 Urschel et al.
 3,139,130 A 6/1964 Urschel et al.
 3,498,798 A 3/1970 Baur et al.
 D219,637 S 1/1971 Holtz, Jr. et al.
 D228,827 S 10/1973 Cammelot et al.
 3,956,517 A 5/1976 Curry et al.
 4,508,739 A 4/1985 Ryan
 4,515,817 A * 5/1985 Pavan 426/106
 4,601,227 A 7/1986 Fitzwater et al.
 4,650,684 A 3/1987 Penrose
 4,680,191 A 7/1987 Budd et al.
 4,852,441 A 8/1989 Anders et al.
 4,855,151 A 8/1989 Fielding
 4,889,737 A 12/1989 Willard et al.
 4,933,194 A 6/1990 Barry et al.
 4,973,481 A 11/1990 Hunt et al.
 5,128,157 A * 7/1992 Ruiz 426/106
 5,419,903 A * 5/1995 Evans et al. 426/144
 D380,885 S 7/1997 Goll
 D389,373 S * 1/1998 Belue D7/354
 6,117,466 A 9/2000 Moriki et al.
 6,403,135 B1 6/2002 Graham et al.
 D495,852 S 9/2004 Barber
 D540,507 S * 4/2007 Aleman et al. D1/125
 D541,006 S * 4/2007 Baumgartner D1/121

7,331,087 B2 * 2/2008 Lindsay et al. 24/442
 D577,176 S 9/2008 Young et al.
 D625,486 S * 10/2010 Bhaskar et al. D1/123
 D640,036 S 6/2011 Walker et al.
 D643,178 S * 8/2011 Howe et al. D1/125
 D670,560 S * 11/2012 Amend D9/456
 D670,561 S * 11/2012 Amend D9/456

FOREIGN PATENT DOCUMENTS

EP 0387606 A2 9/1990
 ES IO122893 11/1990
 ES 128967 12/1992
 GB 2172185 A 9/1986
 GB 3022357 10/2005
 HU D0200424 12/2002
 HU D0300061 2/2003
 KR 3001490080000 2/1994
 KR 300472482 12/2007
 RU 71061 7/2009

OTHER PUBLICATIONS

Ruffles Brand, Ruffles Have Ridges, Original Potato Chips, photograph of bag and close-up of individual chips.
 Russian Magazine "Vitrina", No. 5, Jun. 2003, p. 26.
 Catalogue of "Frazer", Finland, 1991.
 Russian Magazine "Rosyiskyi Prodovolstvennyi Rynok/Food & Drinks", No. 11(75), 2005, p. 15.

* cited by examiner

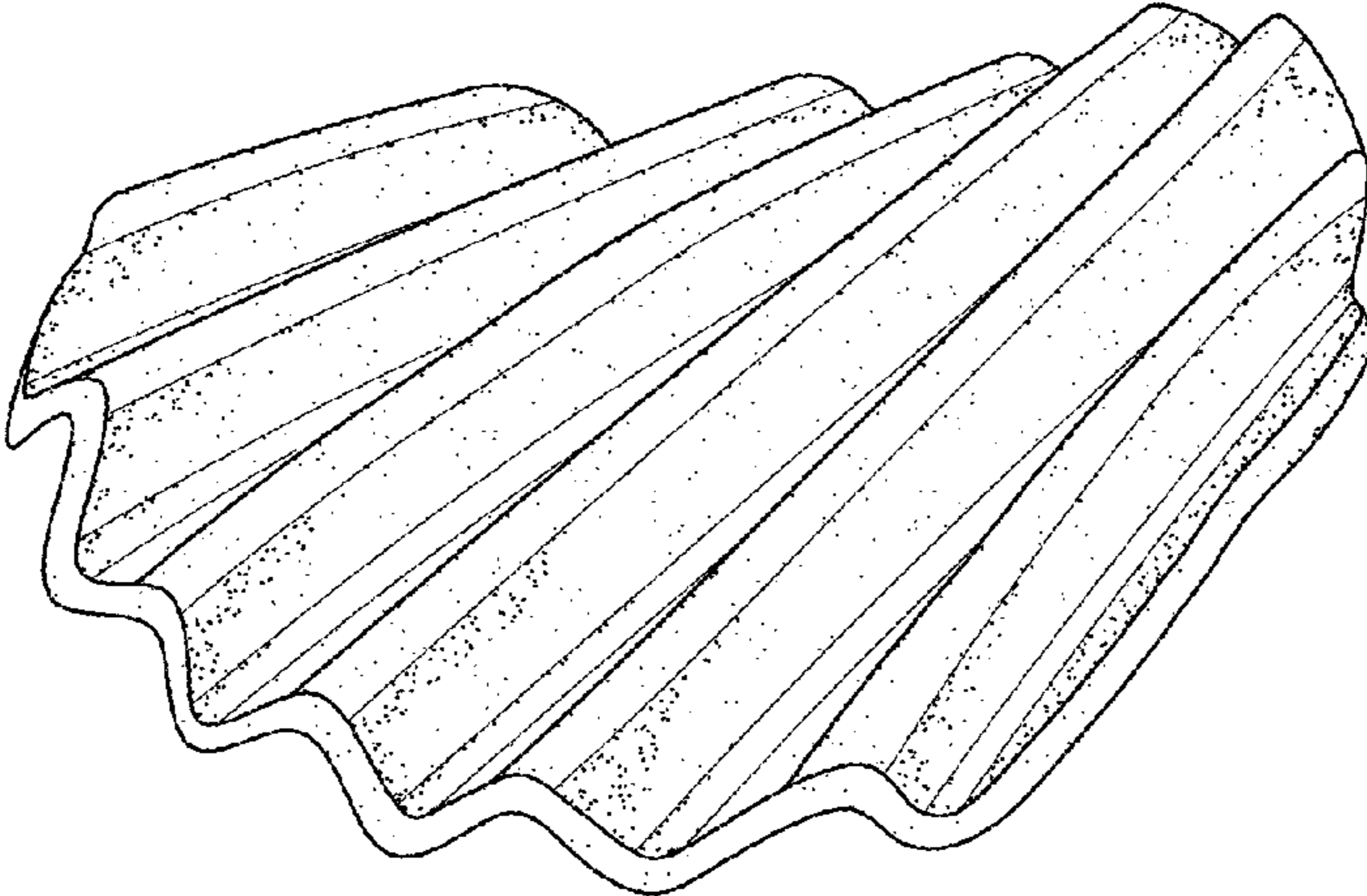

FIG. 1

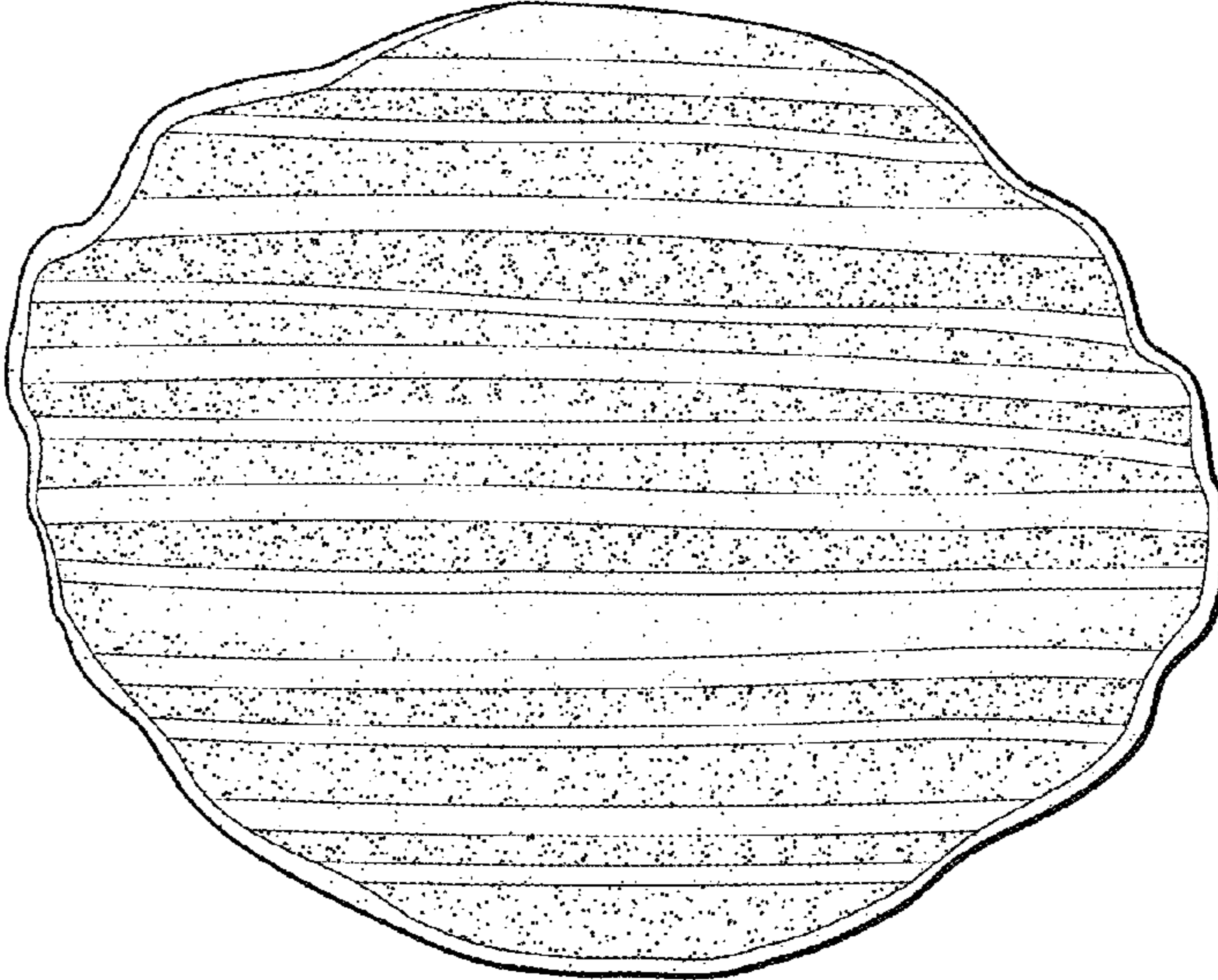

FIG. 2

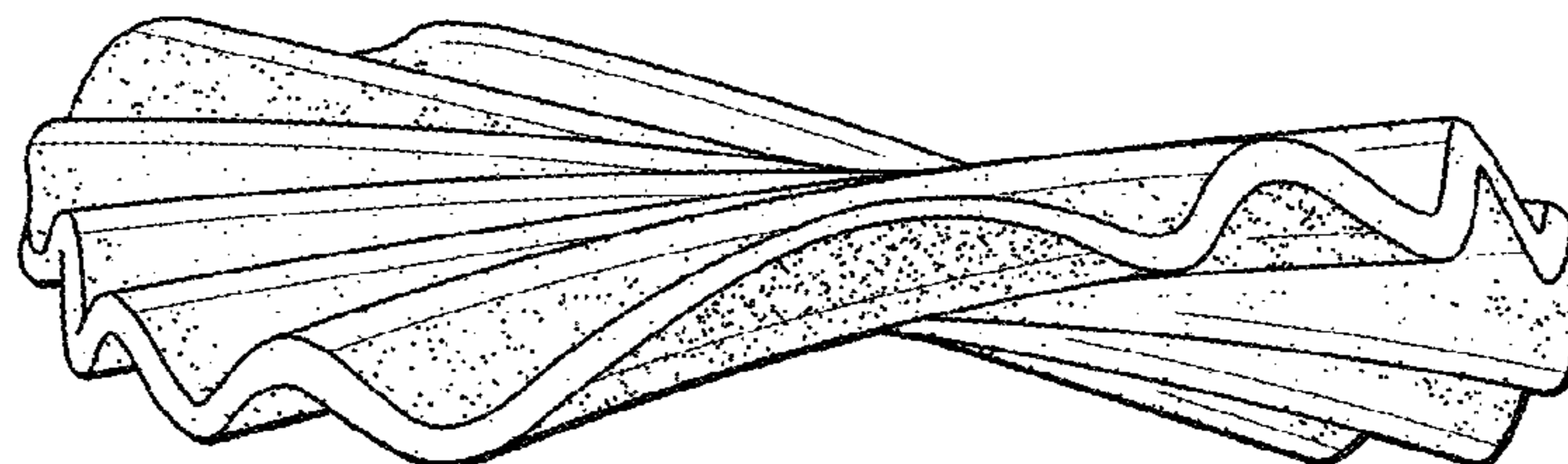

FIG. 3

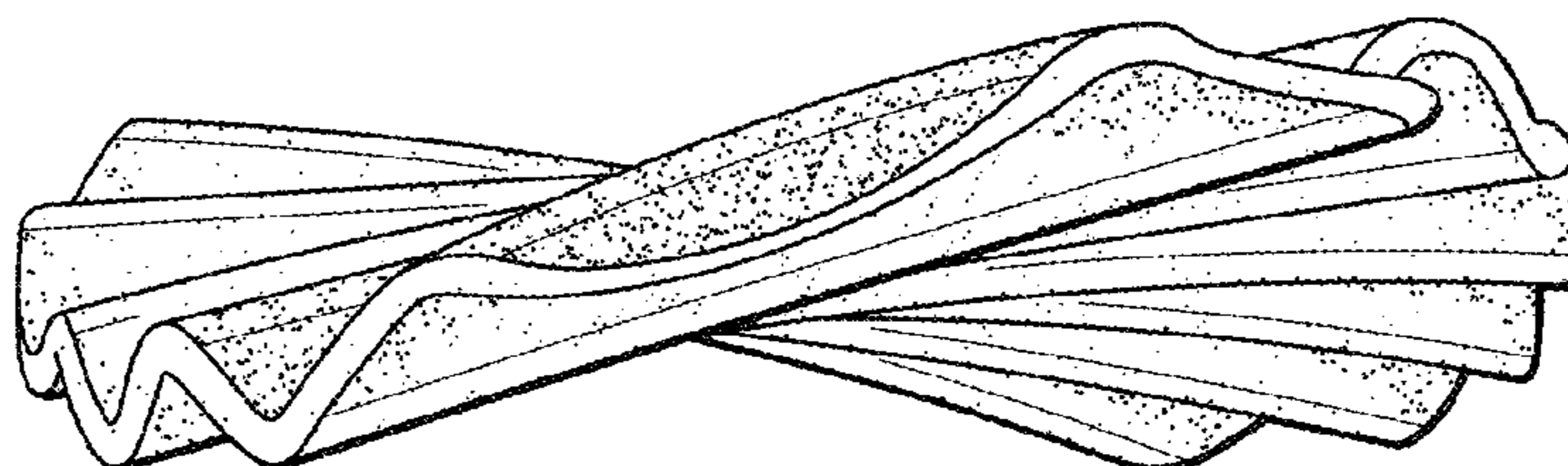

FIG. 4

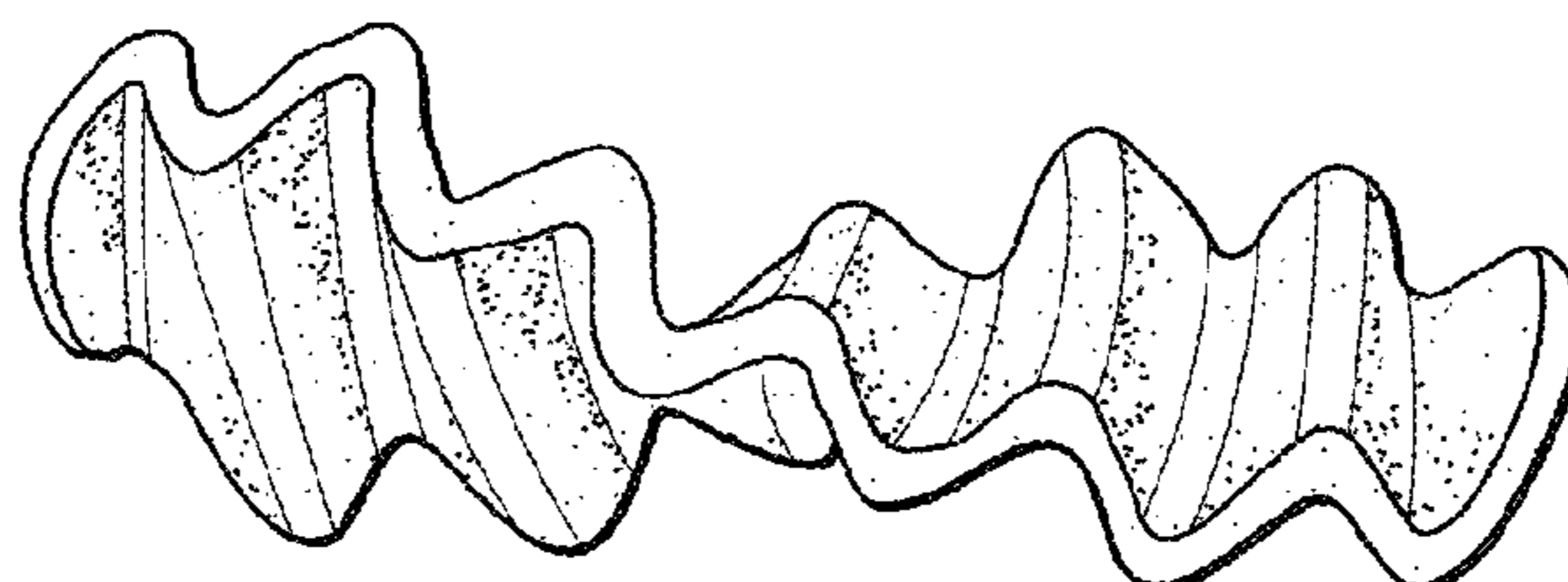

FIG. 5

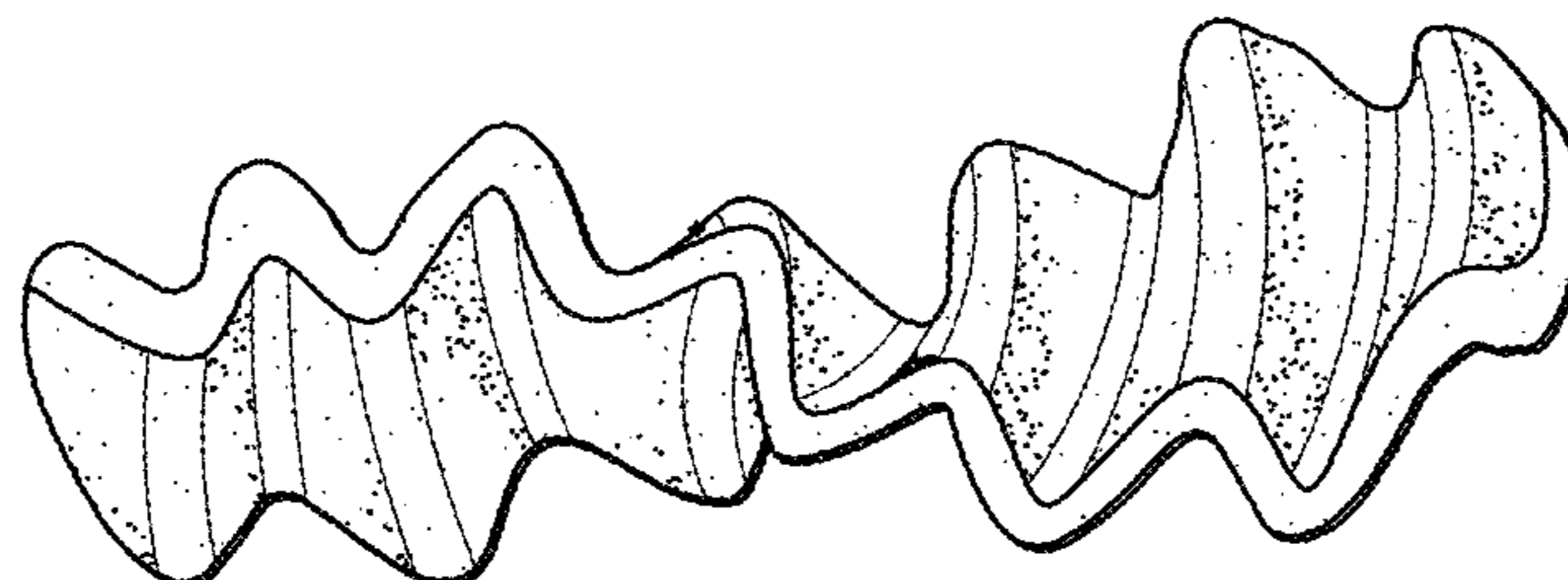

FIG. 6

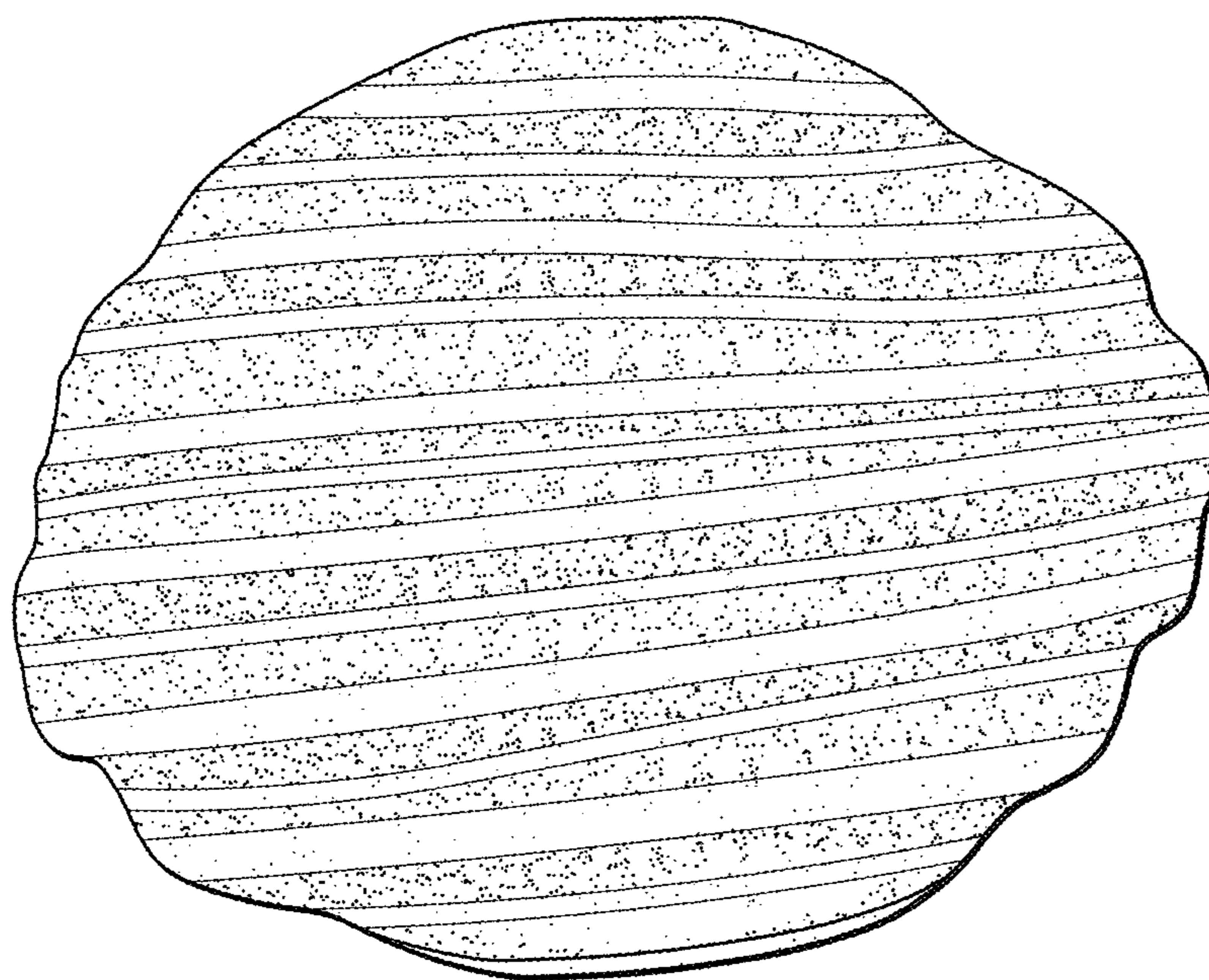

FIG. 7

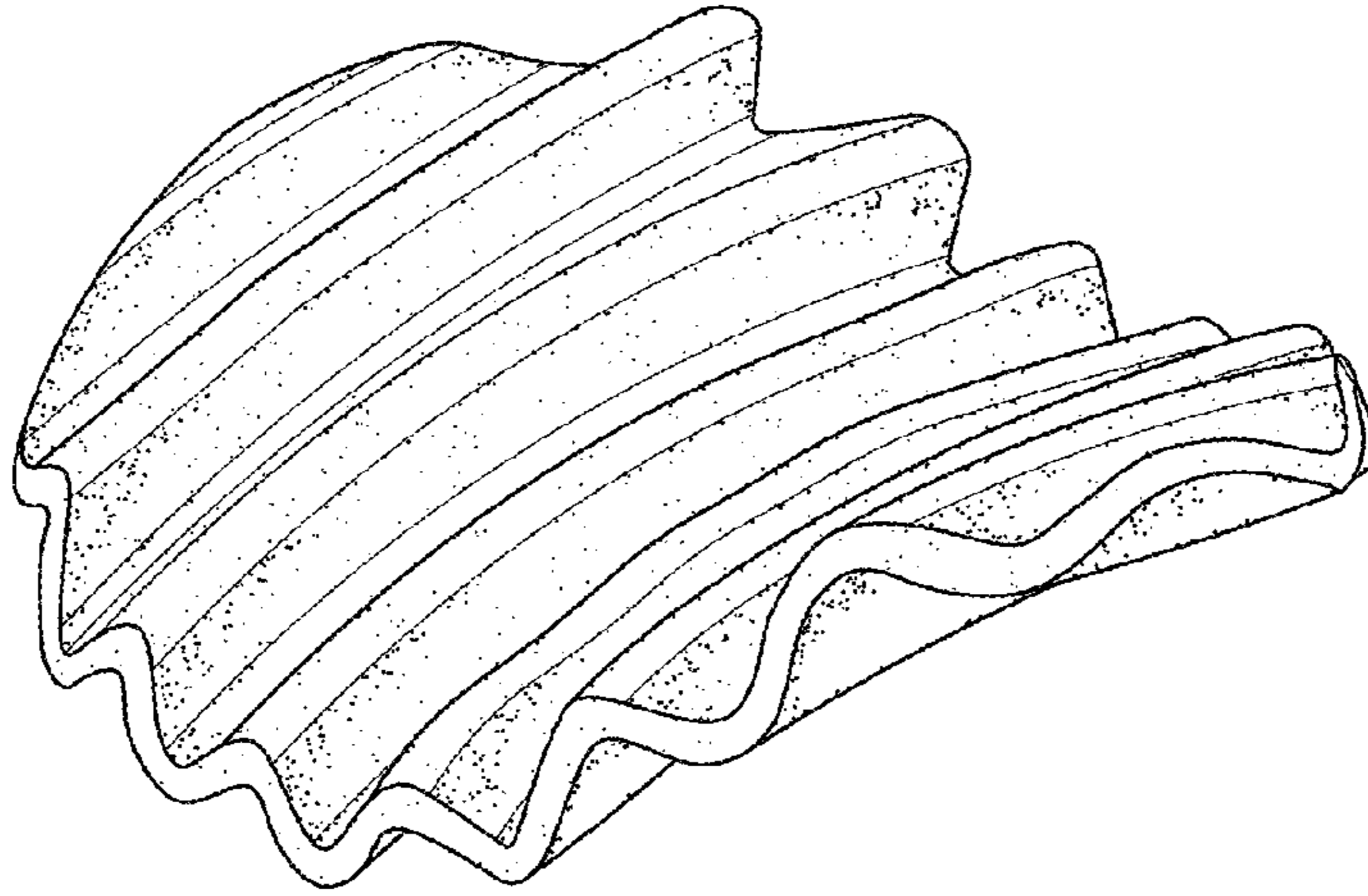

FIG. 8

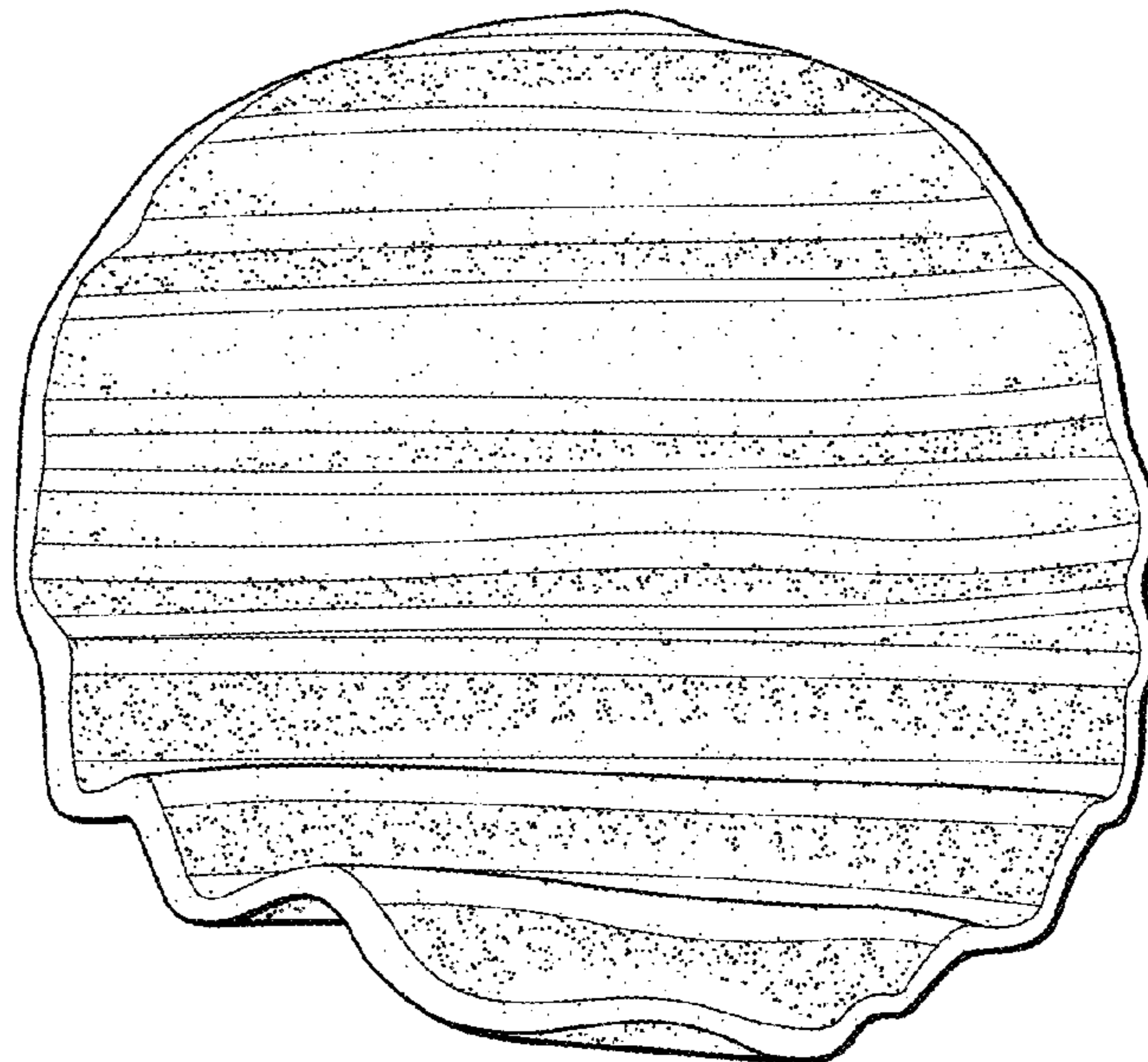

FIG. 9

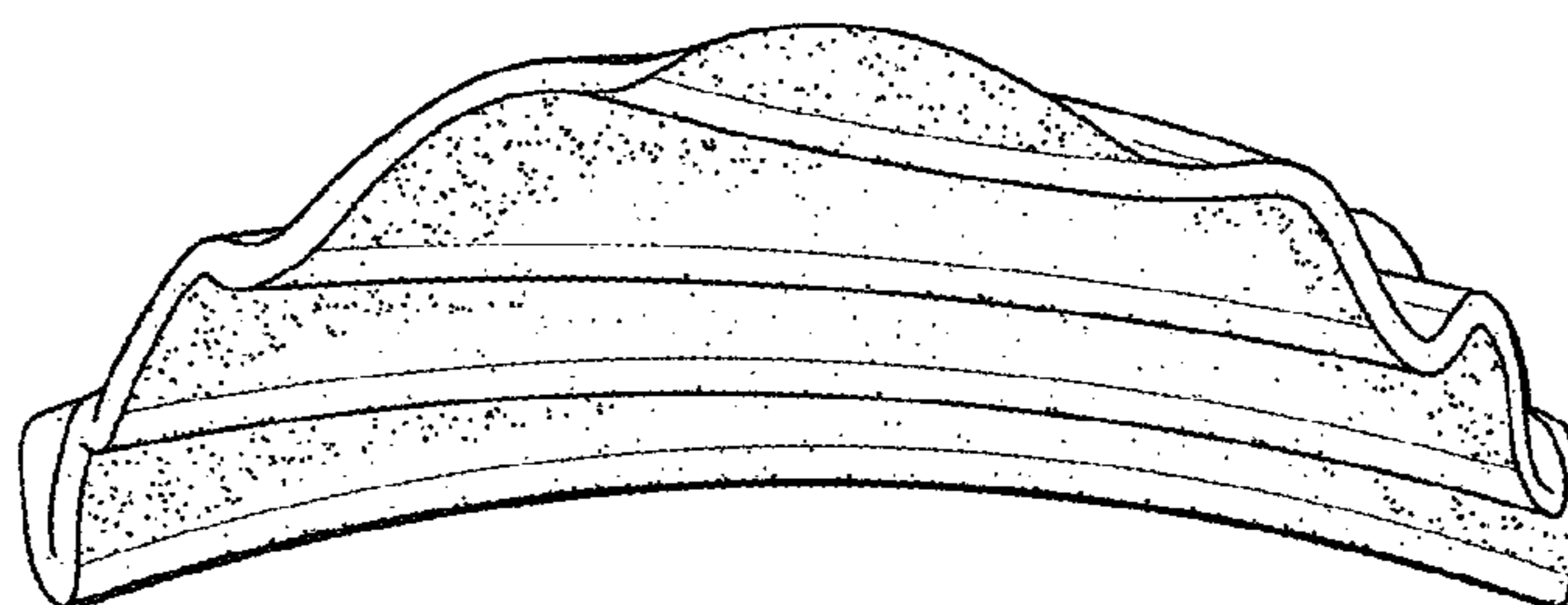

FIG. 10

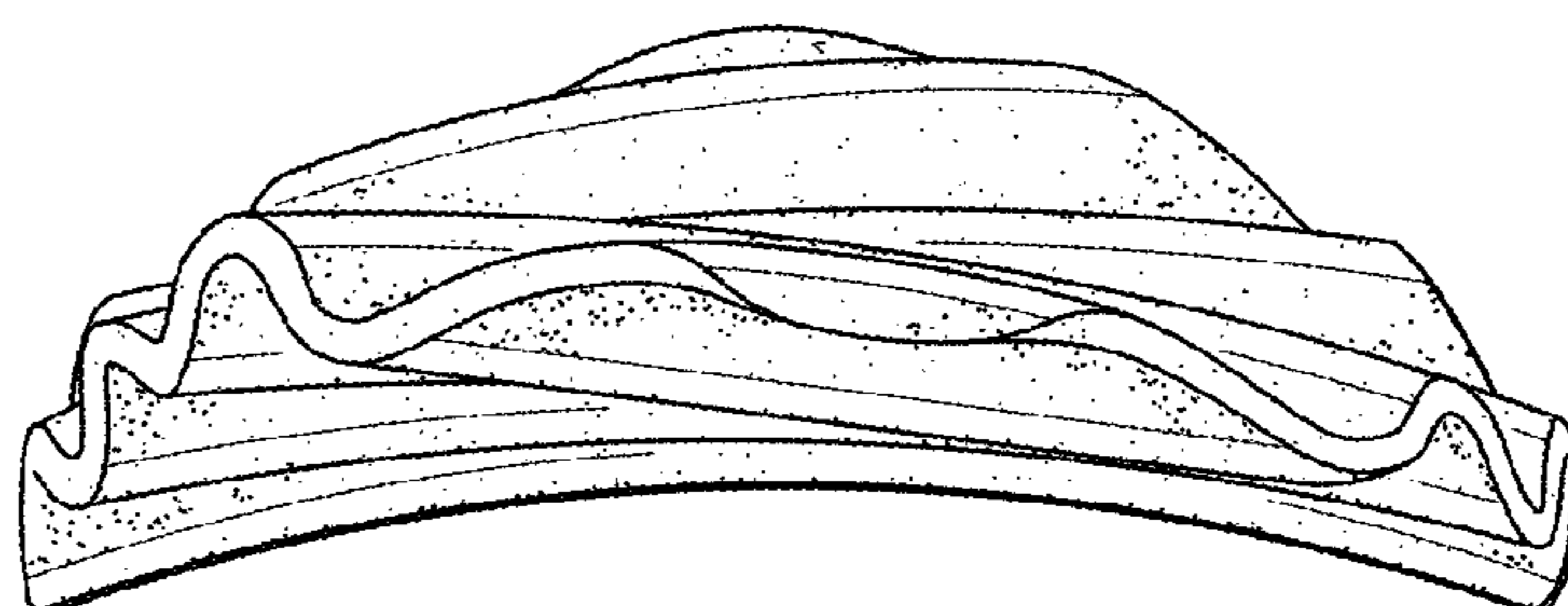

FIG. 11

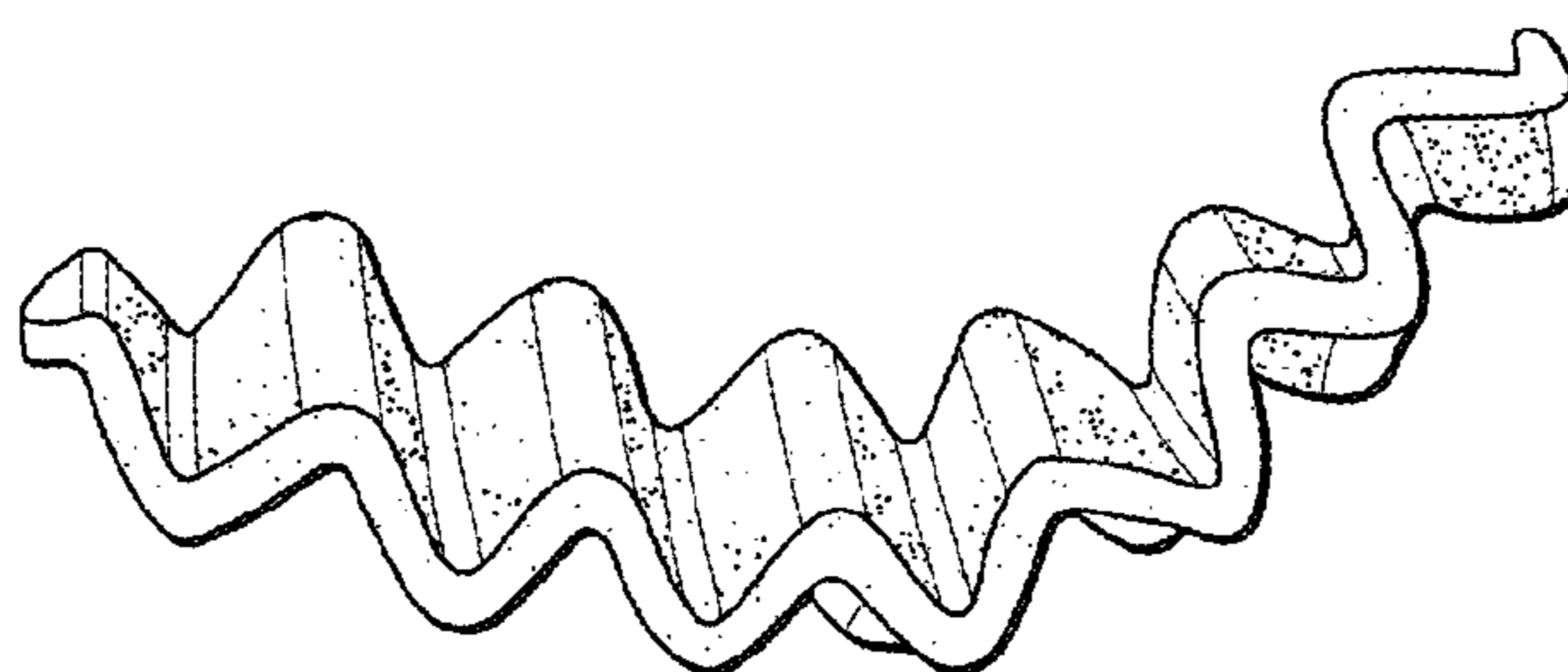

FIG. 12

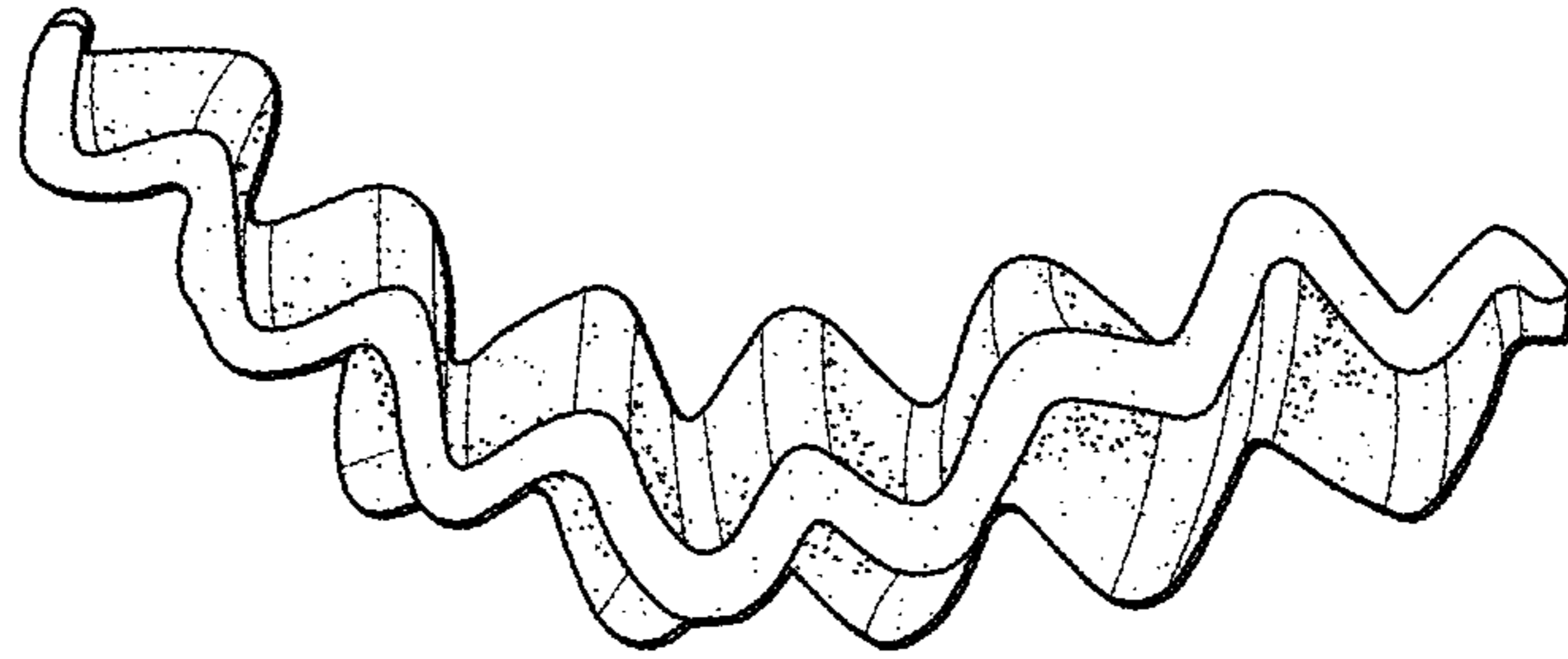

FIG. 13

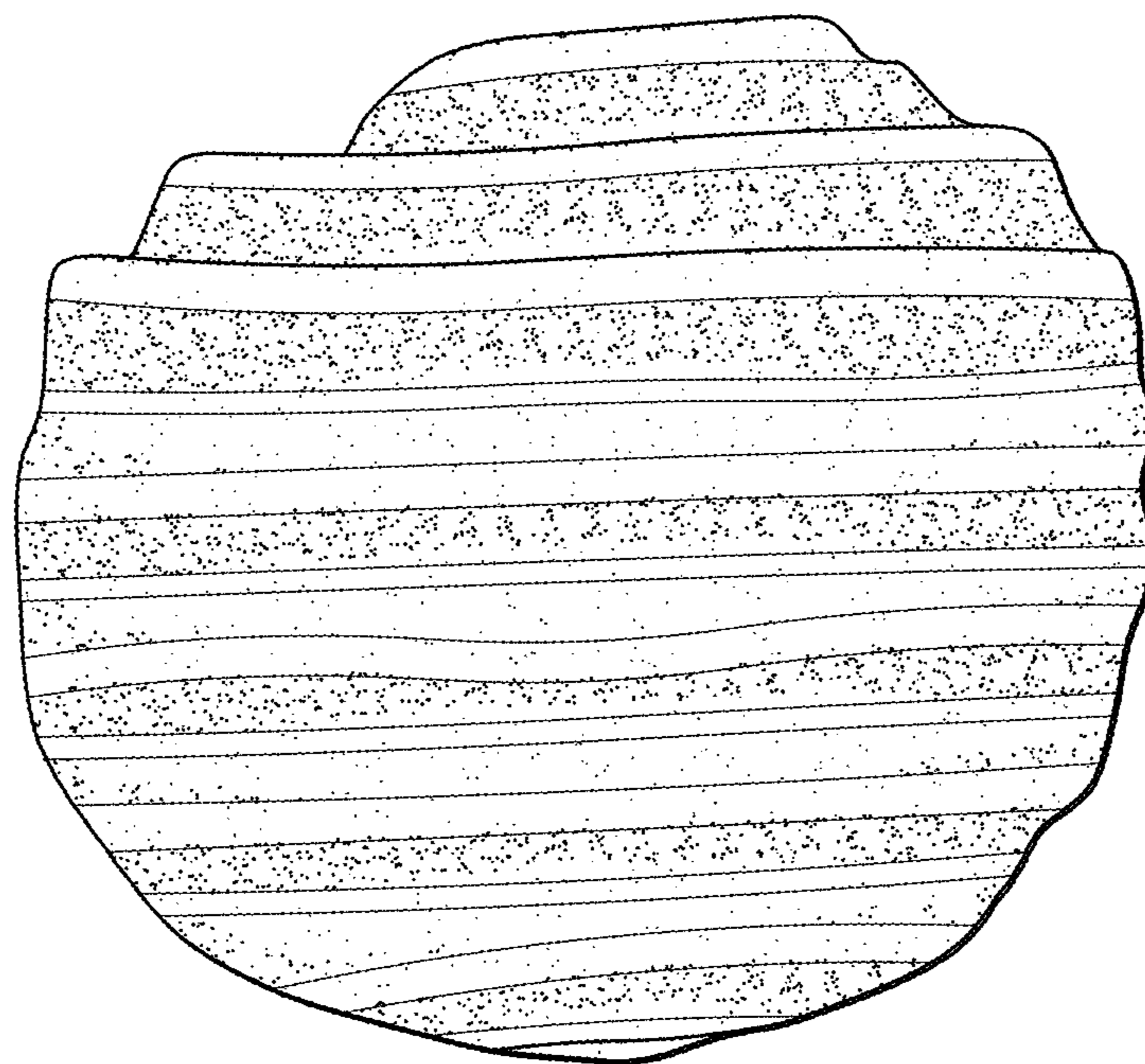

FIG. 14

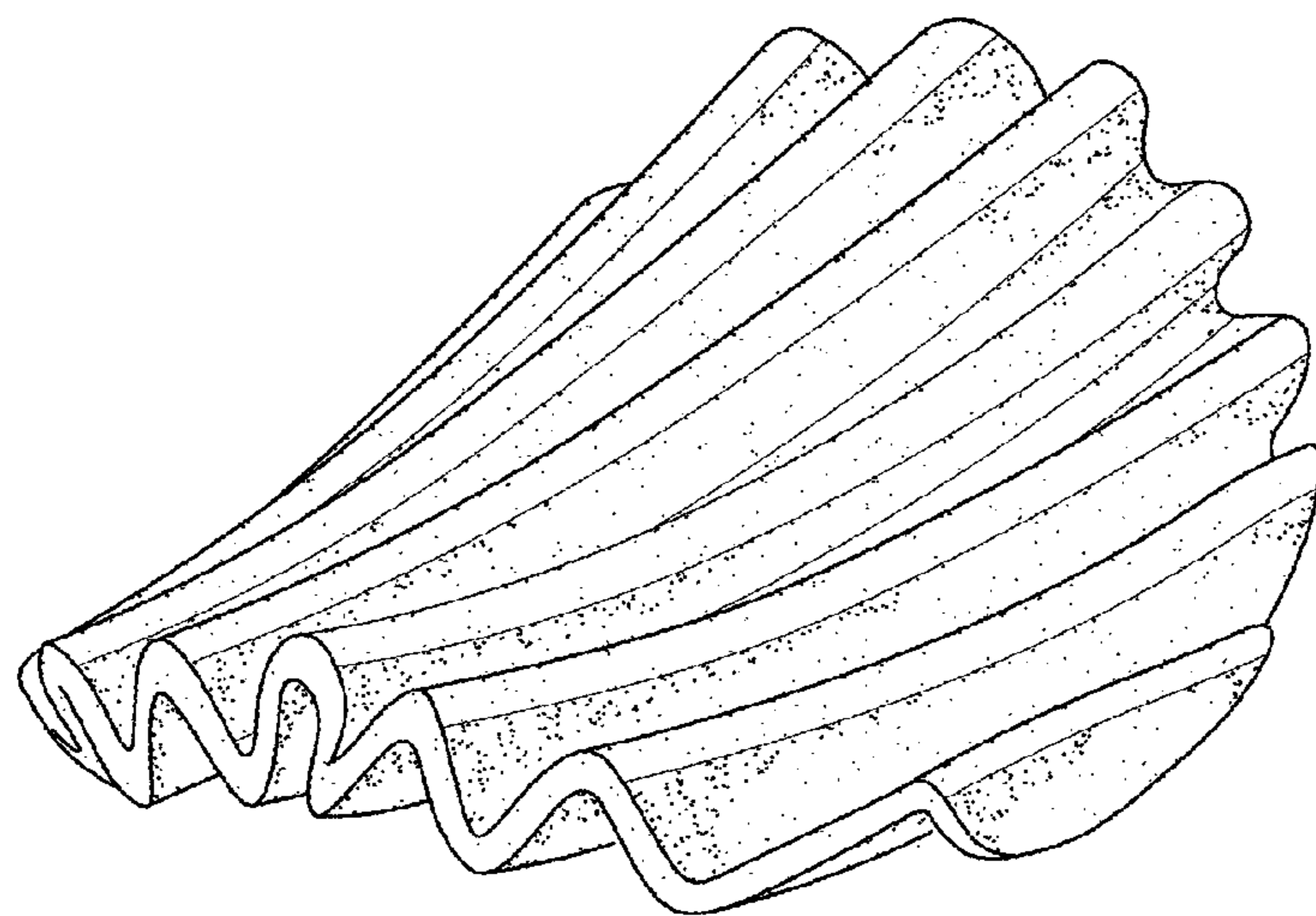

FIG. 15



FIG. 16

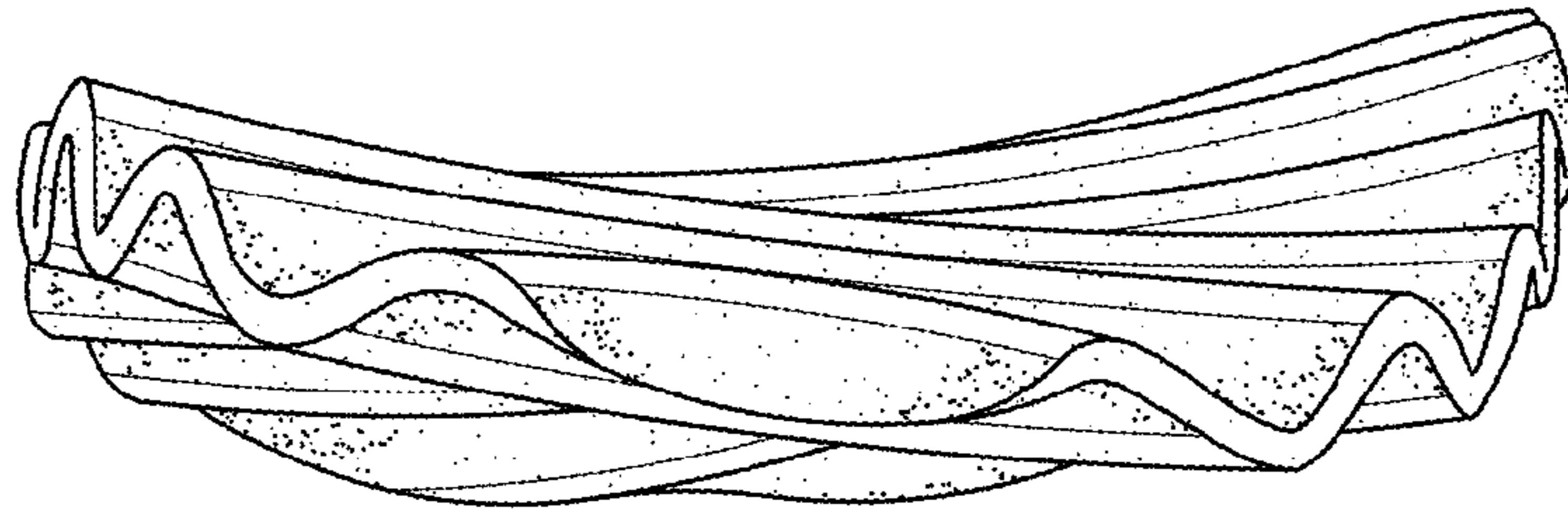

FIG. 17

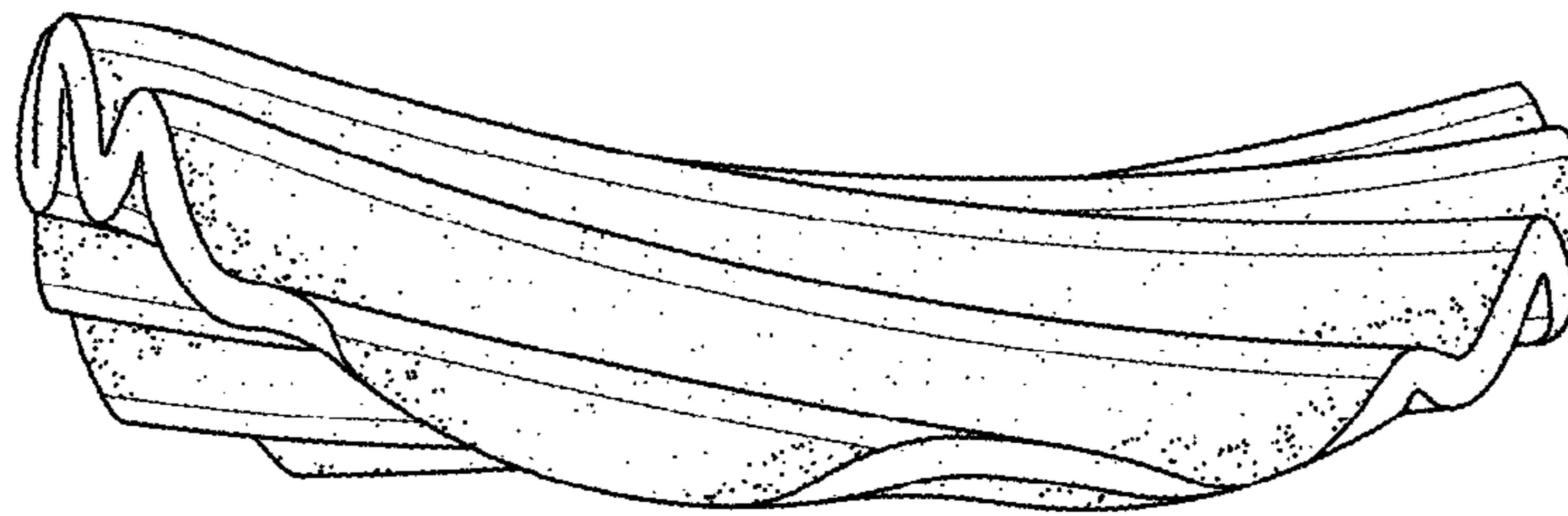

FIG. 18

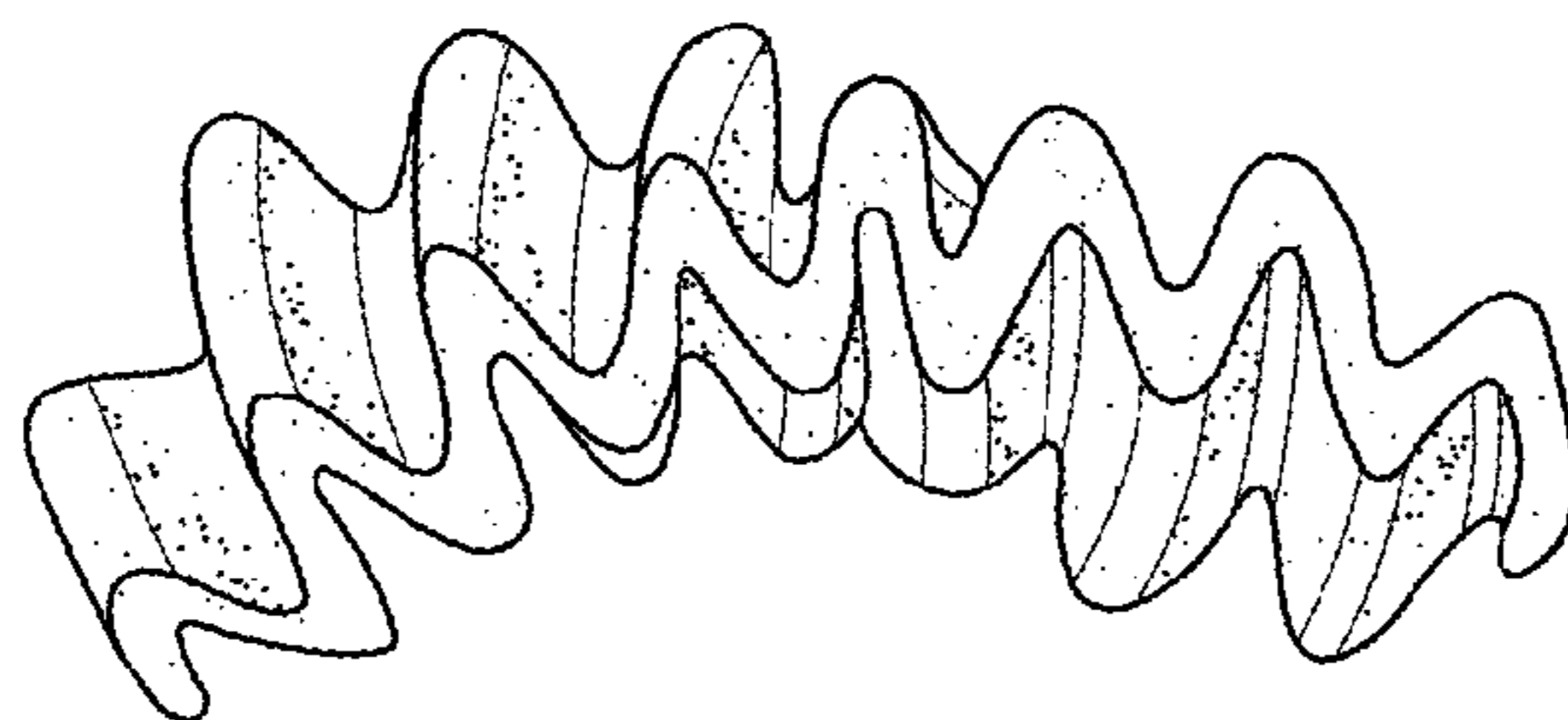

FIG. 19

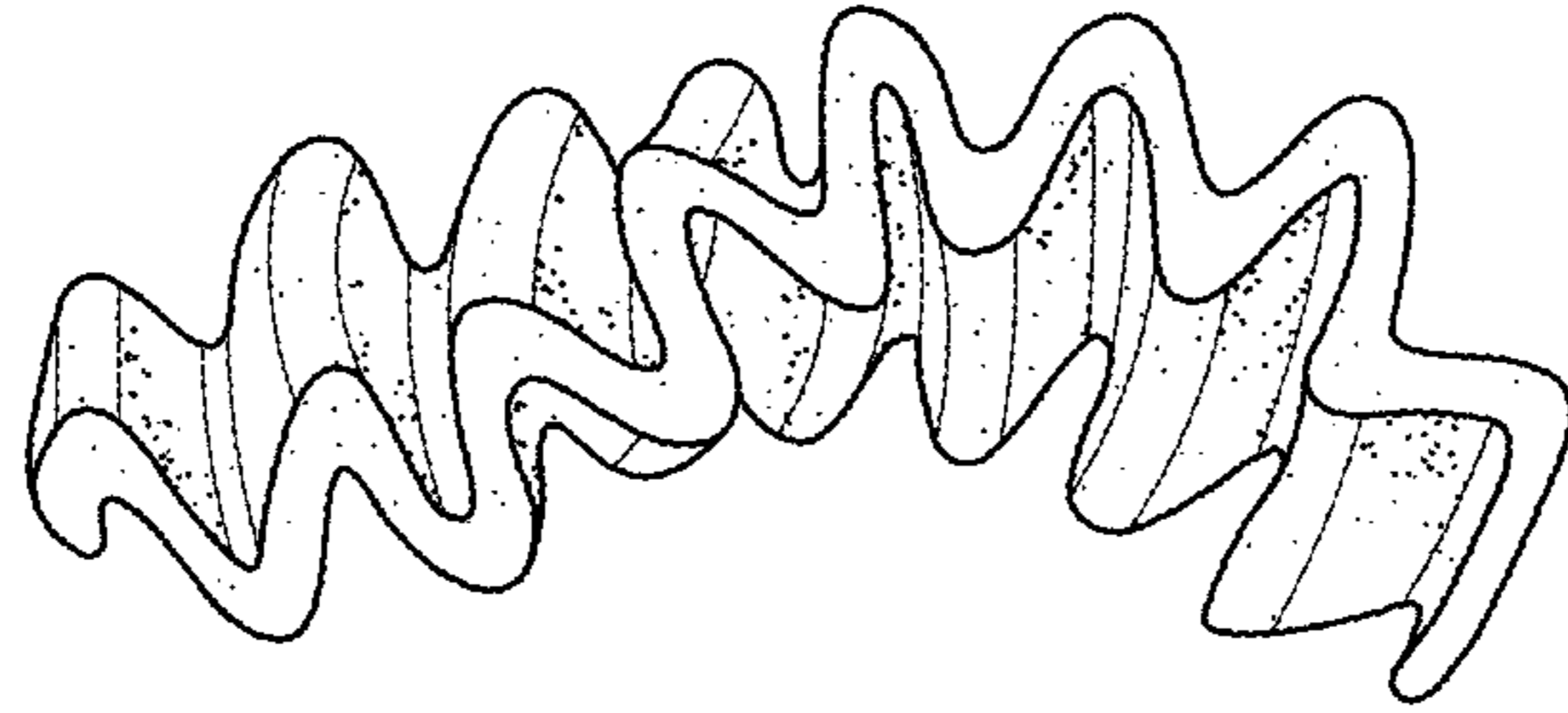

FIG. 20

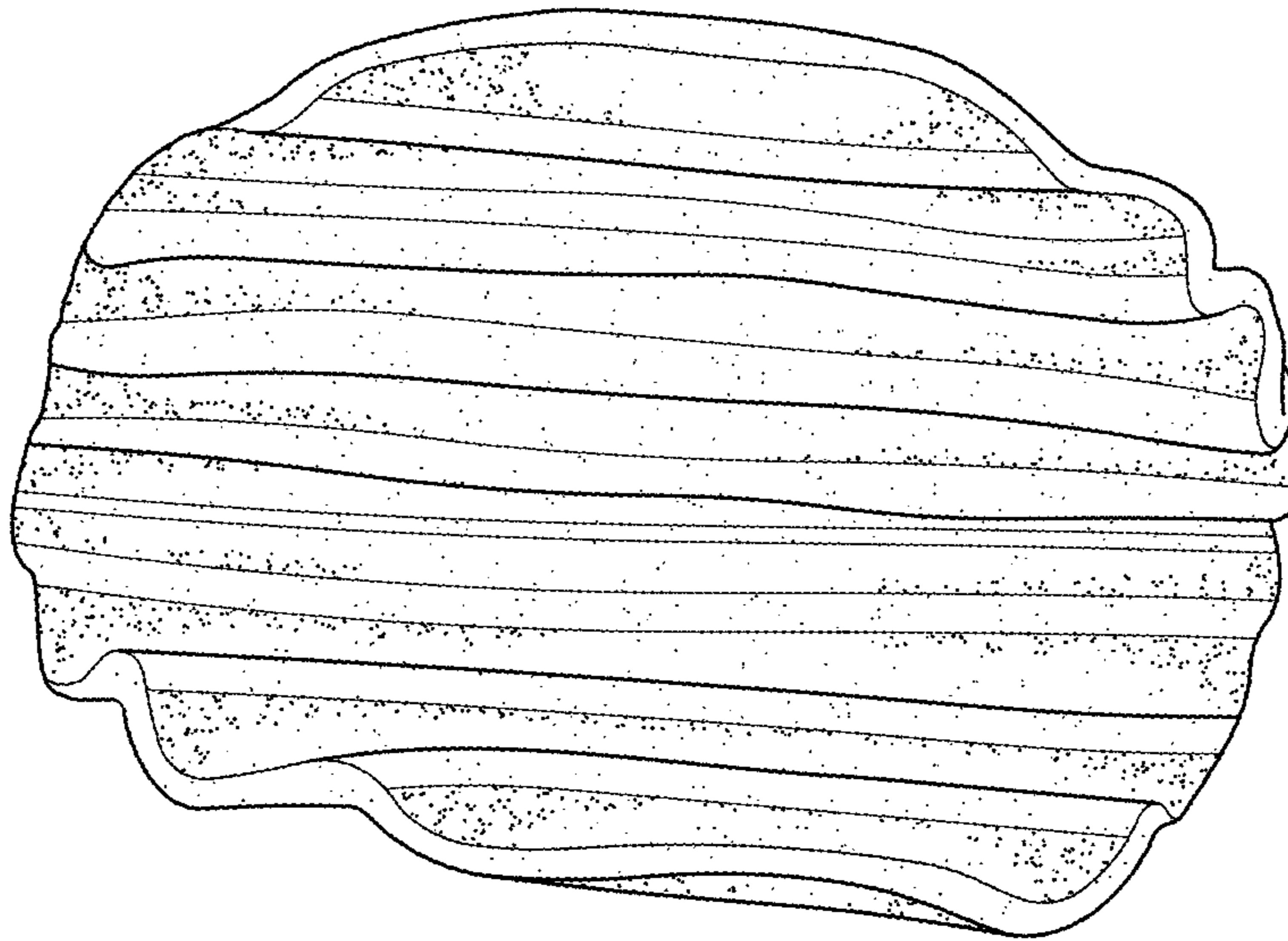

FIG. 21