



US00D690745S

(12) **United States Design Patent**
Koide et al.

(10) **Patent No.:** **US D690,745 S**

(45) **Date of Patent:** **** Oct. 1, 2013**

(54) **LASER PROCESSING MACHINE**
(71) Applicants: **Komatsu NTC Ltd.**, Nanto (JP);
Komatsu Ltd, Tokyo (JP)

(72) Inventors: **Toshihiro Koide**, Tokyo (JP); **Seiichi Hayashi**, Nanto (JP); **Koji Masauji**, Nanto (JP)

(73) Assignees: **Komatsu Industries Corporation**, Kanazawa-Shi (JP); **Komatsu Ltd.**, Tokyo (JP)

(**) Term: **14 Years**

(21) Appl. No.: **29/450,778**

(22) Filed: **Mar. 22, 2013**

(30) **Foreign Application Priority Data**

Oct. 26, 2012 (JP) 2012-026156

(51) **LOC (9) Cl.** **15-09**

(52) **U.S. Cl.**
USPC **D15/122**

(58) **Field of Classification Search**
USPC D15/122, 127, 199; 219/121.6–121.86;
372/9, 19, 29, 92, 99, 107–109
See application file for complete search history.

(56) **References Cited**

U.S. PATENT DOCUMENTS

D332,615 S * 1/1993 Fang et al. D15/122
D489,077 S * 4/2004 Bloch D15/127

7,013,544 B2 * 3/2006 Yasuda et al. 29/27 C
D518,497 S * 4/2006 Muraoka et al. D15/199
D636,796 S * 4/2011 Hiroshima et al. D15/122
D667,031 S * 9/2012 Mueller D15/122

FOREIGN PATENT DOCUMENTS

JP 1302328 6/2007
JP 1442919 6/2012
JP 1442955 6/2012

* cited by examiner

Primary Examiner — Patricia Palasik

(74) *Attorney, Agent, or Firm* — Sughrue Mion, PLLC

(57) **CLAIM**

The ornamental design for a laser processing machine, as shown and described.

DESCRIPTION

FIG. 1 is a perspective view of the front, top and right side of a laser processing machine showing our new design; FIG. 2 is a perspective view of the rear, top and left side thereof;

FIG. 3 is a front view thereof;

FIG. 4 is a rear view thereof;

FIG. 5 is a left side view thereof;

FIG. 6 is a right side view thereof;

FIG. 7 is a top view thereof;

FIG. 8 is a bottom view thereof; and,

FIG. 9 is a right side view of a laser processing machine showing a state where a door is open.

The broken lines shown are included for the purpose of illustrating the unclaimed portions of a laser processing machine and form no part of the claimed design.

1 Claim, 8 Drawing Sheets

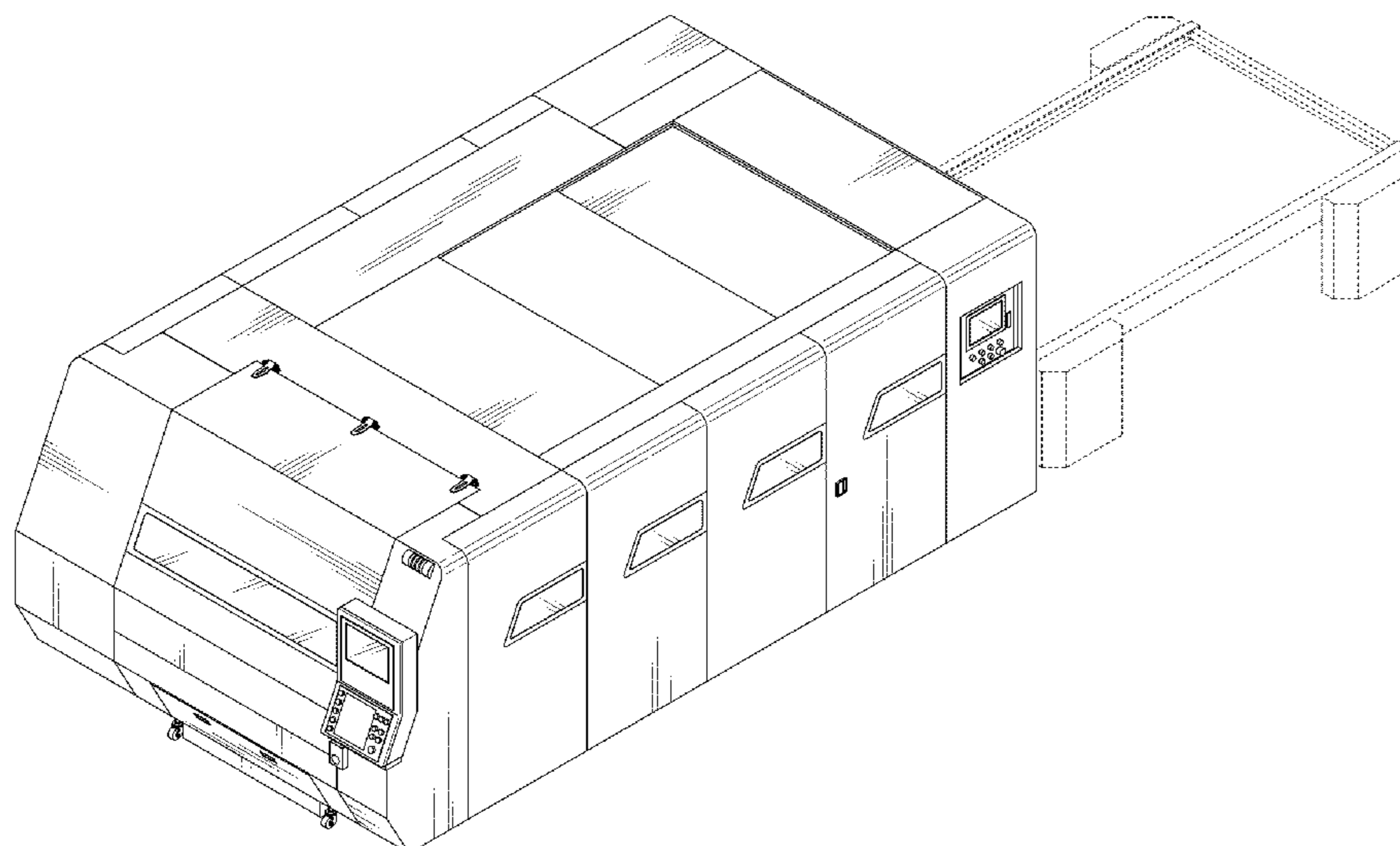
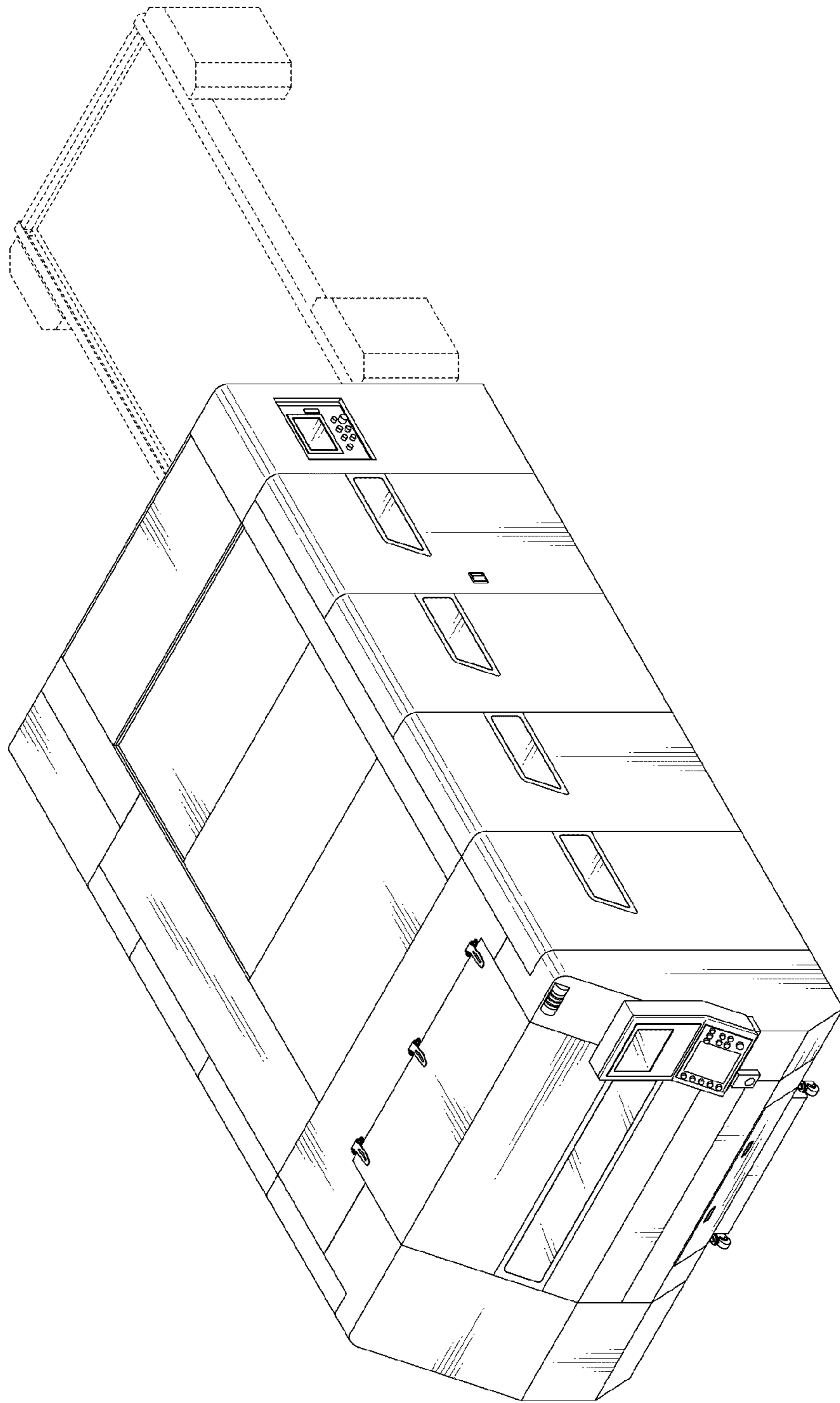

Fig. 1



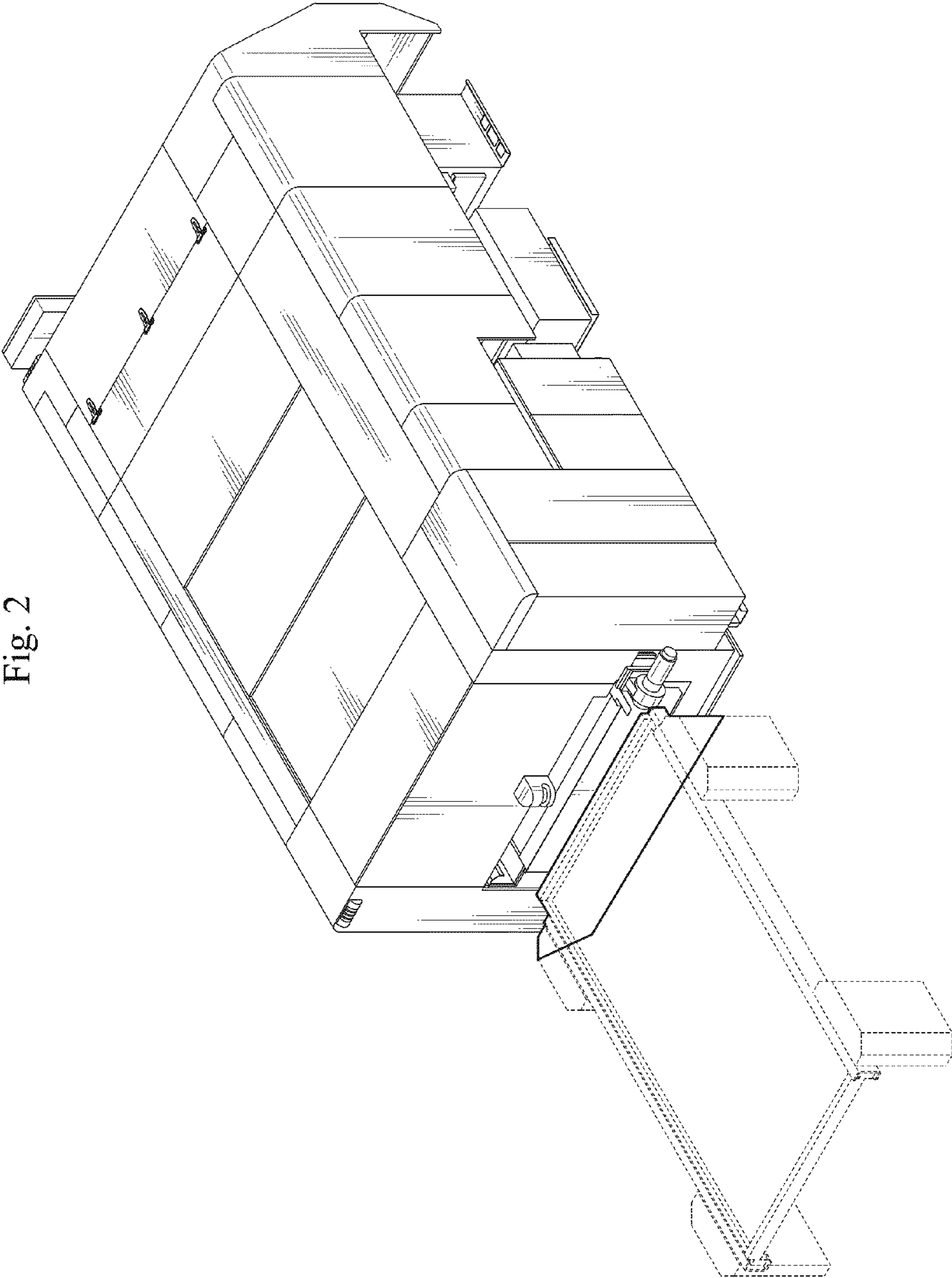

Fig. 2

Fig. 4

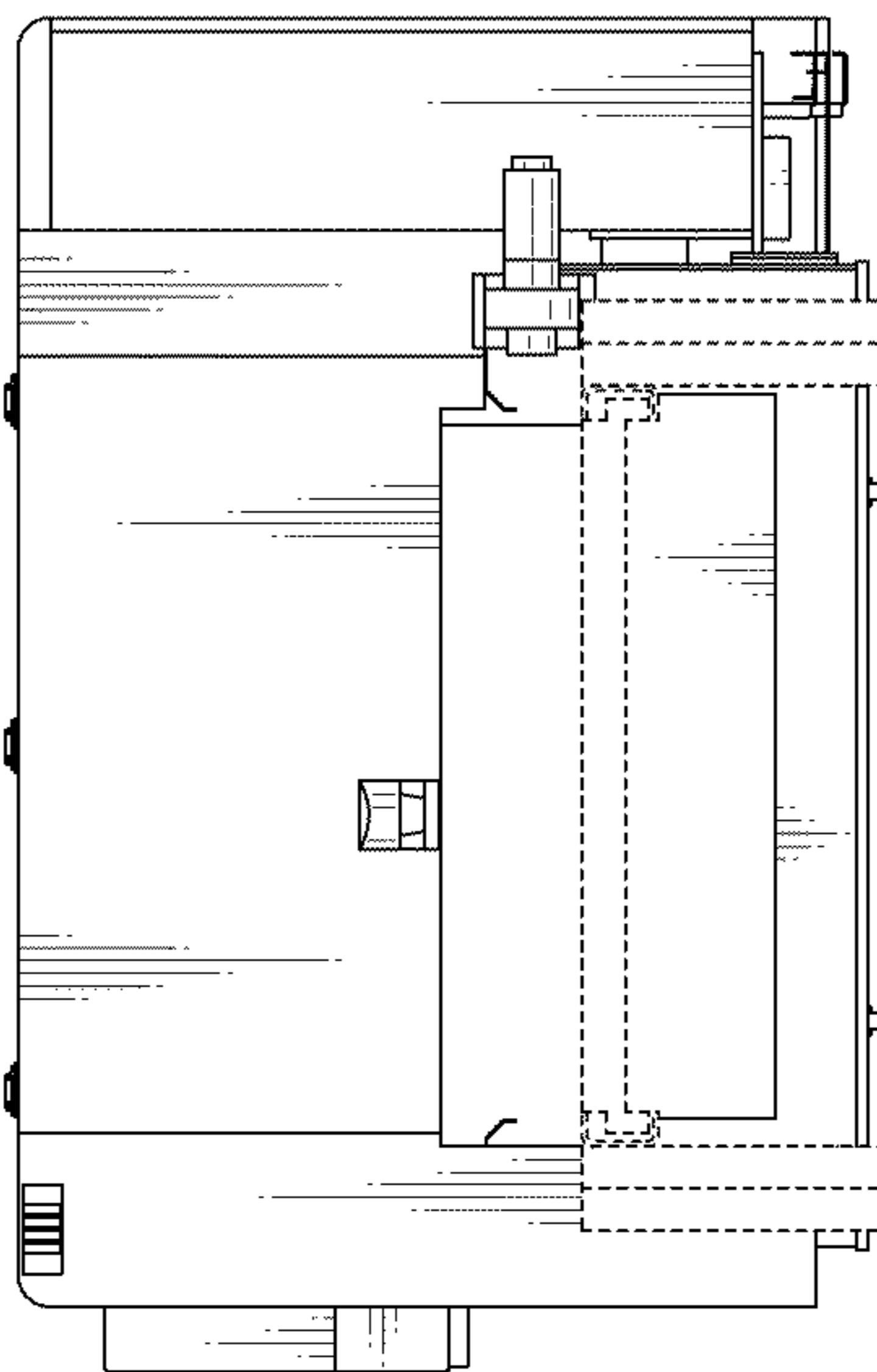

Fig. 3

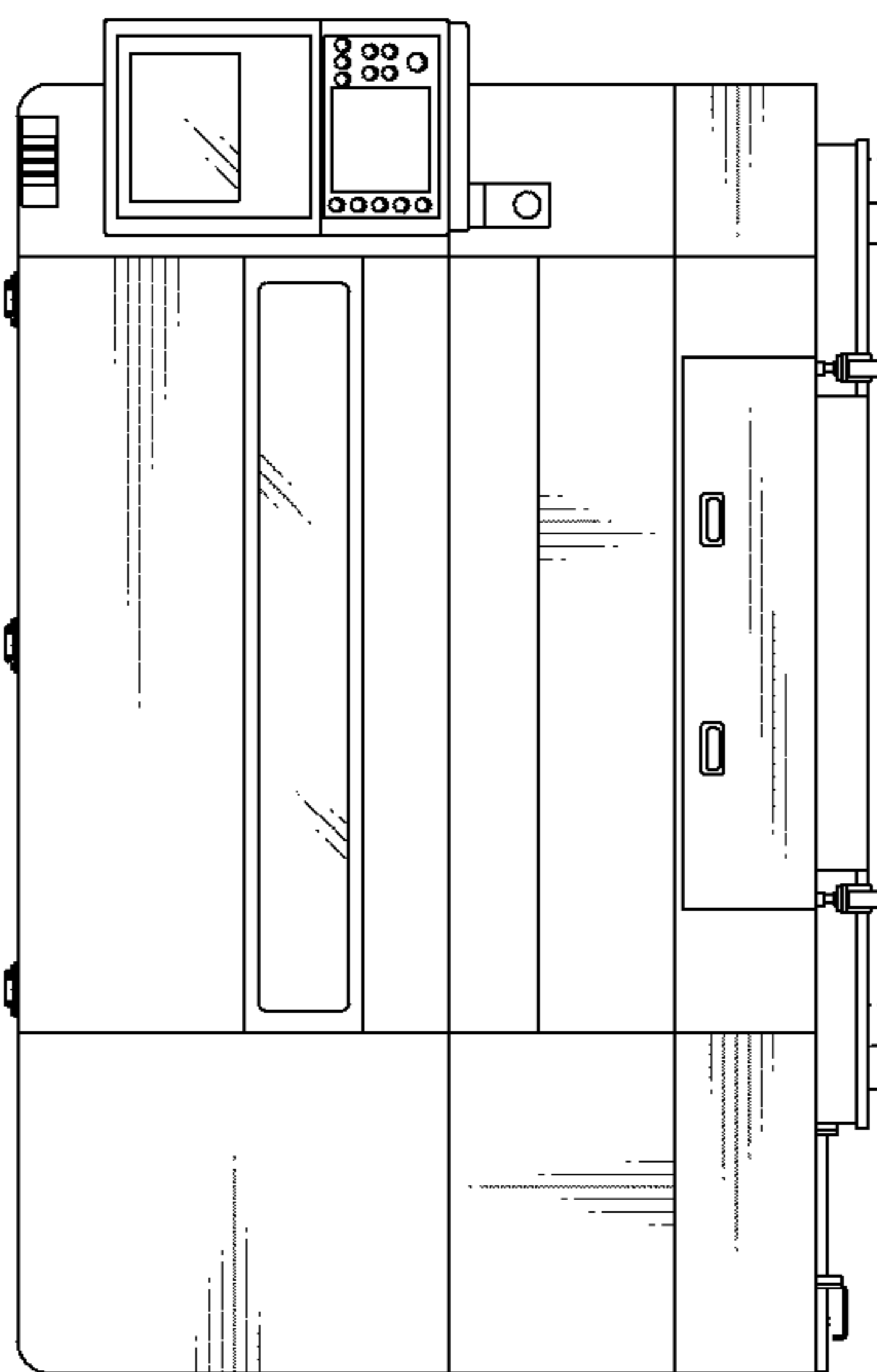

Fig. 5

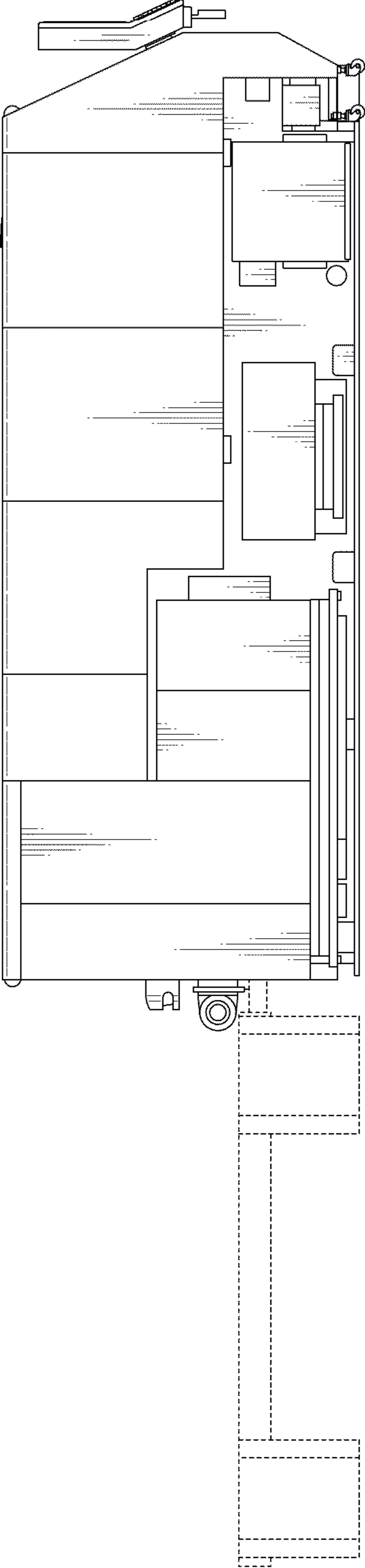

Fig. 6

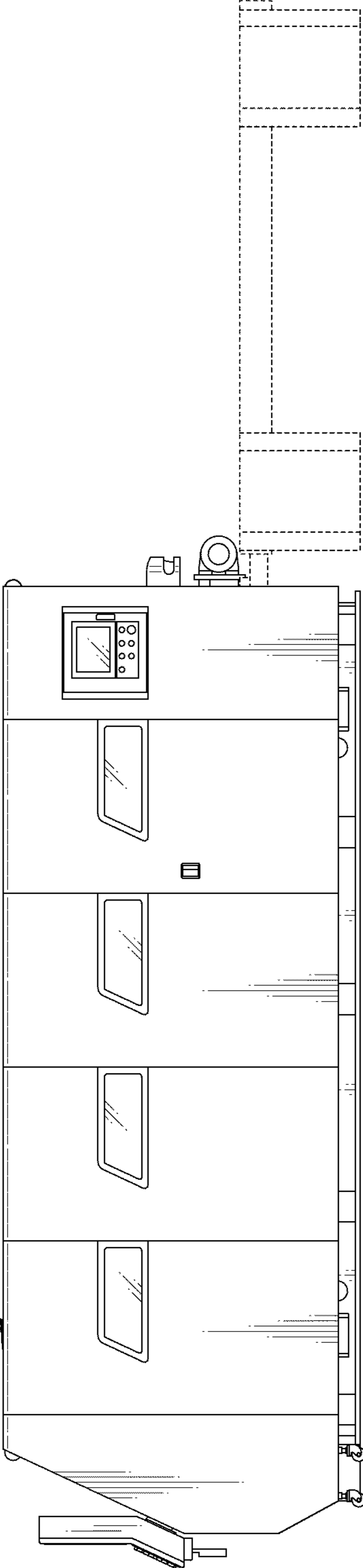

Fig. 7

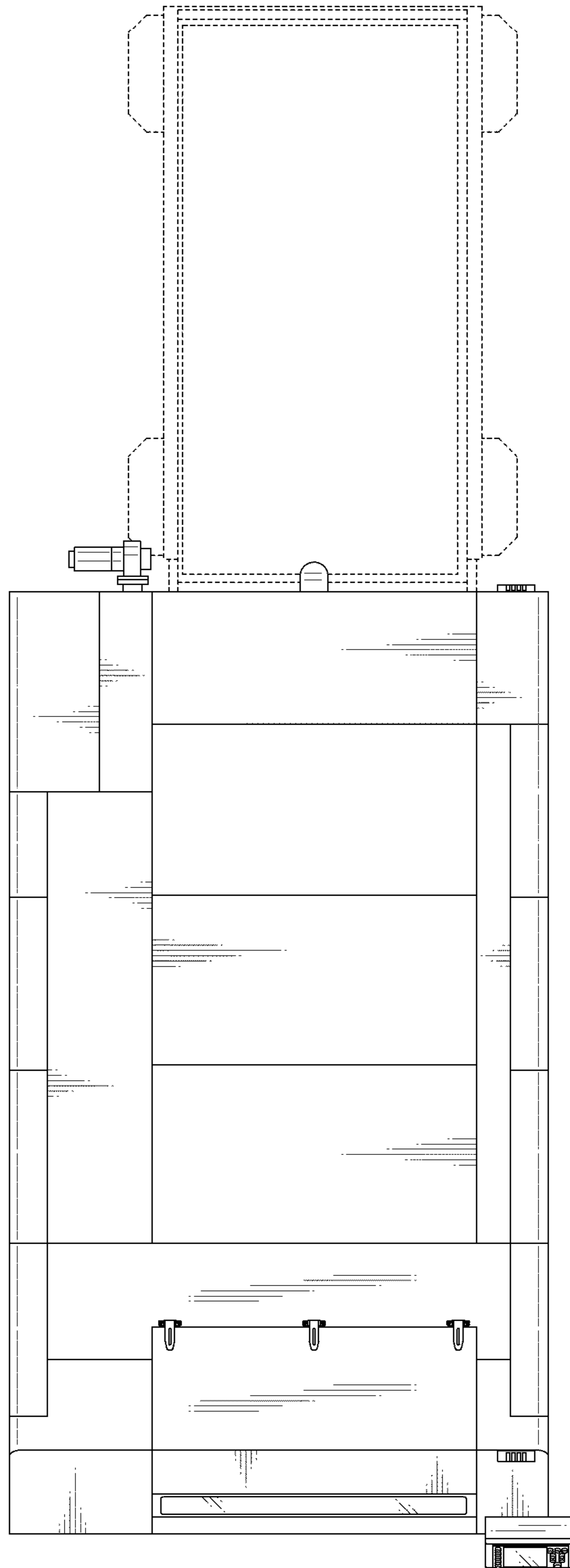

Fig. 8

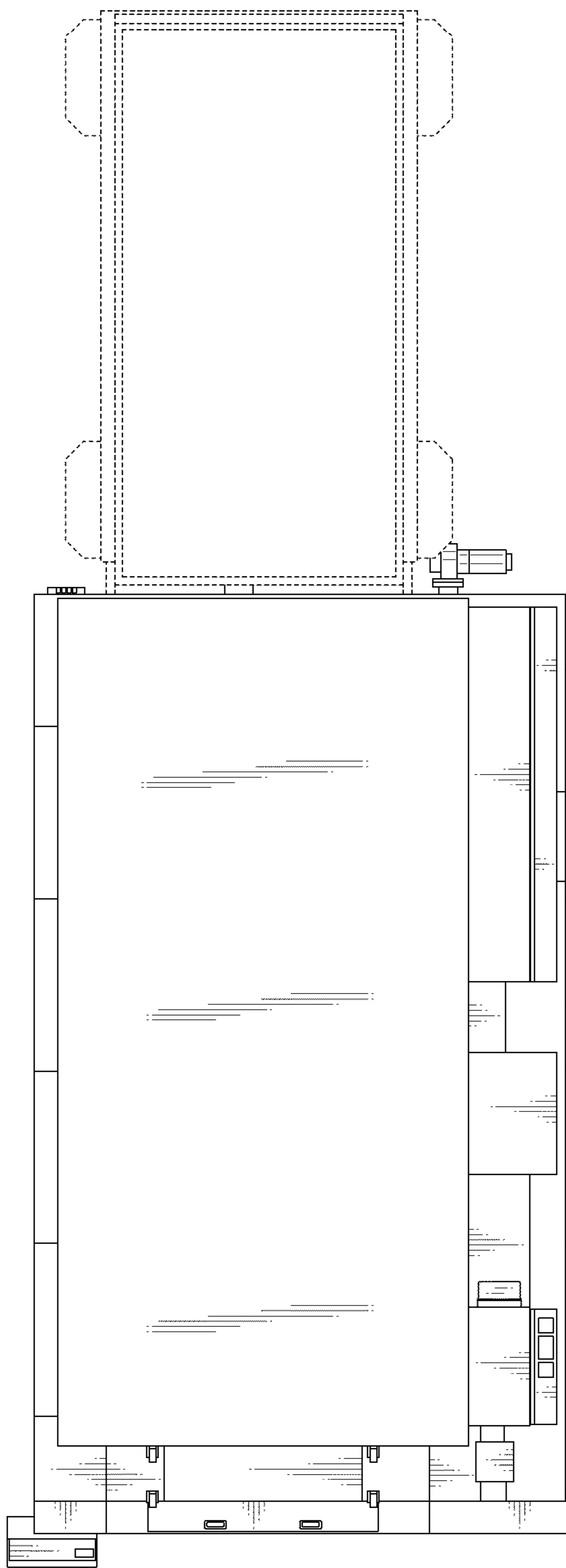

Fig. 9

