



US00D690683S

(12) **United States Design Patent**
Olswang et al.

(10) **Patent No.:** **US D690,683 S**

(45) **Date of Patent:** **** Oct. 1, 2013**

(54) **PORTABLE AUDIO MIXER DOCK**

(71) Applicant: **LOUD Technologies, Inc.**, Woodinville, WA (US)

(72) Inventors: **Benjamin Seth Olswang**, Seattle, WA (US); **Jeffrey M. Humphrey**, Seattle, WA (US); **Frank Larry Frederick**, Monroe, WA (US); **Nathan Pius O'Neill**, Snohomish, WA (US); **Graham Cyril Jordan**, Snohomish, WA (US); **Kent Swendseid**, Bellevue, WA (US); **John Phillip Boudreau**, Seattle, WA (US)

(73) Assignee: **LOUD Technologies Inc.**, Woodinville, WA (US)

(**) Term: **14 Years**

(21) Appl. No.: **29/433,548**

(22) Filed: **Oct. 1, 2012**

Related U.S. Application Data

(63) Continuation of application No. 29/411,212, filed on Jan. 18, 2012, now Pat. No. Des. 685,766.

(51) **LOC (9) Cl.** **14-03**

(52) **U.S. Cl.**
USPC **D14/217**

(58) **Field of Classification Search**
USPC D14/162, 167-169, 175, 188, 196-198, D14/217, 257, 258, 434, 496; D13/163, D13/164; 84/625, 660, 697; 455/350; 381/119
See application file for complete search history.

(56) **References Cited**

U.S. PATENT DOCUMENTS

D493,162 S *	7/2004	Amiya	D14/217
D553,608 S	10/2007	Williamson	
D561,177 S *	2/2008	Mittersinker et al.	D14/217
D565,031 S *	3/2008	Duncan Seil et al.	D14/217
D583,798 S *	12/2008	Iijima et al.	D14/168
D643,410 S *	8/2011	Blyth et al.	D14/217
D650,783 S *	12/2011	Ausfeld et al.	D14/434
D654,077 S	2/2012	Radin	
D663,302 S	7/2012	Radin	
D663,303 S	7/2012	Radin	
D663,734 S	7/2012	Radin	

* cited by examiner

Primary Examiner — Keli L Hill

(74) *Attorney, Agent, or Firm* — Christensen O'Connor Johnson Kindness PLLC

(57) **CLAIM**

The ornamental design for a portable audio mixer dock, as shown and described.

DESCRIPTION

FIG. 1 is an isometric view of the design of the present application taken from above, with a computing device shown in broken line docked with the portable audio mixer dock;

FIG. 2 is a bottom isometric view of the design of FIG. 1;

FIG. 3 is a top view of the design of FIG. 1;

FIG. 4 is a bottom view of the design of FIG. 1;

FIG. 5 is an end view of the design of FIG. 1;

FIG. 6 is an end view of the design of FIG. 1 taken from the opposite end of the design; and,

FIG. 7 is a side view of the design of FIG. 1.

The elements depicted in broken lines in the figures are included for environmental purposes only, and form no part of the claimed design.

1 Claim, 6 Drawing Sheets

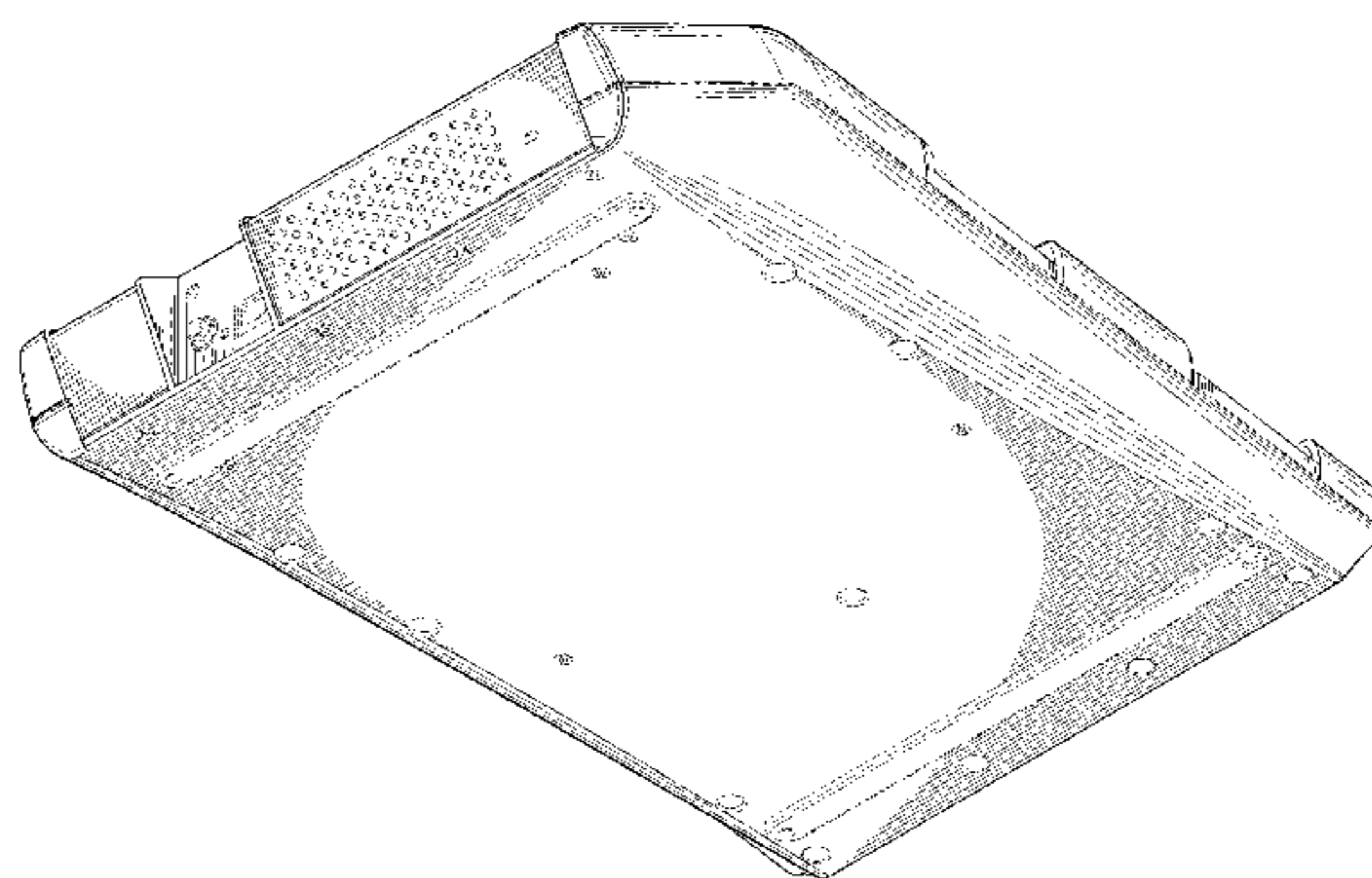
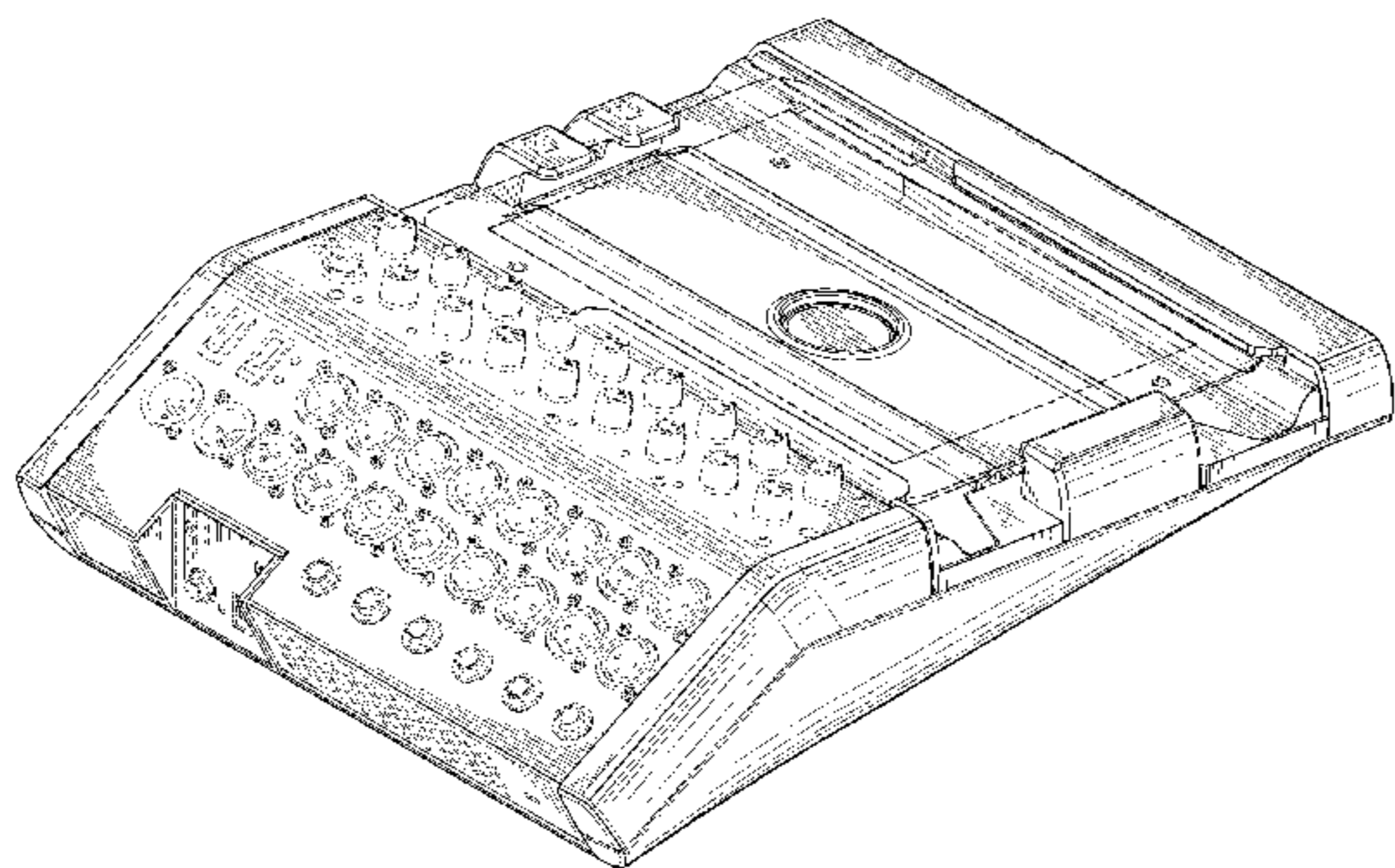

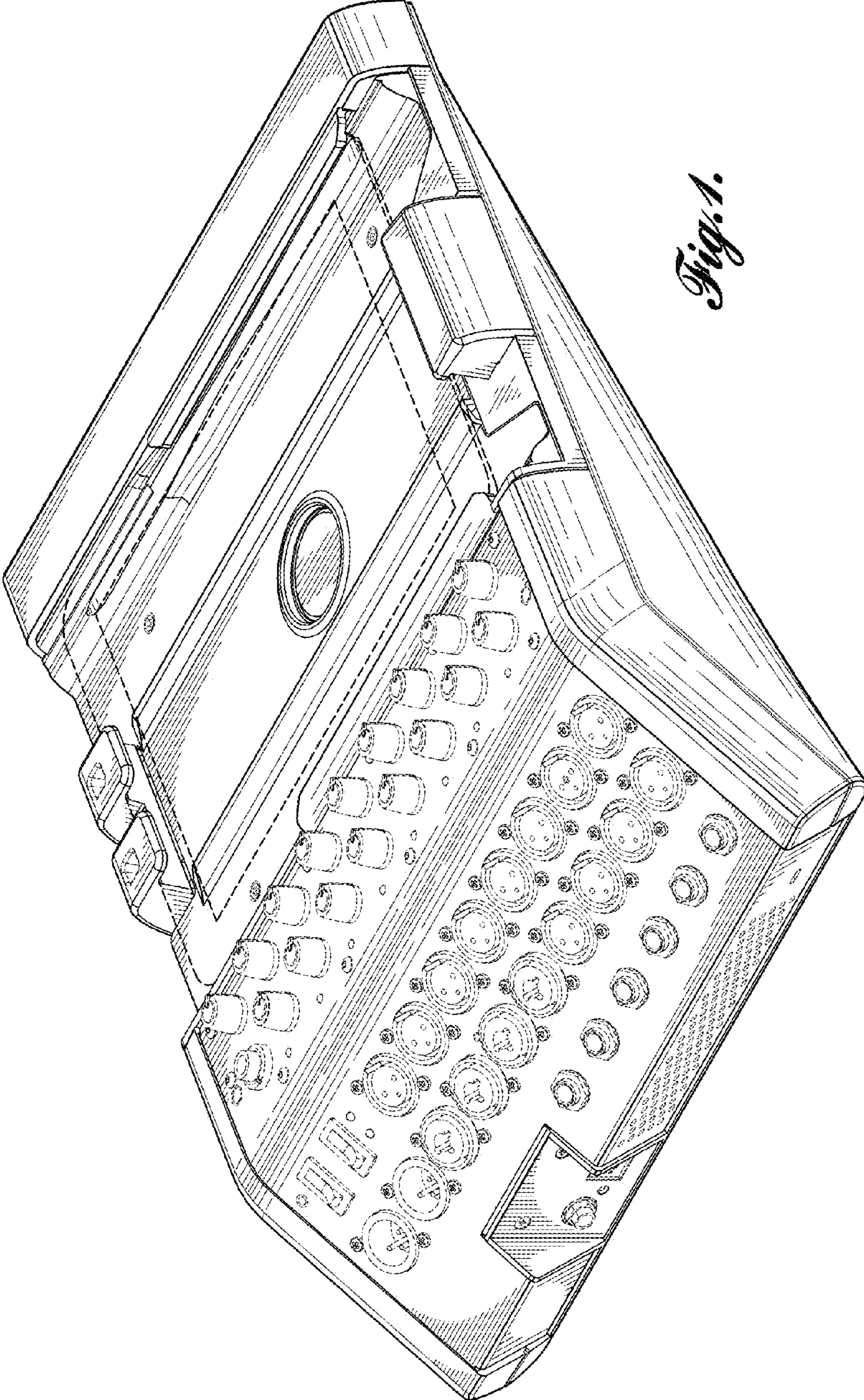

Fig. 1.

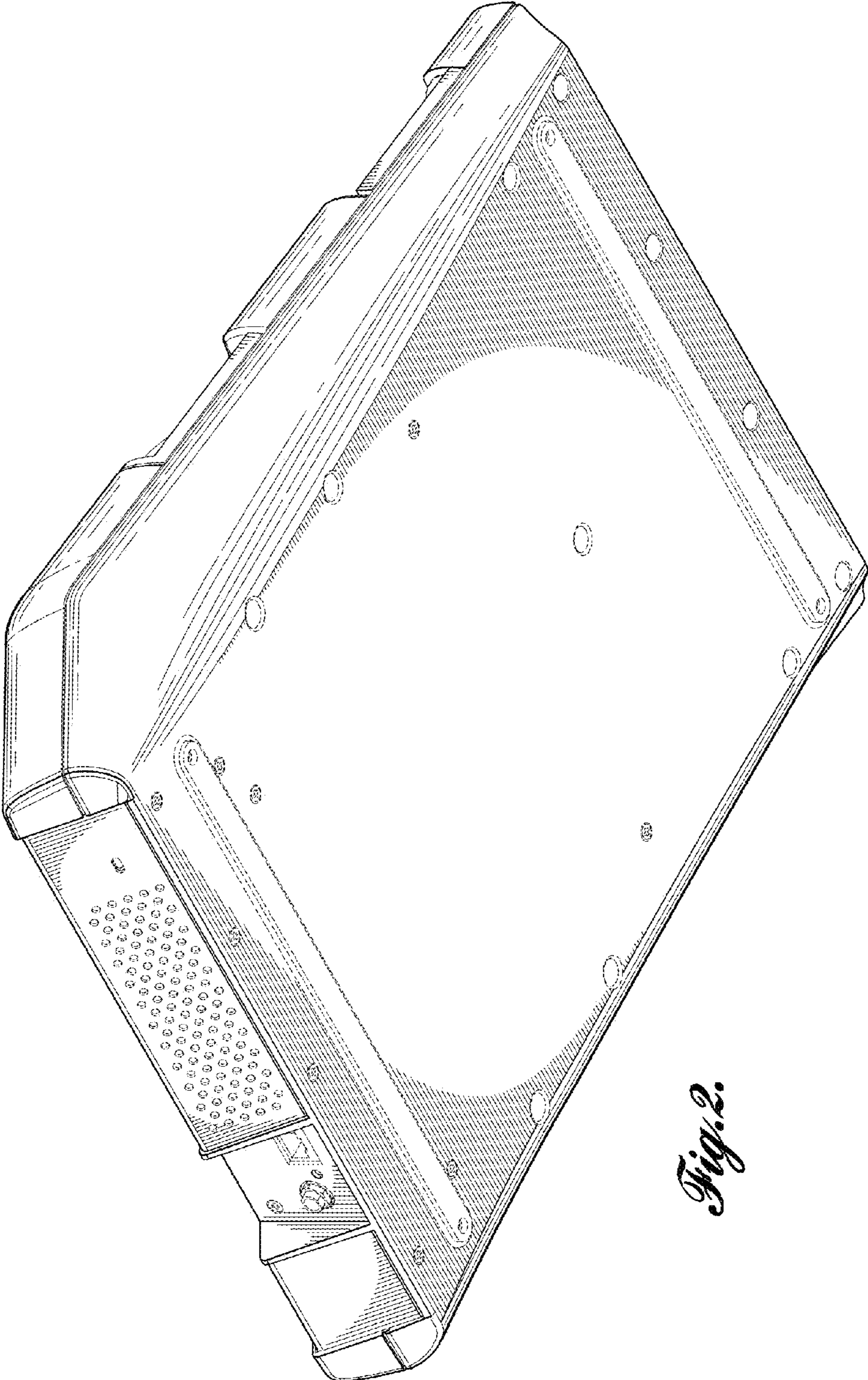

Fig. 2.

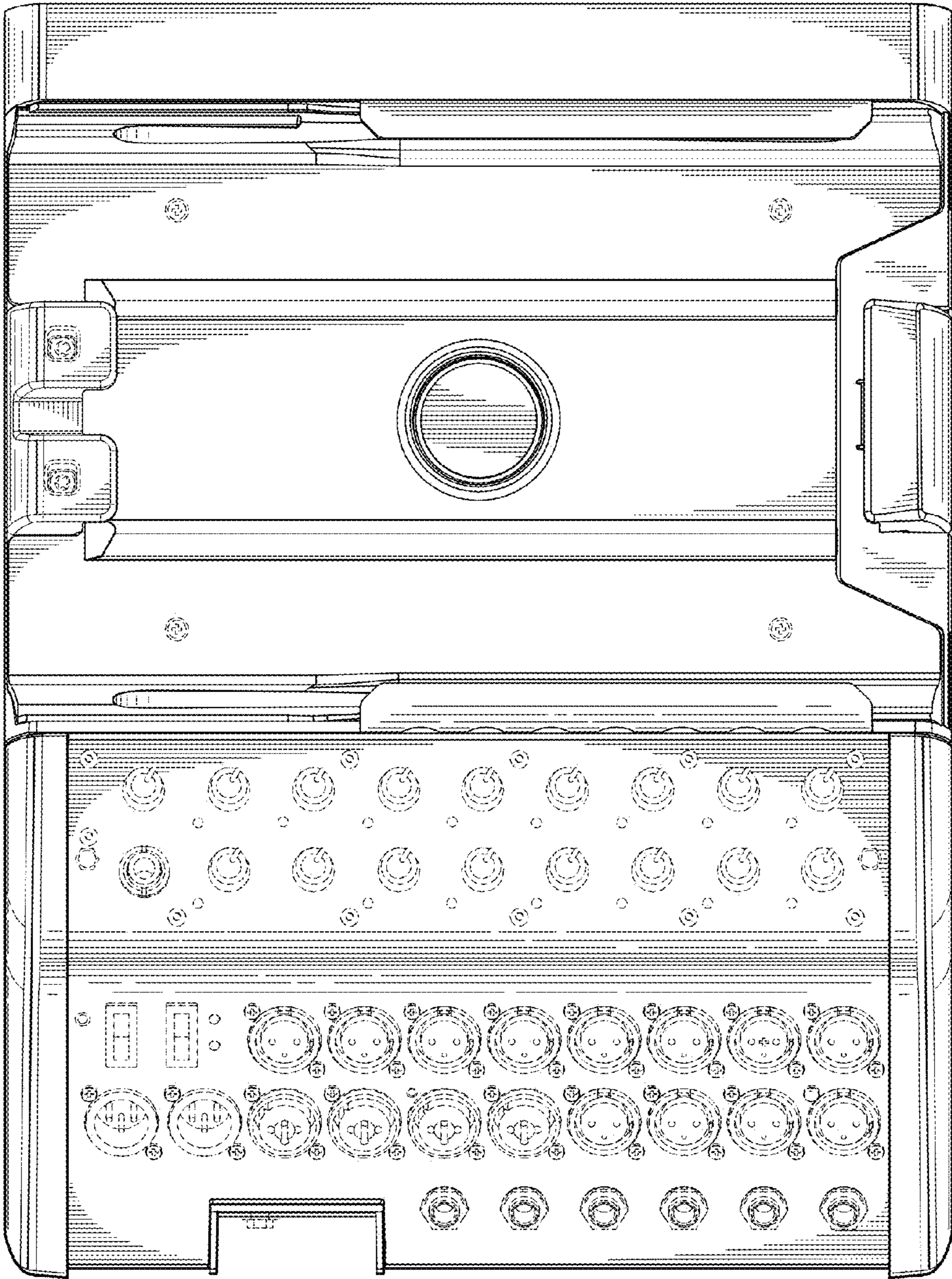

Fig. 3.

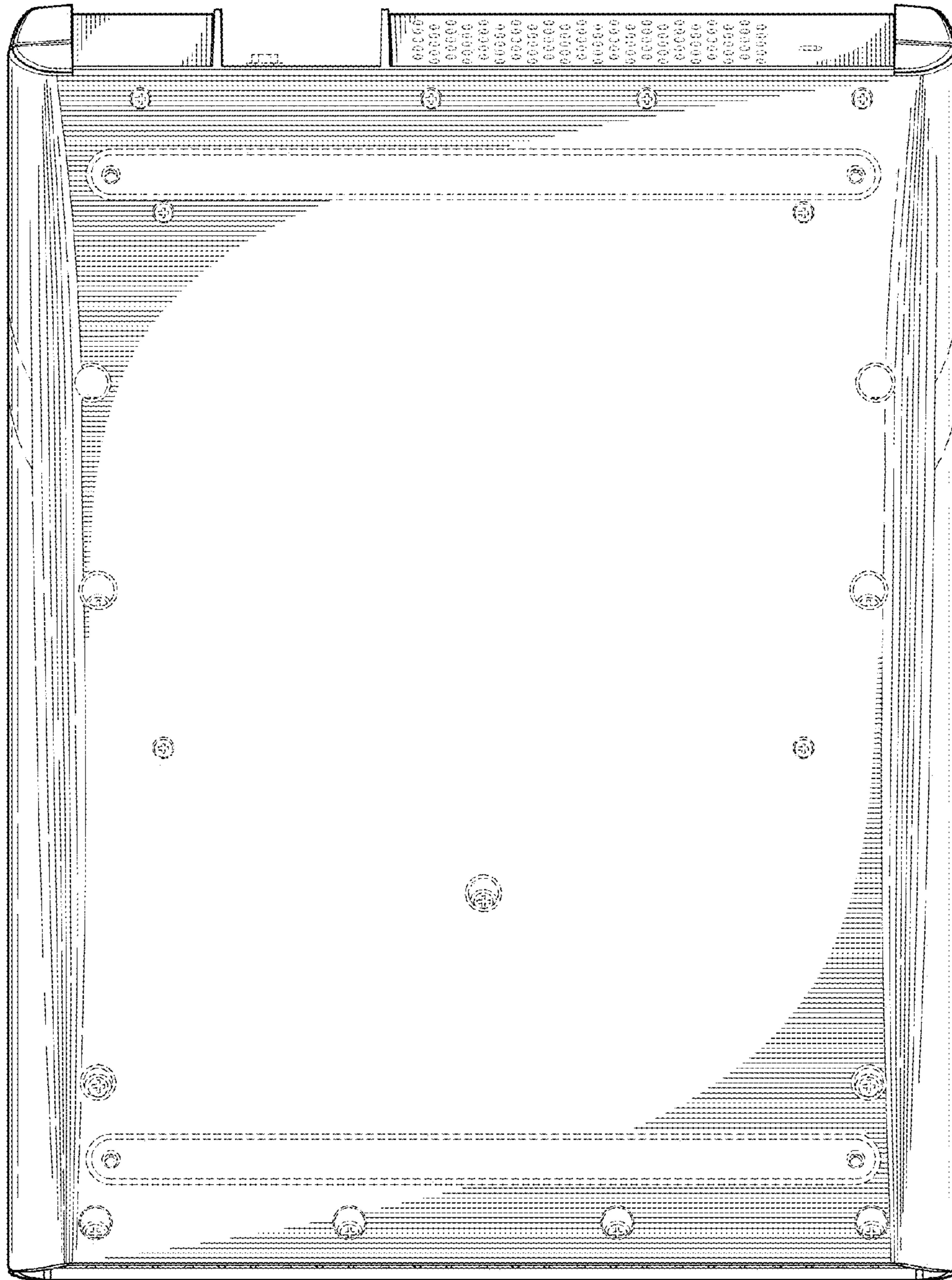

Fig. 4.

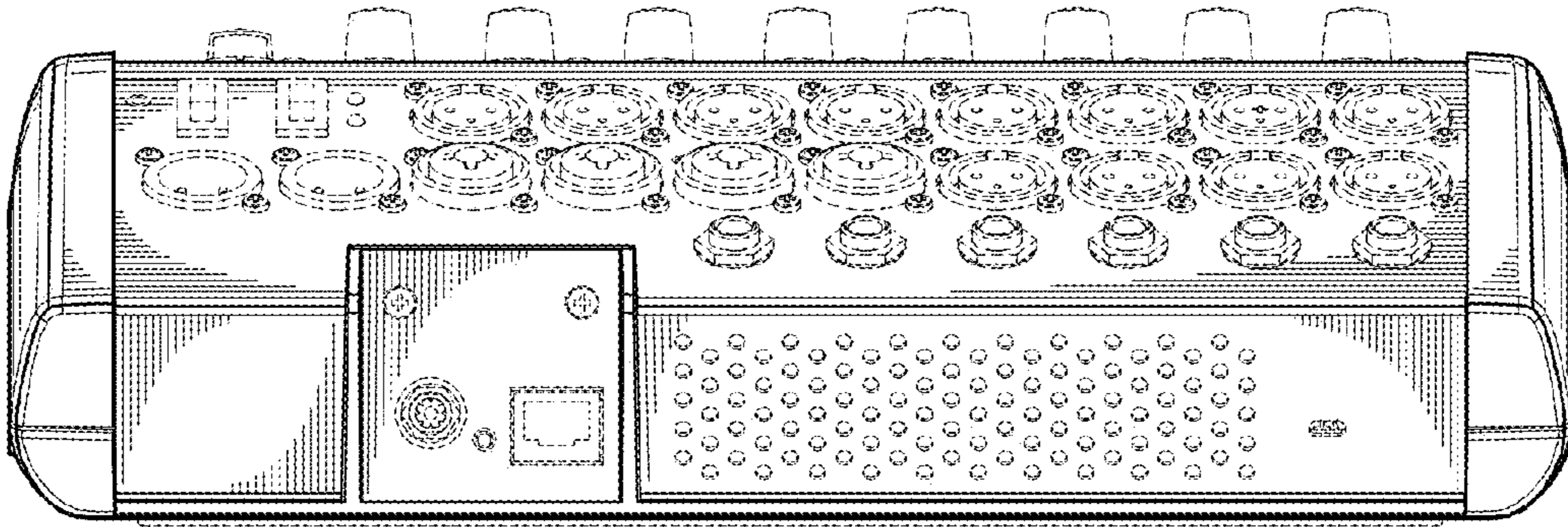

Fig. 5.

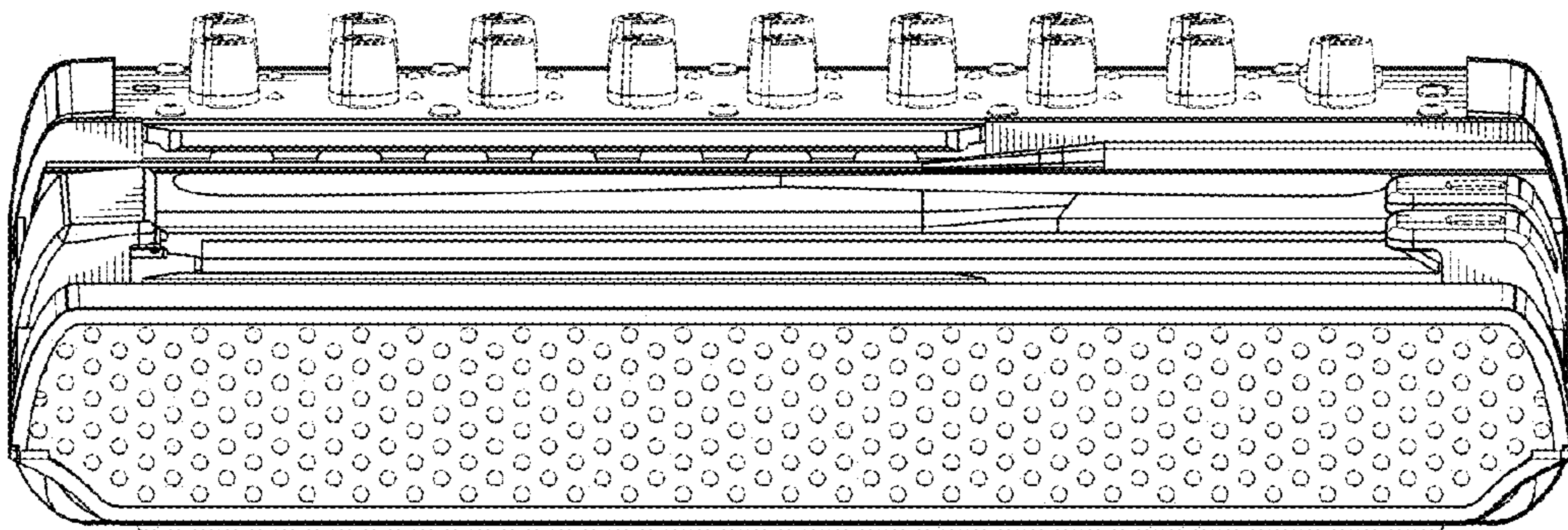

Fig. 6.

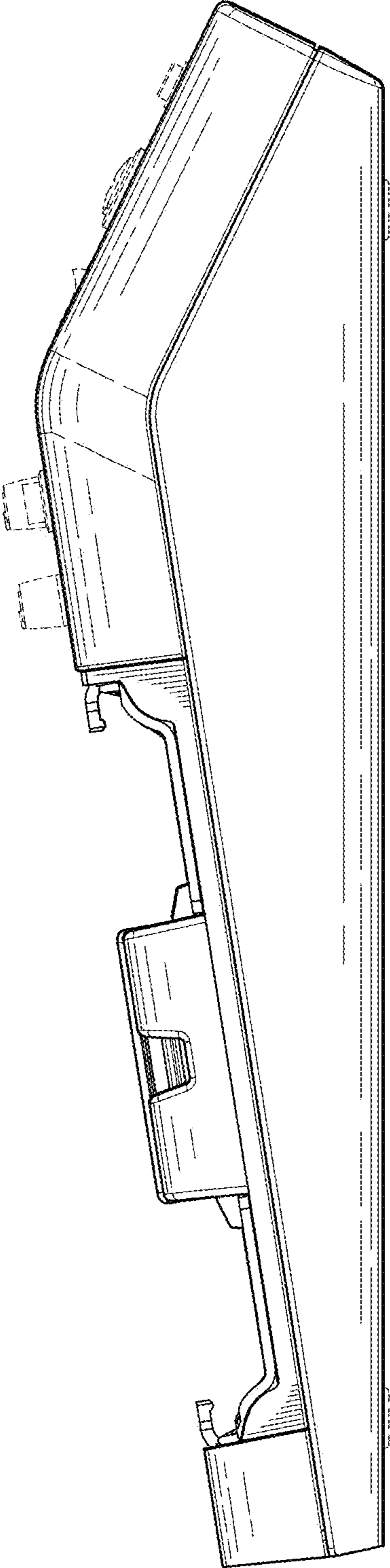

Fig. 7.