



US00D690673S

(12) **United States Design Patent**
Birdwell

(10) **Patent No.:** **US D690,673 S**
(45) **Date of Patent:** **** Oct. 1, 2013**

- (54) **AUDIO ENUNCIATOR COVER FRAME**
- (75) Inventor: **Timothy Gale Birdwell**, Lafayette, TN (US)
- (73) Assignee: **HeathCo, LLC**, Bowling Green, KY (US)
- (**) Term: **14 Years**
- (21) Appl. No.: **29/357,234**
- (22) Filed: **Mar. 9, 2010**
- (51) **LOC (9) Cl.** **14-03**
- (52) **U.S. Cl.**
USPC **D14/121; D14/217; D10/116.1**
- (58) **Field of Classification Search**
USPC D10/104.1, 406.1, 116.1, 118, 118.2, D10/121; D13/133, 152, 154; 340/574, 340/693.12, 384.1, 384.3–384.7, 384.73; D14/217
See application file for complete search history.

- 2006/0290477 A1 12/2006 Cole, Sr. et al.
- 2007/0003099 A1 1/2007 Madni et al.
- 2008/0112571 A1 5/2008 Bradicich et al.
- 2008/0221956 A1 9/2008 Bloch et al.
- 2011/0116676 A1* 5/2011 Birdwell 381/386

* cited by examiner

Primary Examiner — Keli L Hill

(74) *Attorney, Agent, or Firm* — Fitch, Even, Tabin & Flannery, LLP

(57) **CLAIM**

I claim the ornamental design for an audio enunciator cover frame, as shown and described.

DESCRIPTION

FIG. 1 is a first perspective view showing a first embodiment of my new design comprising an audio enunciator cover frame;

FIG. 2 is a second perspective view of the audio enunciator cover frame of FIG. 1, rotated clockwise ninety degrees;

FIG. 3 is a third perspective view of the audio enunciator cover frame of FIG. 2, rotated clockwise ninety degrees;

FIG. 4 is a fourth perspective view of the audio enunciator cover frame of FIG. 3, rotated clockwise ninety degrees;

FIG. 5 is a side elevational view of the audio enunciator cover frame of FIG. 1, the other side view being identical thereto;

FIG. 6 is a front elevational view of the audio enunciator cover frame of FIG. 1, the rear elevational view being identical thereto;

FIG. 7 is a top plan view of the audio enunciator cover frame of FIG. 1;

FIG. 8 is a bottom plan view of the audio enunciator cover frame of FIG. 1;

FIG. 9 is a first perspective view showing a second embodiment of my new design comprising an audio enunciator cover frame;

FIG. 10 is a second perspective view of the audio enunciator cover frame of FIG. 9, rotated clockwise ninety degrees;

FIG. 11 is a third perspective view of the audio enunciator cover frame of FIG. 10, rotated clockwise ninety degrees;

FIG. 12 is a fourth perspective view of the audio enunciator cover frame of FIG. 11, rotated clockwise ninety degrees;

(56) **References Cited**

U.S. PATENT DOCUMENTS

4,181,924	A	1/1980	Thomas et al.	
D287,704	S	1/1987	Wheeler	
4,971,758	A *	11/1990	Suzuki et al.	420/472
D337,513	S *	7/1993	Soloway et al.	D8/373
5,519,572	A	5/1996	Luo	
5,537,716	A	7/1996	Komamura	
D382,502	S	8/1997	Ryan	
5,774,041	A	6/1998	Xydis et al.	
D410,404	S	6/1999	Scheibe	
5,909,169	A *	6/1999	Lin	340/384.73
D439,186	S	3/2001	Kovens et al.	
6,750,760	B2	6/2004	Albritton et al.	
D512,422	S *	12/2005	Sato et al.	D14/363
D567,692	S *	4/2008	Meyers et al.	D10/118
D569,343	S *	5/2008	Hung et al.	D13/133
D611,863	S	3/2010	Kato	
D643,457	S *	8/2011	DeLong	D16/237
D656,763	S *	4/2012	Fejt	D6/503
D676,346	S *	2/2013	Birdwell	D10/116.1
2002/0126851	A1	9/2002	Lo et al.	
2003/0090369	A1 *	5/2003	Albritton et al.	340/392.1
2005/0147271	A1	7/2005	Shain	

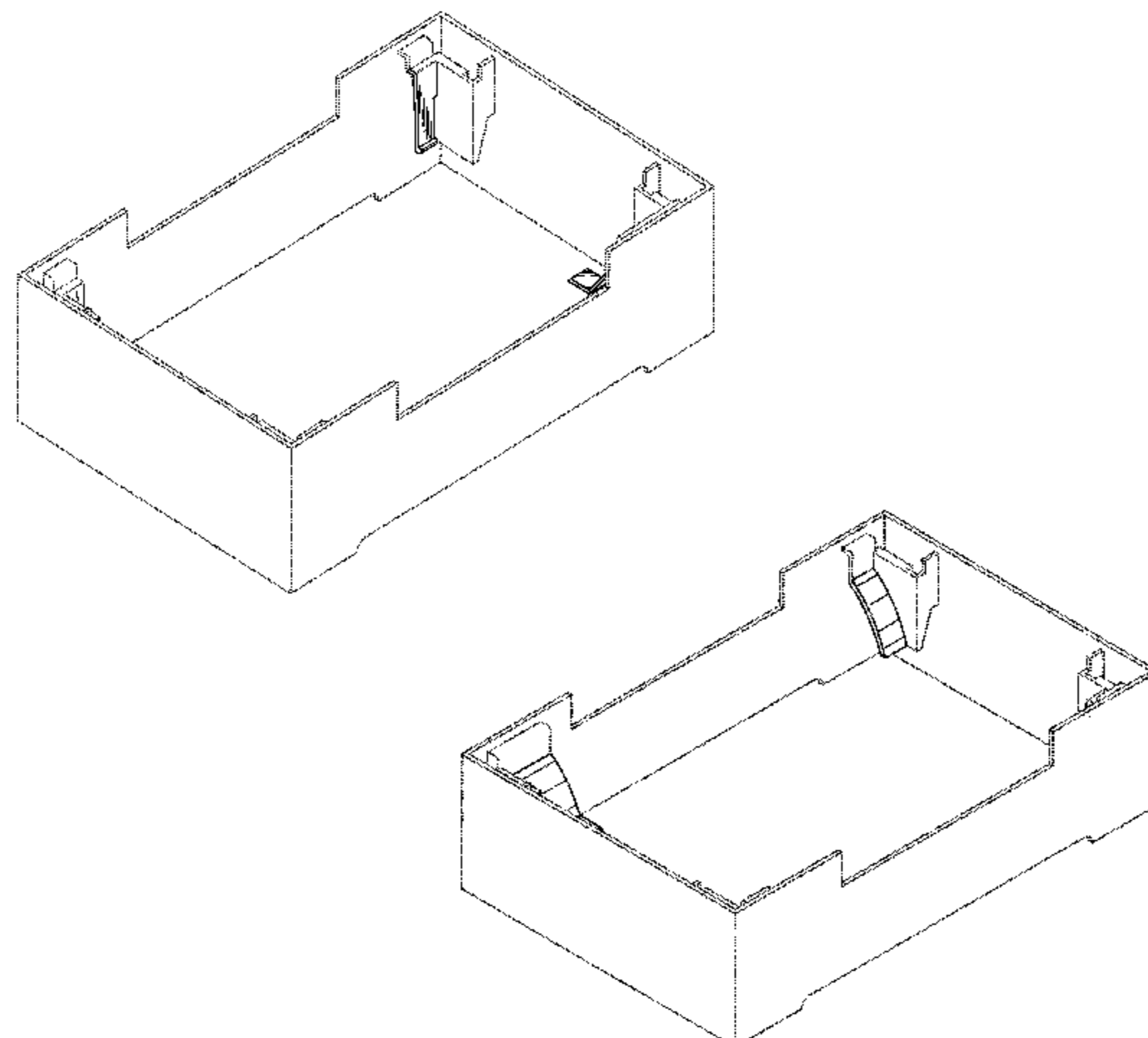

FIG. 13 is a side elevational view of the audio enunciator cover frame of FIG. 9, the other side view being identical thereto;

FIG. 14 is a front elevational view of the audio enunciator cover frame of FIG. 9, the rear elevational view being identical thereto;

FIG. 15 is a top plan view of the audio enunciator cover frame of FIG. 9;

FIG. 16 is a bottom plan view of the audio enunciator cover frame of FIG. 9;

FIG. 17 is a first perspective view showing a third embodiment of my new design comprising an audio enunciator cover frame;

FIG. 18 is a second perspective view of the audio enunciator cover frame of FIG. 17, rotated clockwise ninety degrees;

FIG. 19 is a third perspective view of the audio enunciator cover frame of FIG. 18, rotated clockwise ninety degrees;

FIG. 20 is a fourth perspective view of the audio enunciator cover frame of FIG. 19, rotated clockwise ninety degrees;

FIG. 21 is a side elevational view of the audio enunciator cover frame of FIG. 17, the other side view being identical thereto;

FIG. 22 is a front elevational view of the audio enunciator cover frame of FIG. 17, the rear elevational view being identical thereto;

FIG. 23 is a top plan view of the audio enunciator cover frame of FIG. 17; and,

FIG. 24 is a bottom plan view of the audio enunciator cover frame of FIG. 17.

The broken lines shown are included for the purpose of illustrating the unclaimed portions of the audio enunciator cover frame and form no part of the claim.

1 Claim, 18 Drawing Sheets

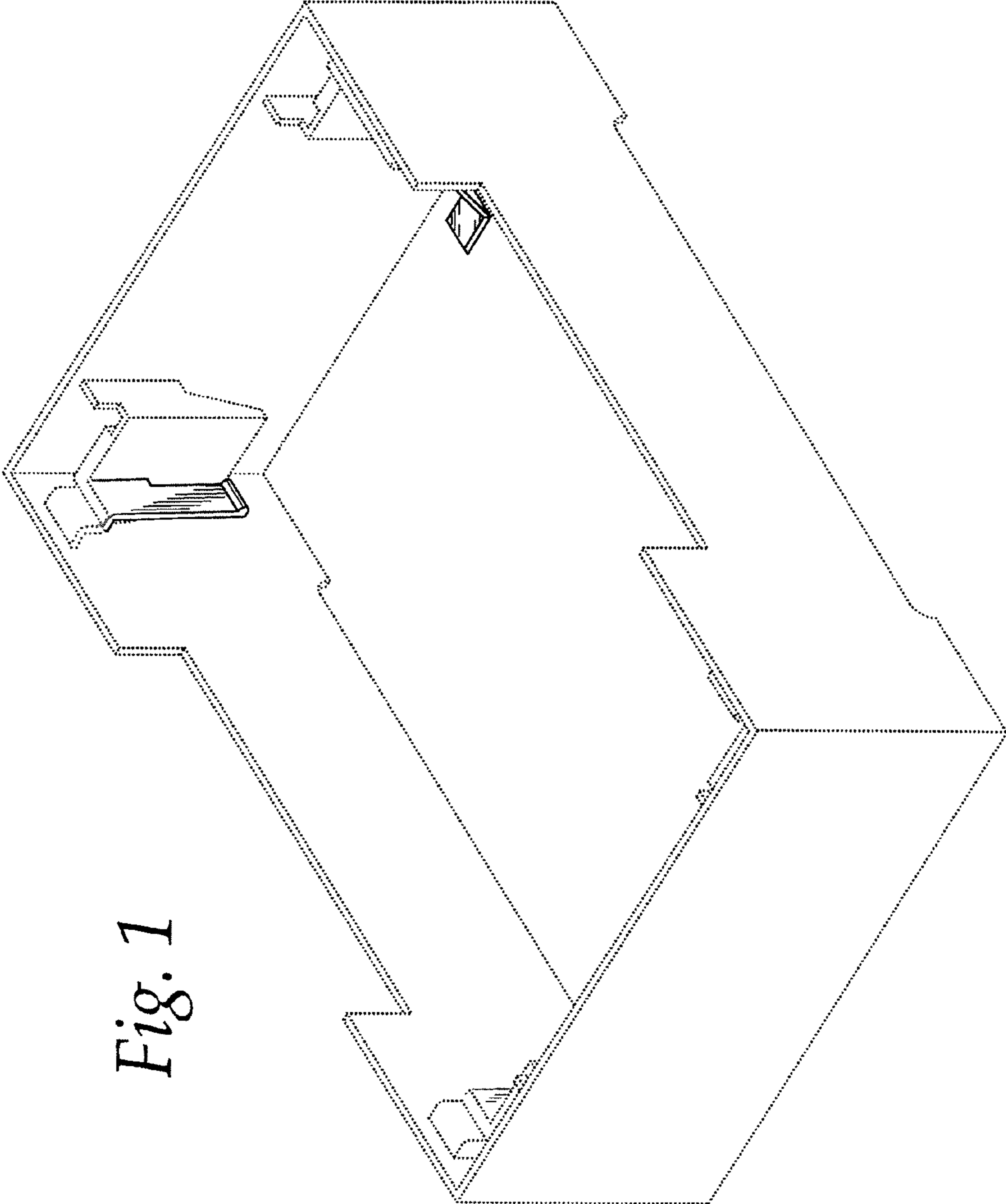

Fig. 1

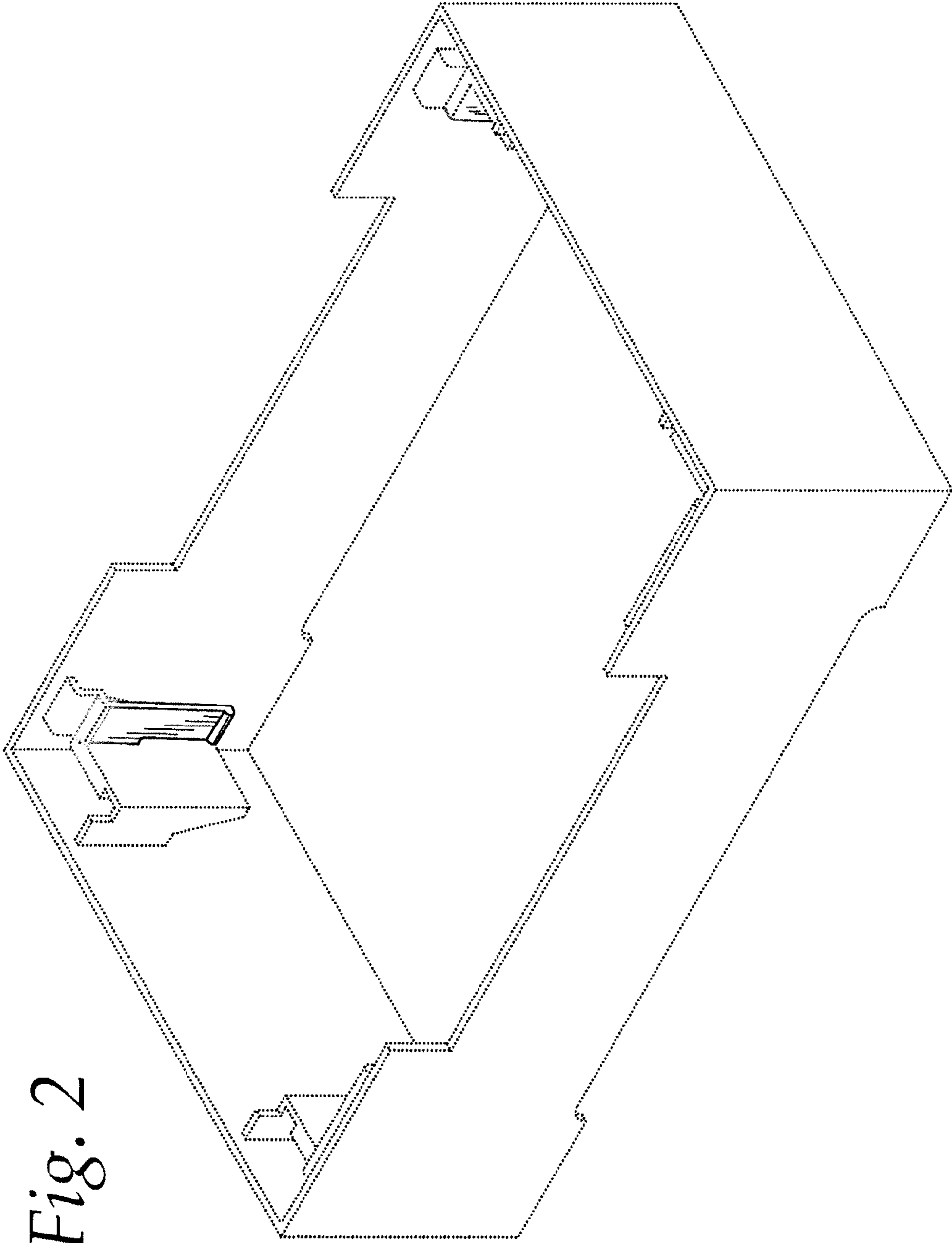

Fig. 2

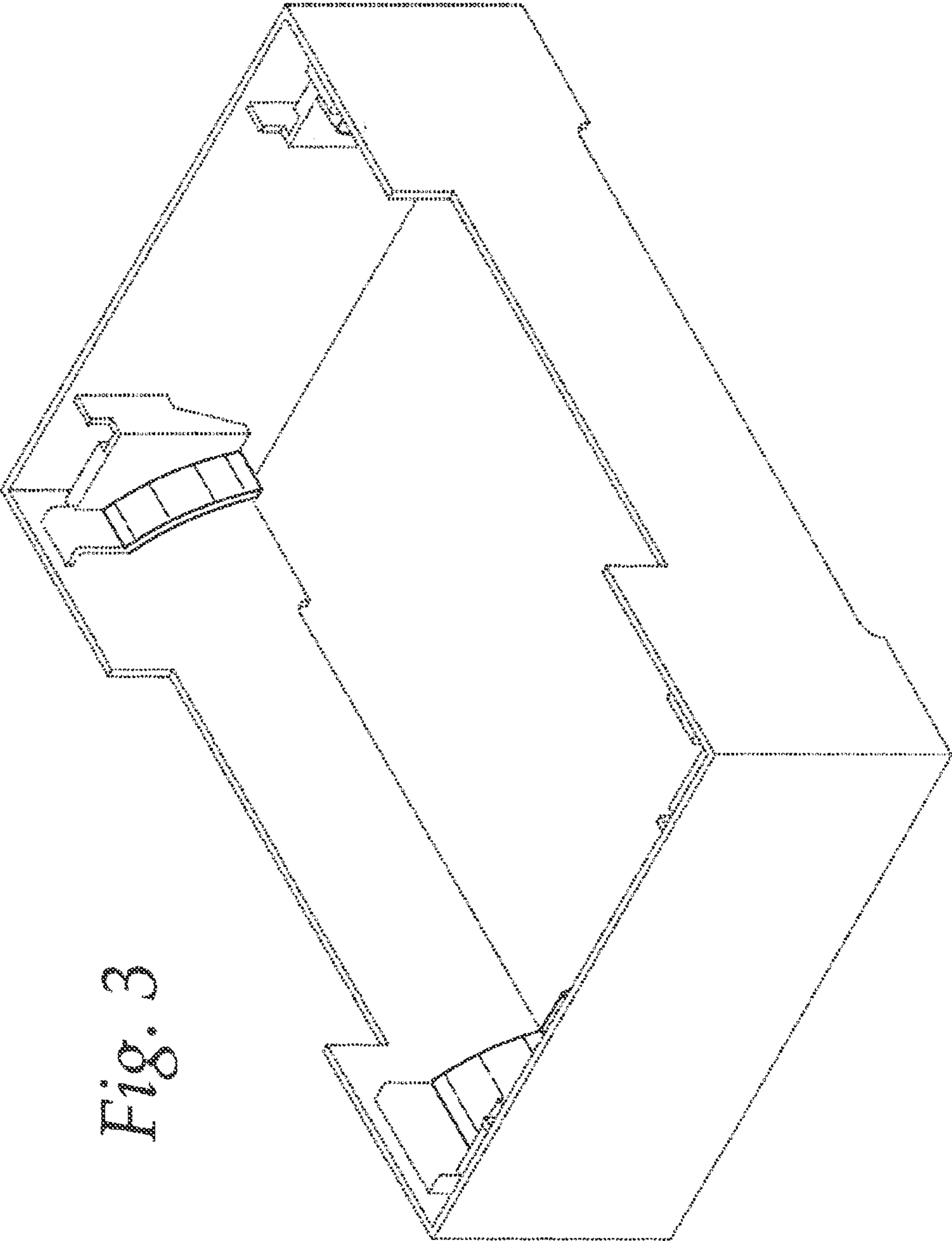
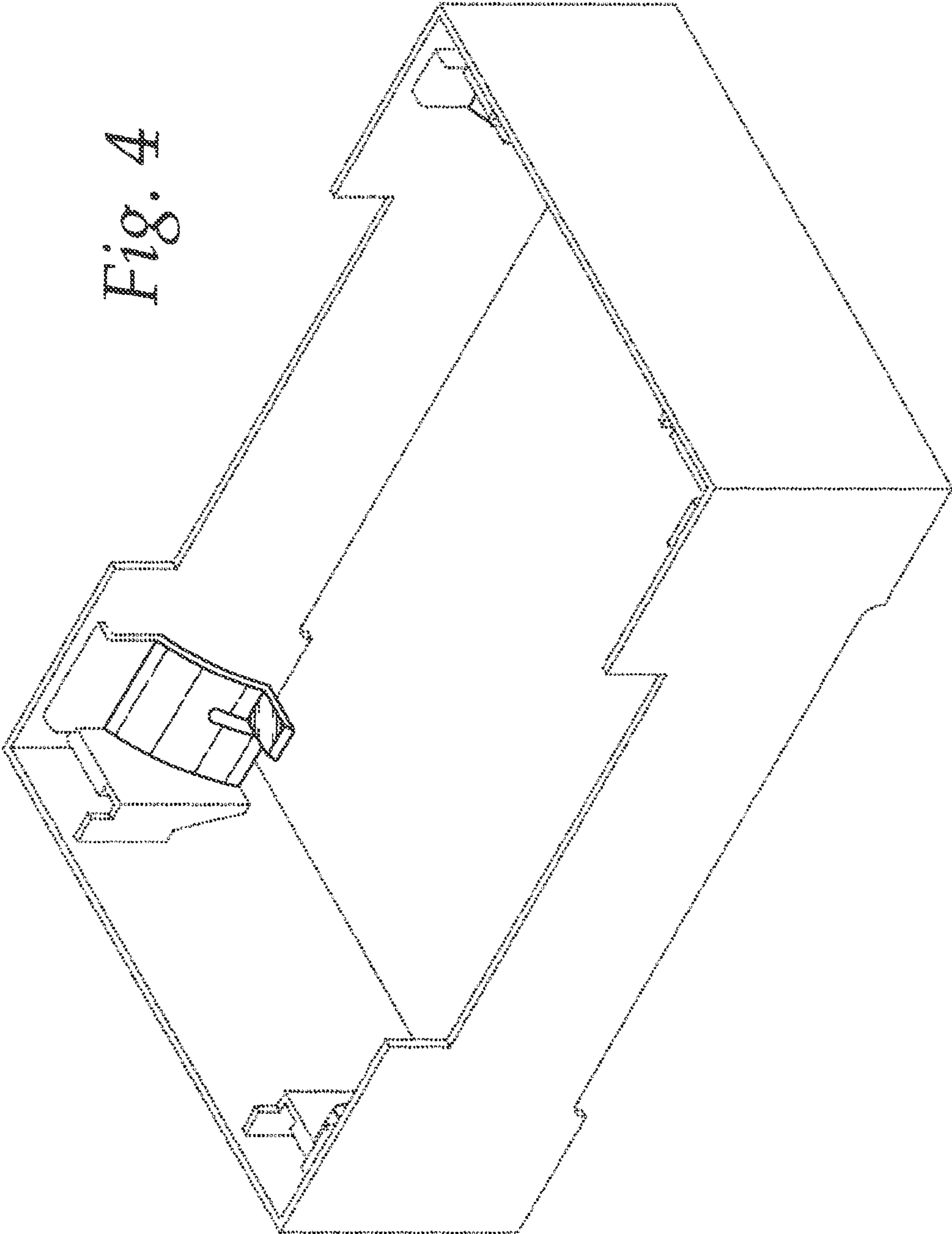

Fig. 3

Fig. 4



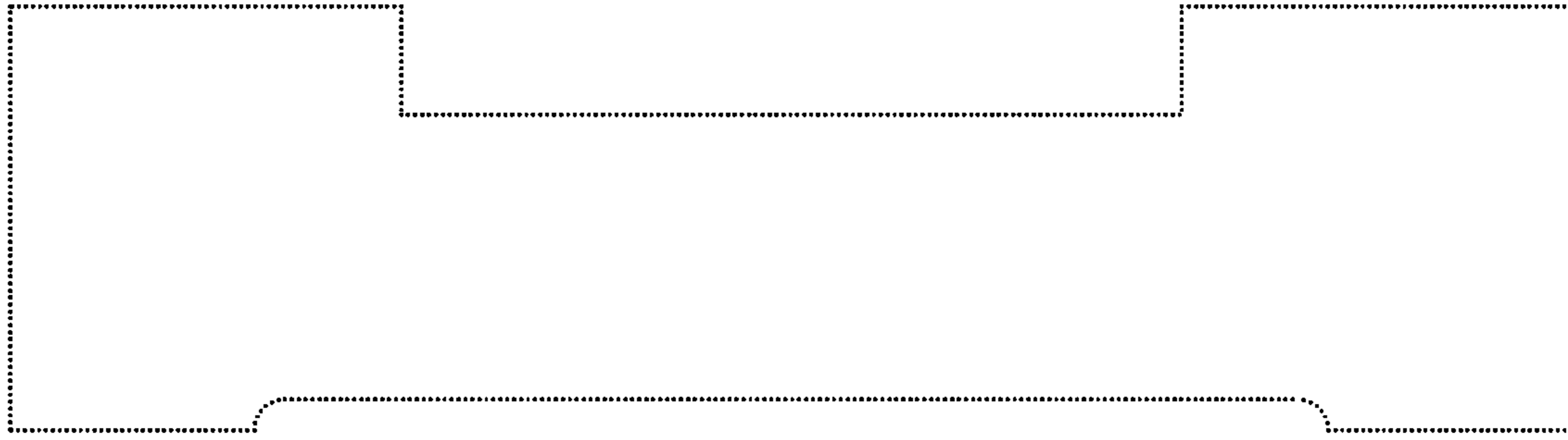

Fig. 5



Fig. 6

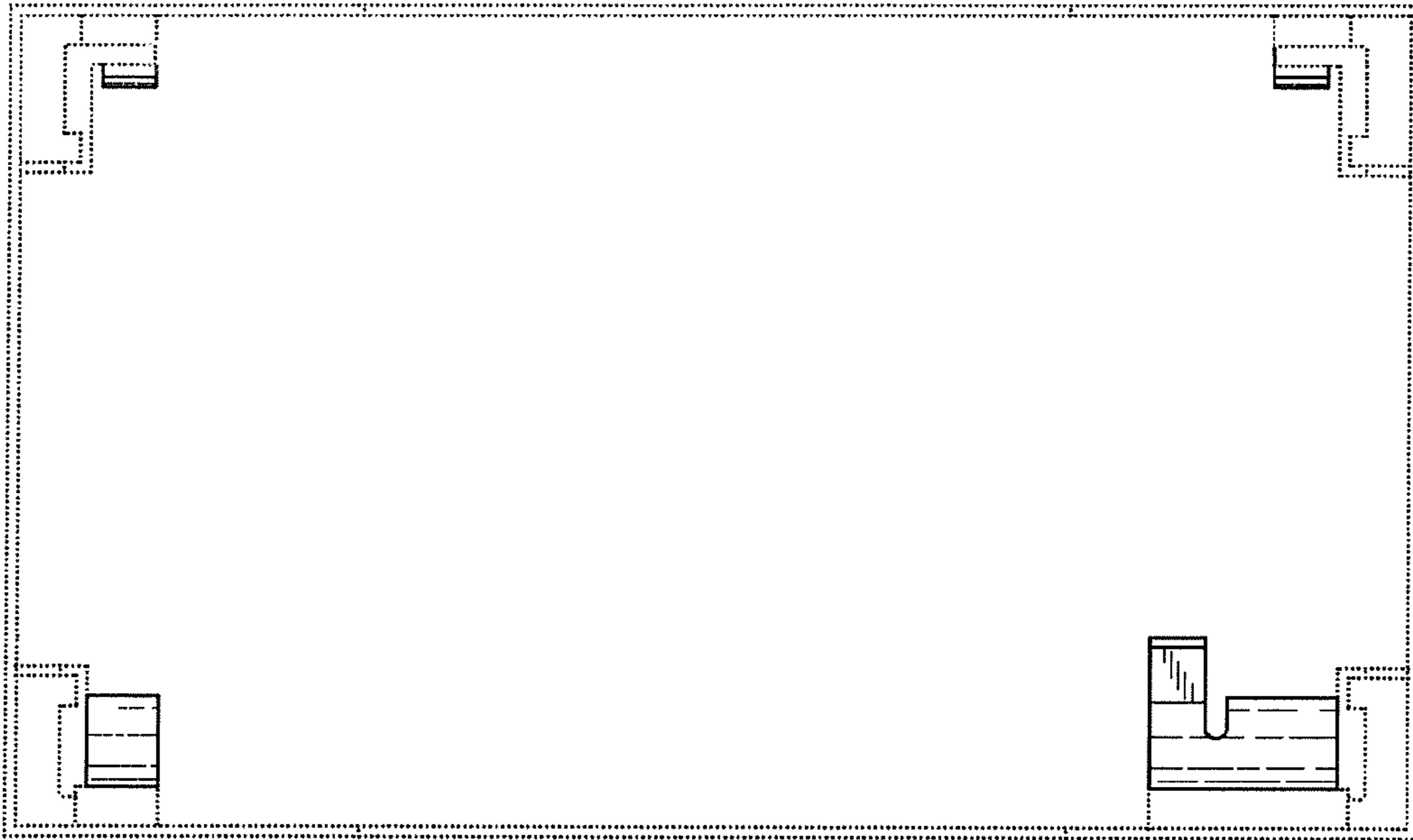

Fig. 7

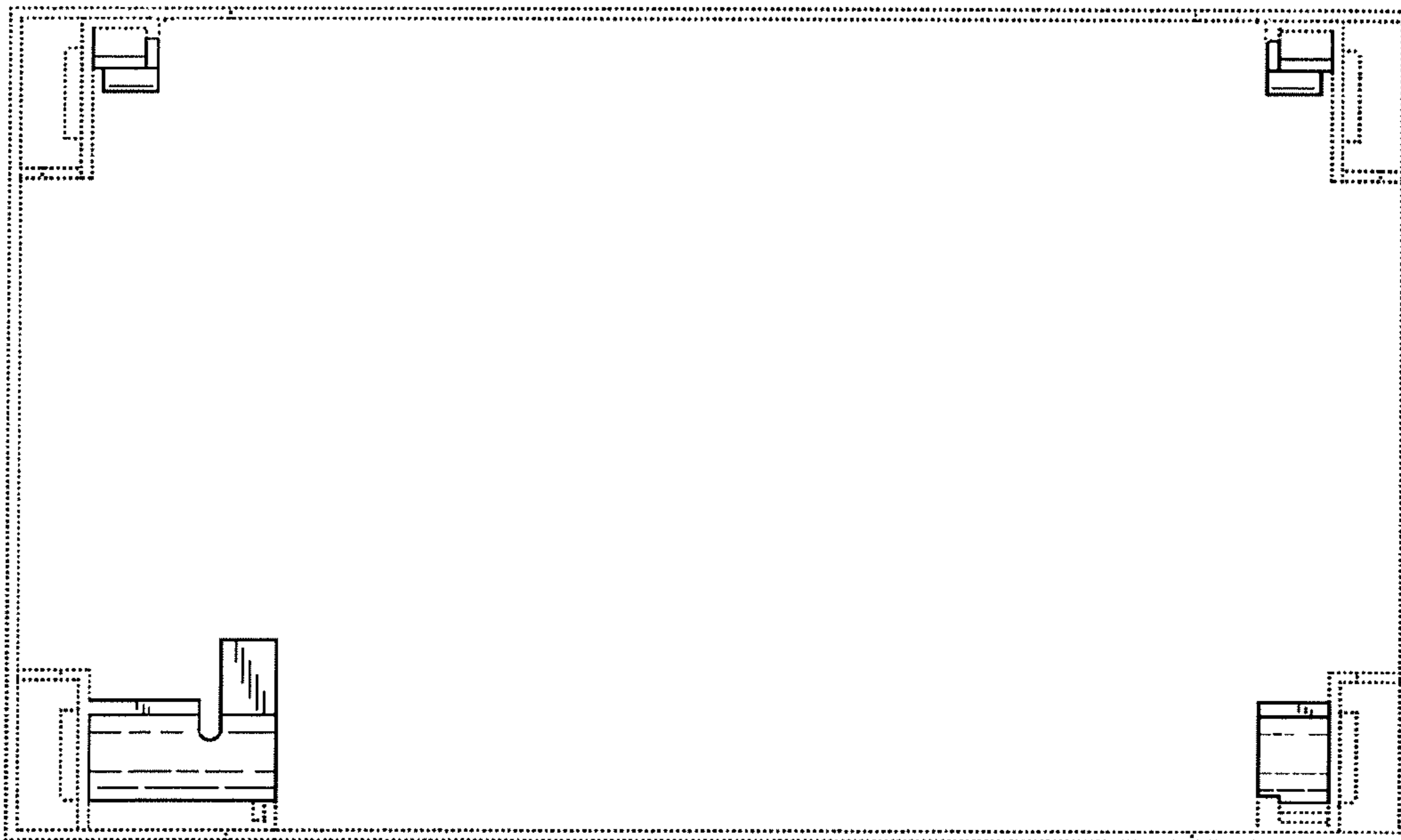

Fig. 8

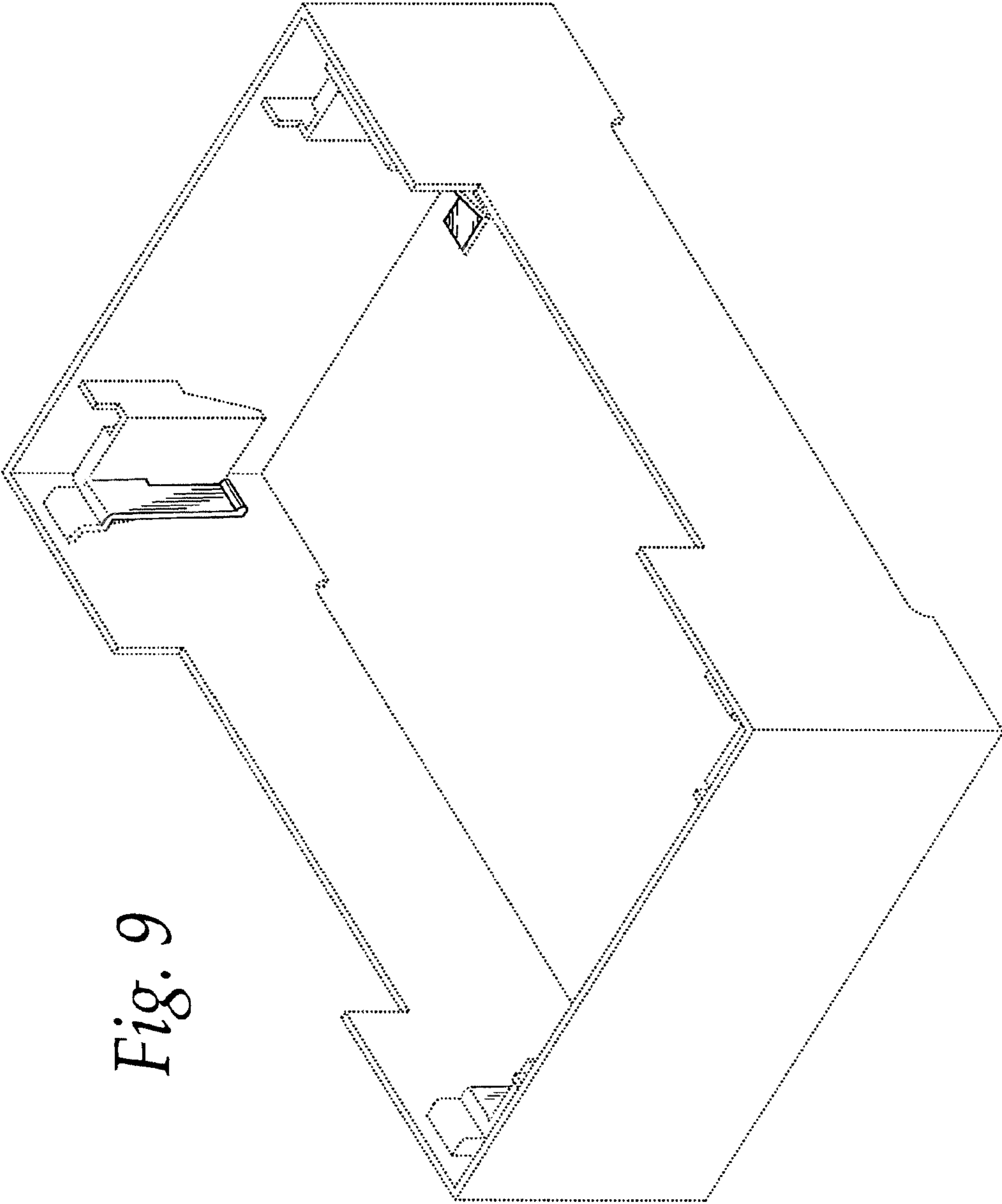

Fig. 9

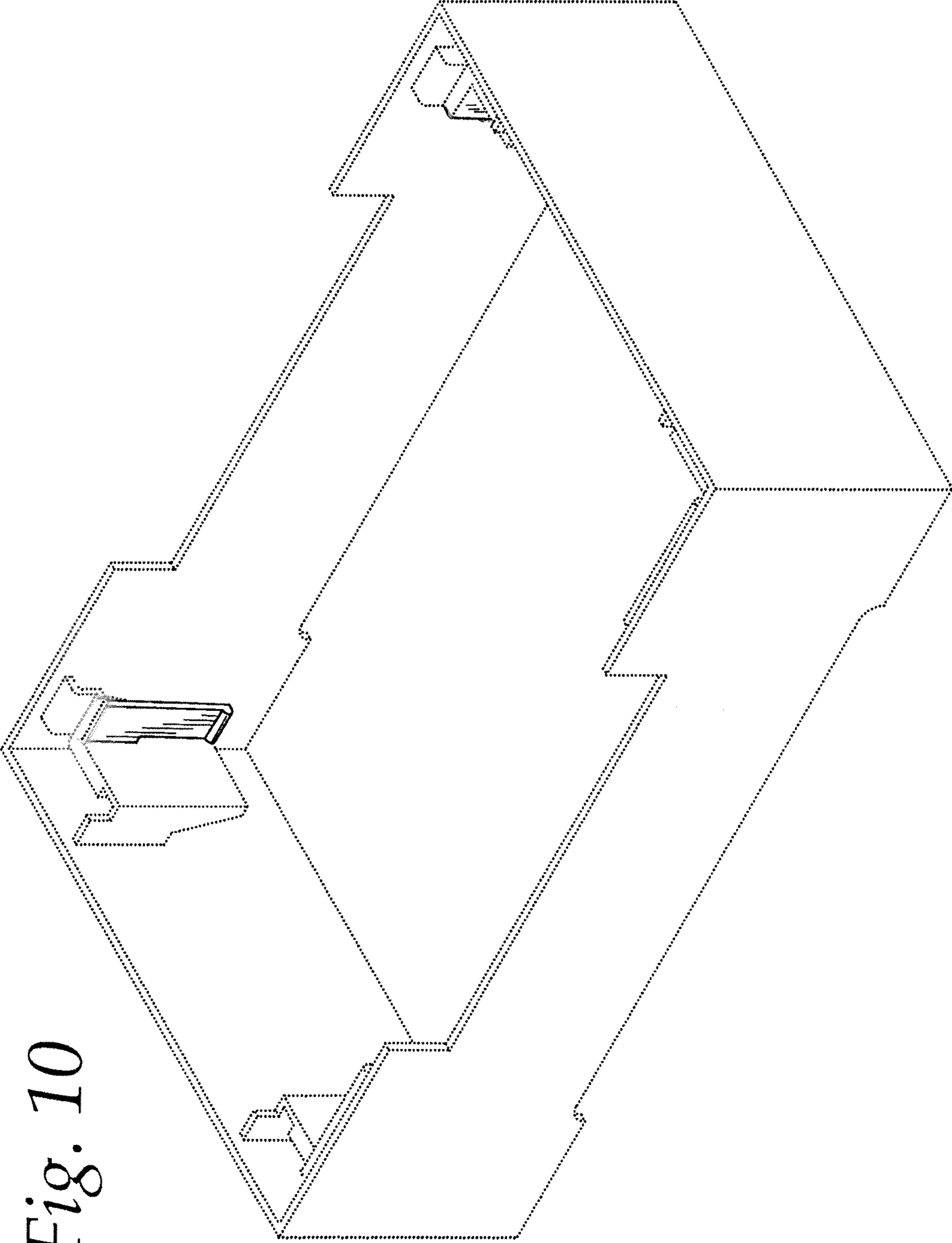

Fig. 10

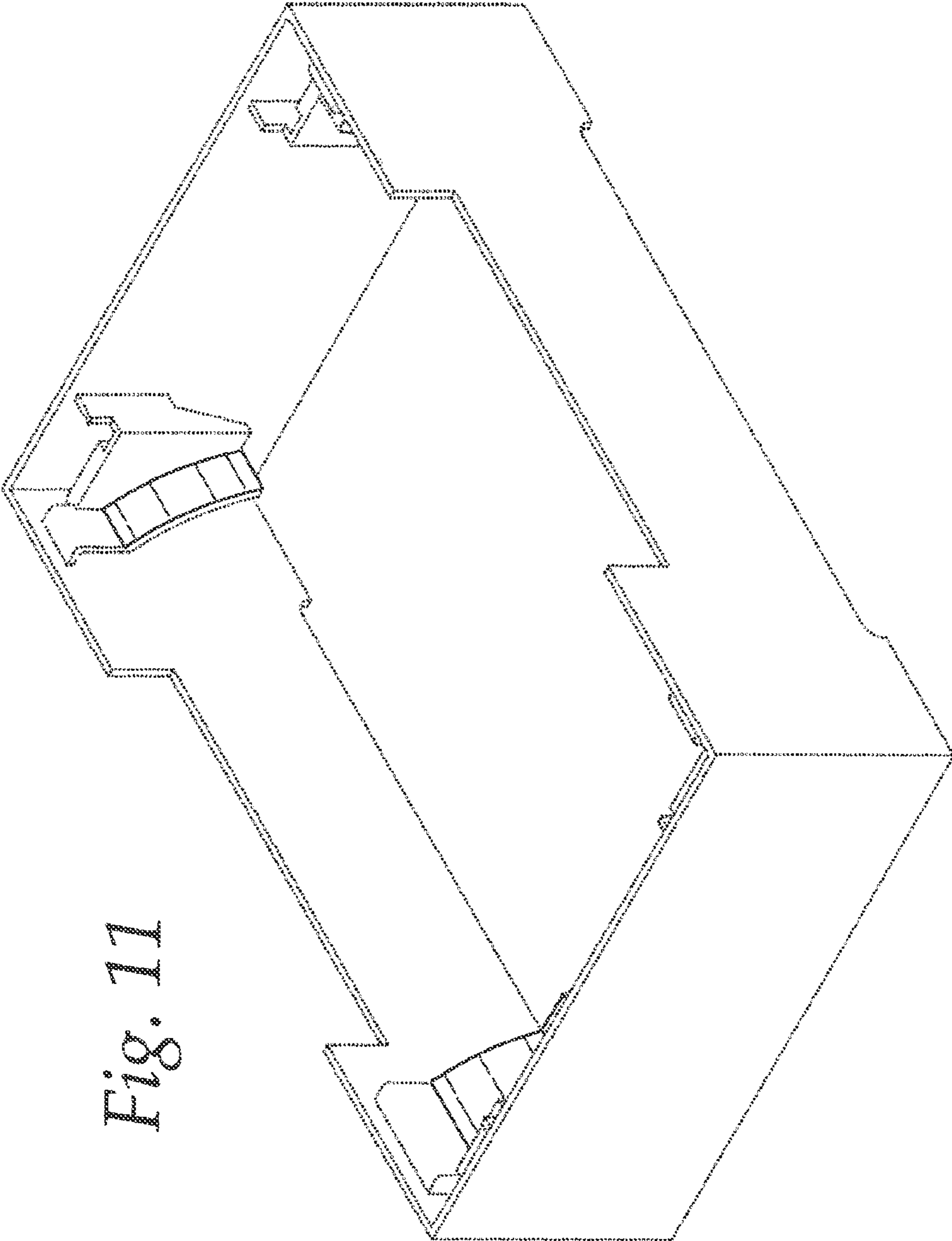
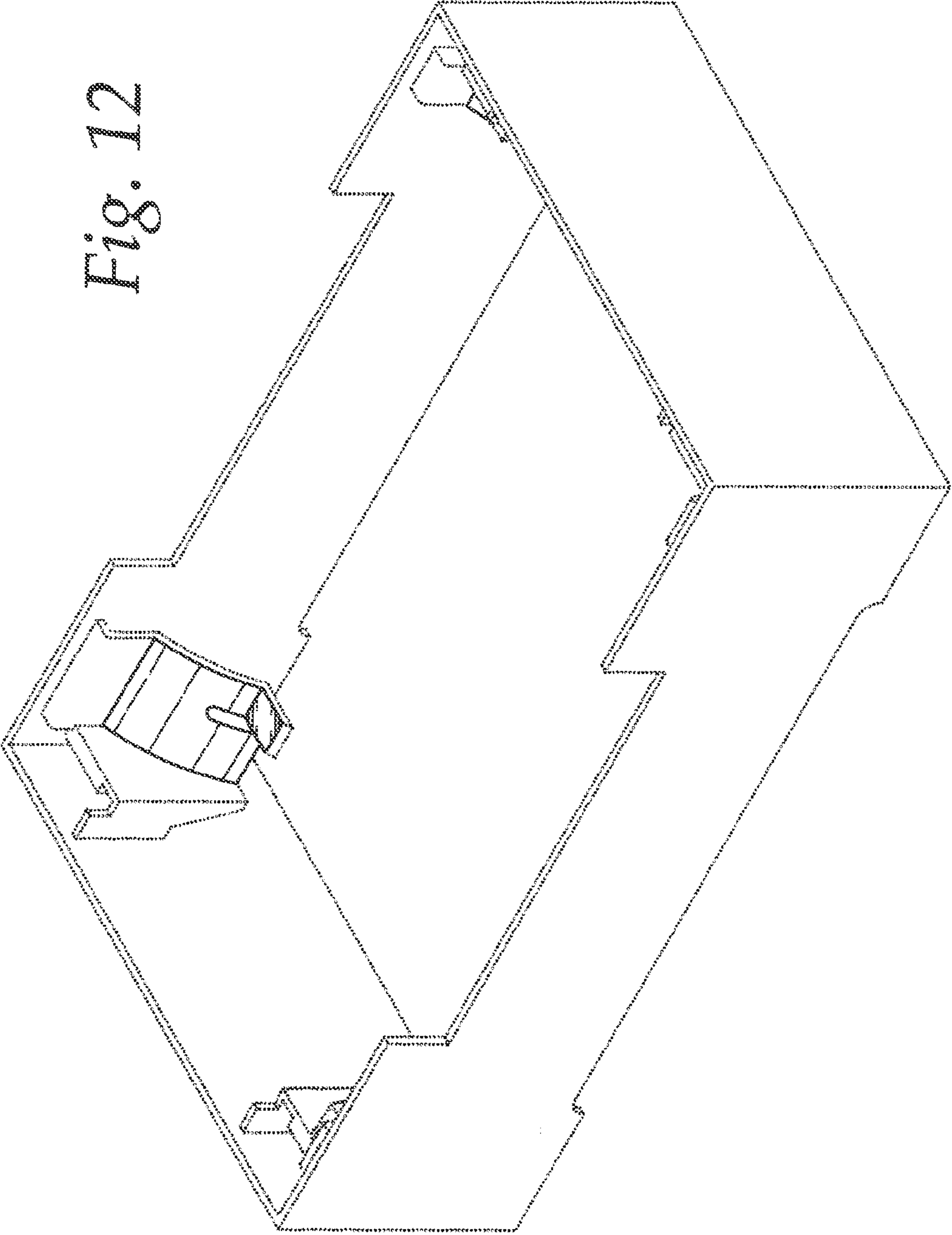

Fig. 11

Fig. 12



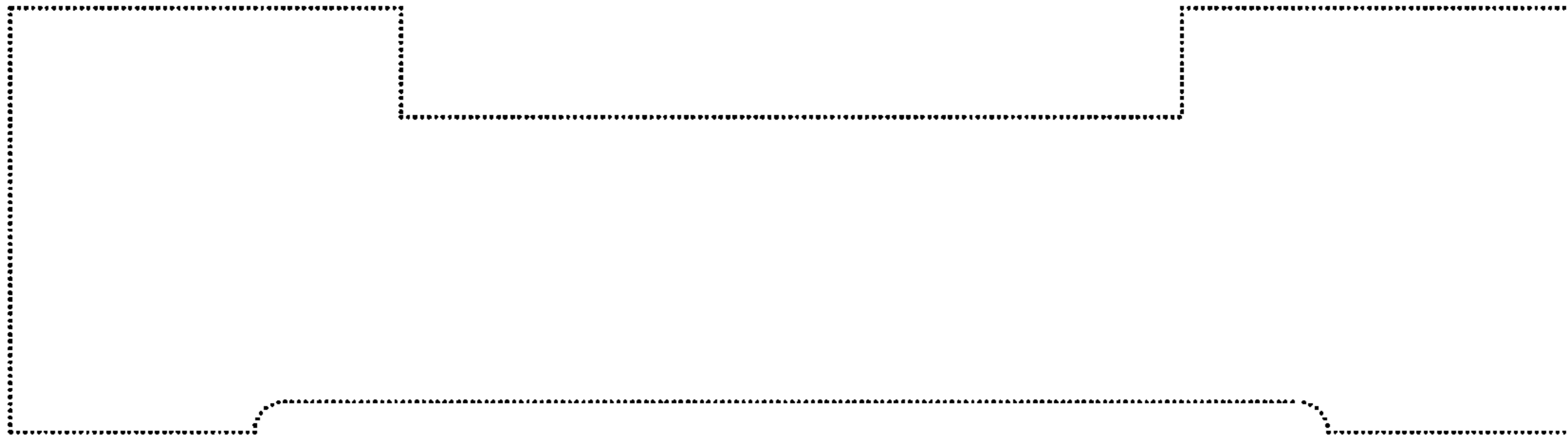

Fig. 13



Fig. 14

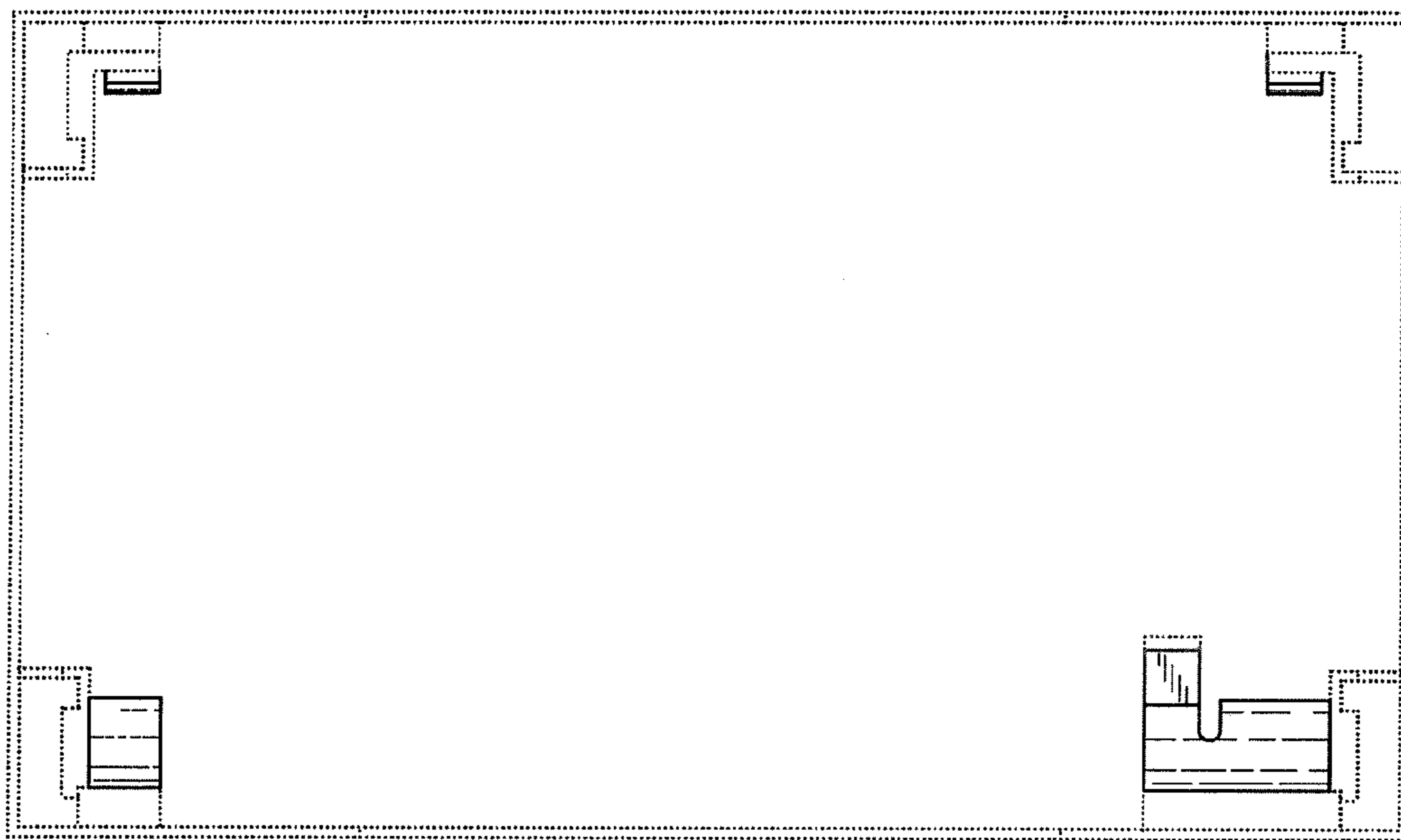

Fig. 15

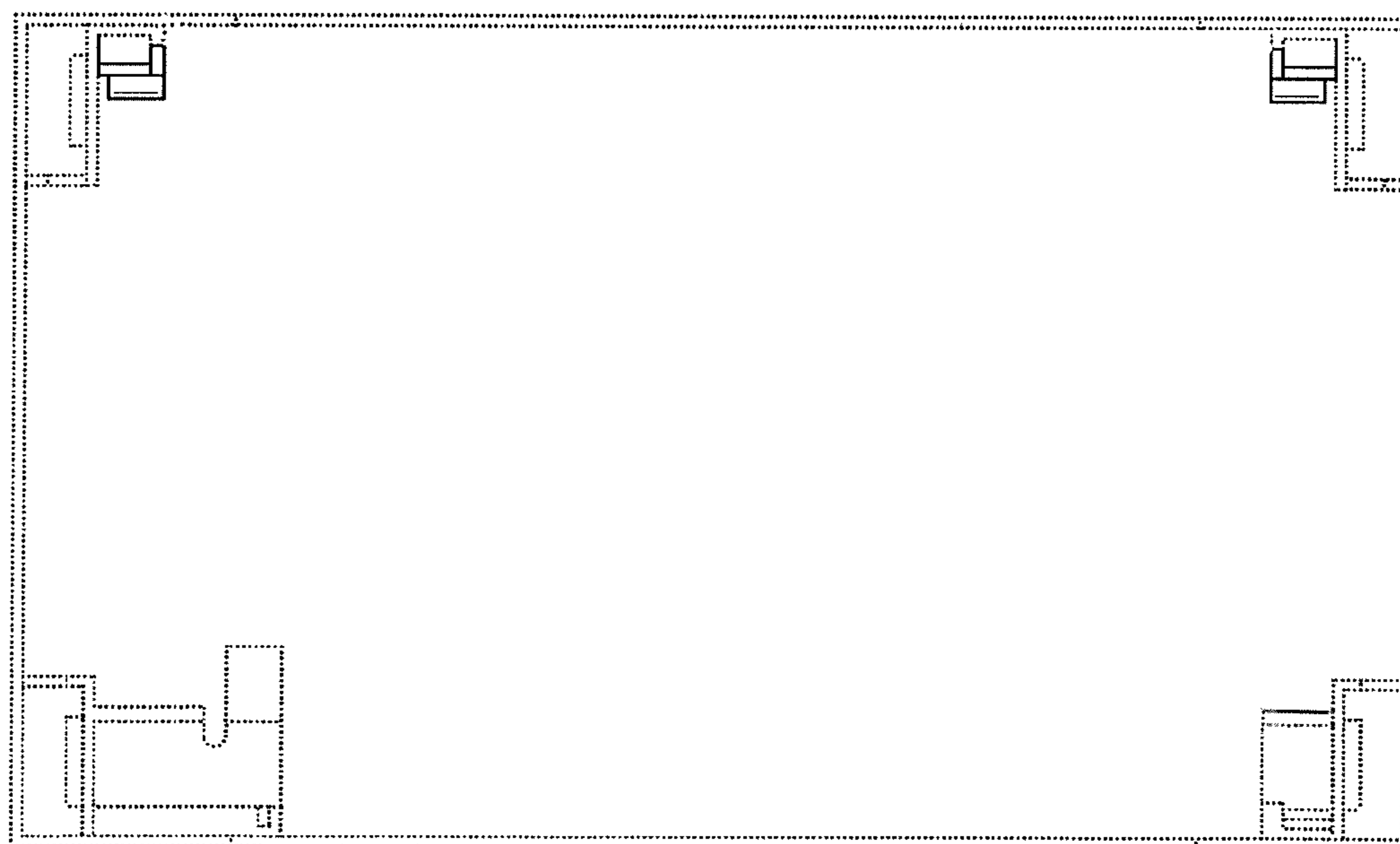

Fig. 16

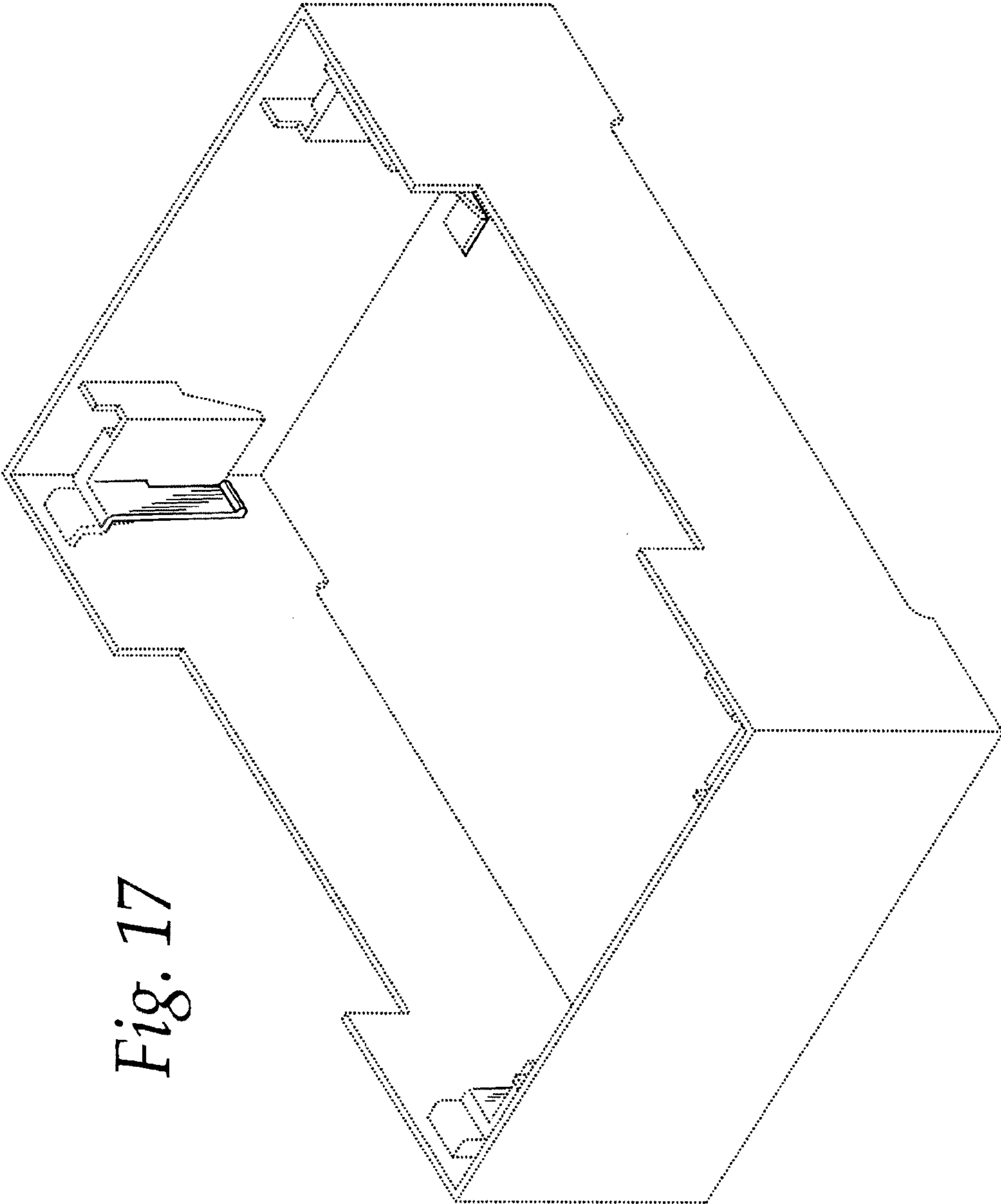

Fig. 17

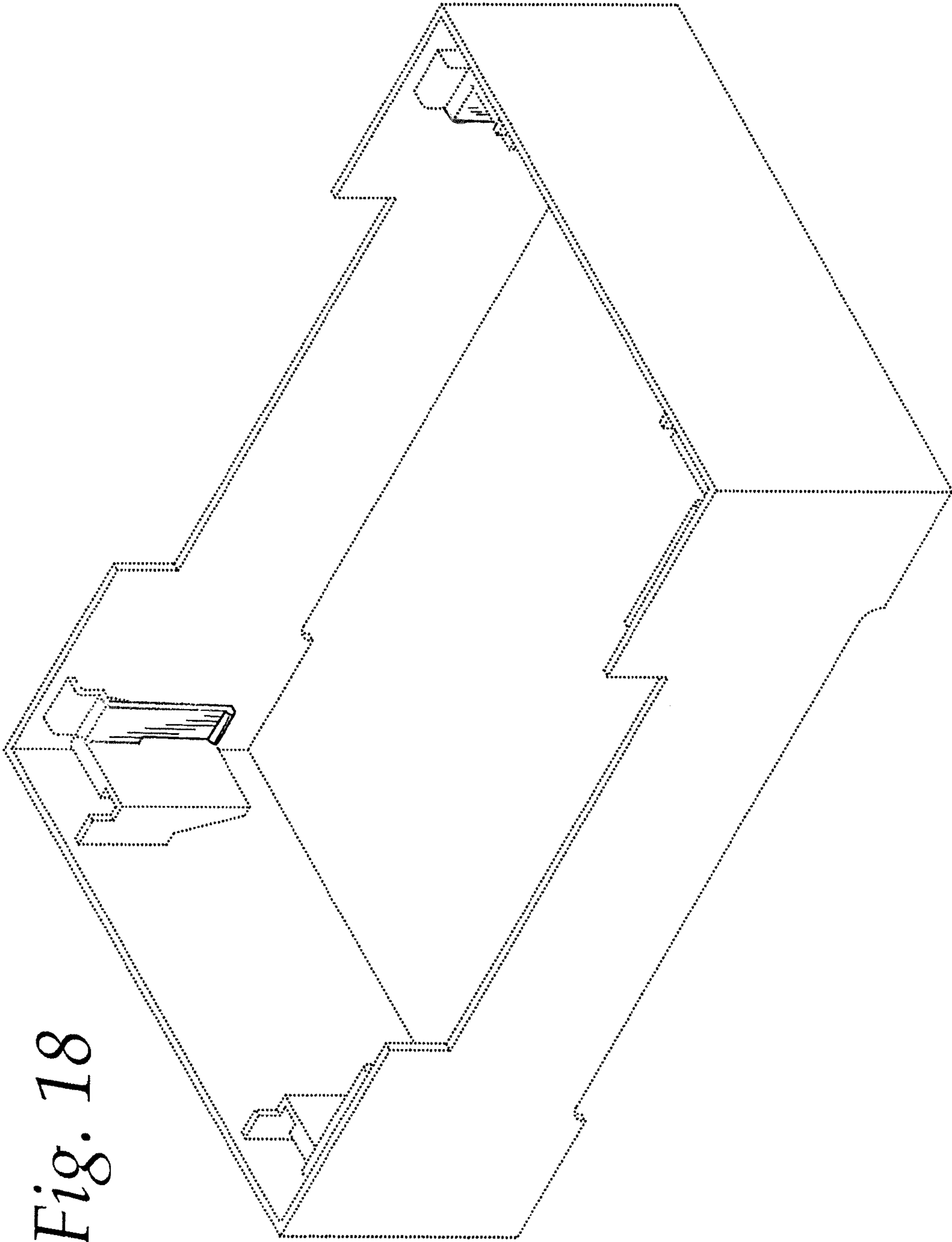

Fig. 18

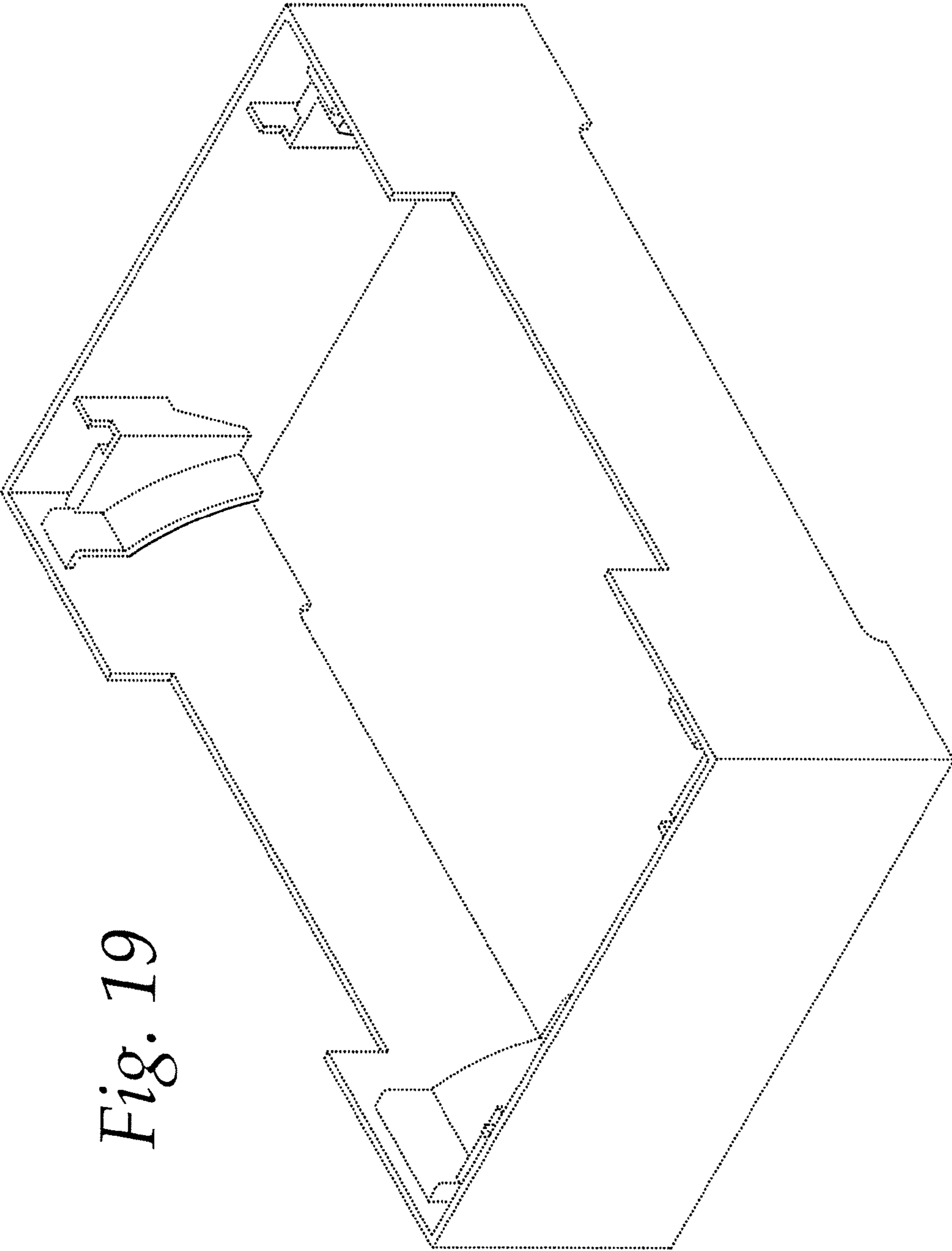
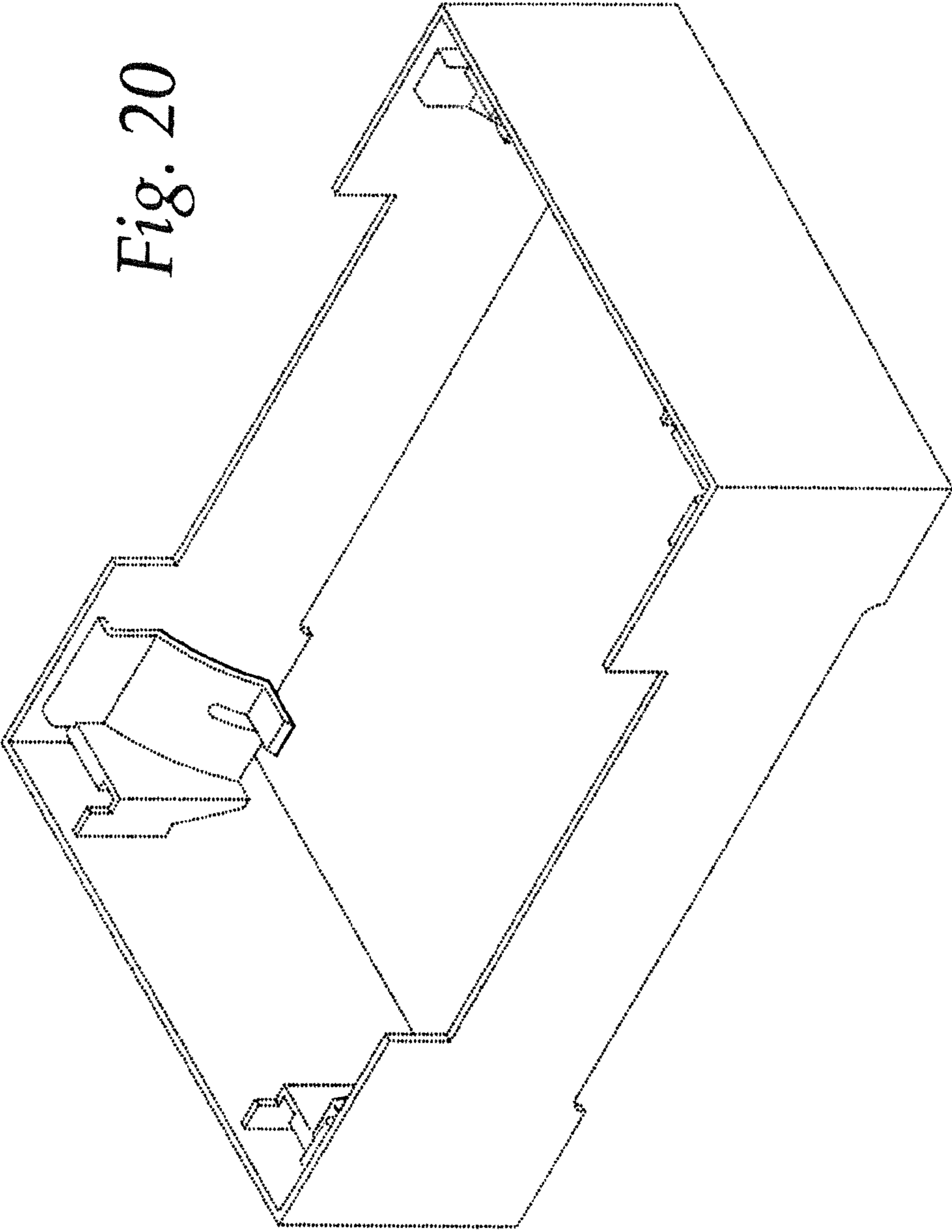

Fig. 19

Fig. 20



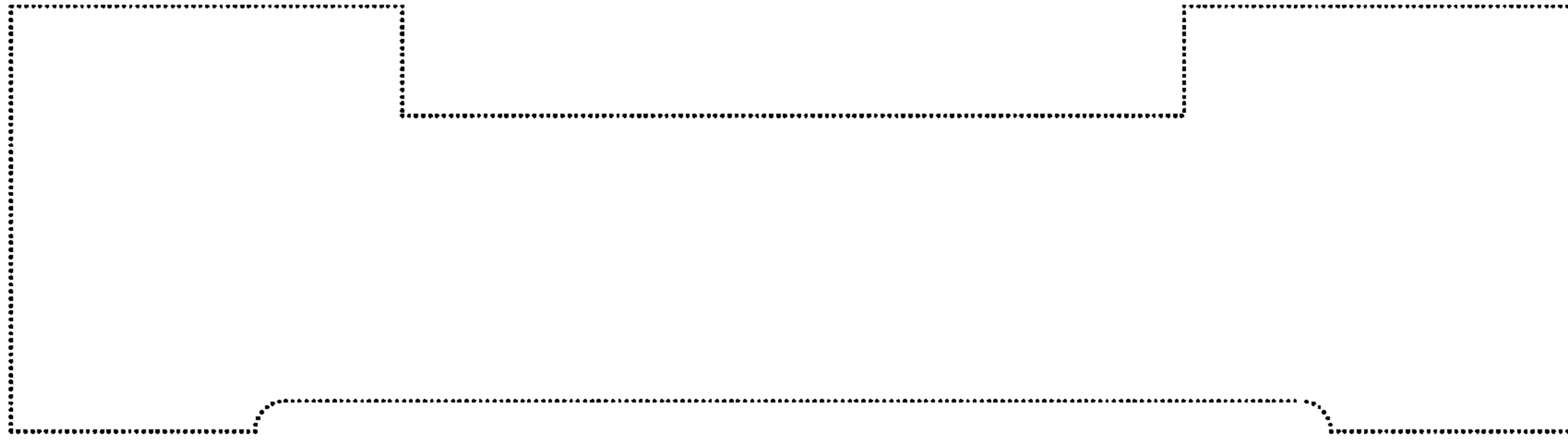

Fig. 21



Fig. 22

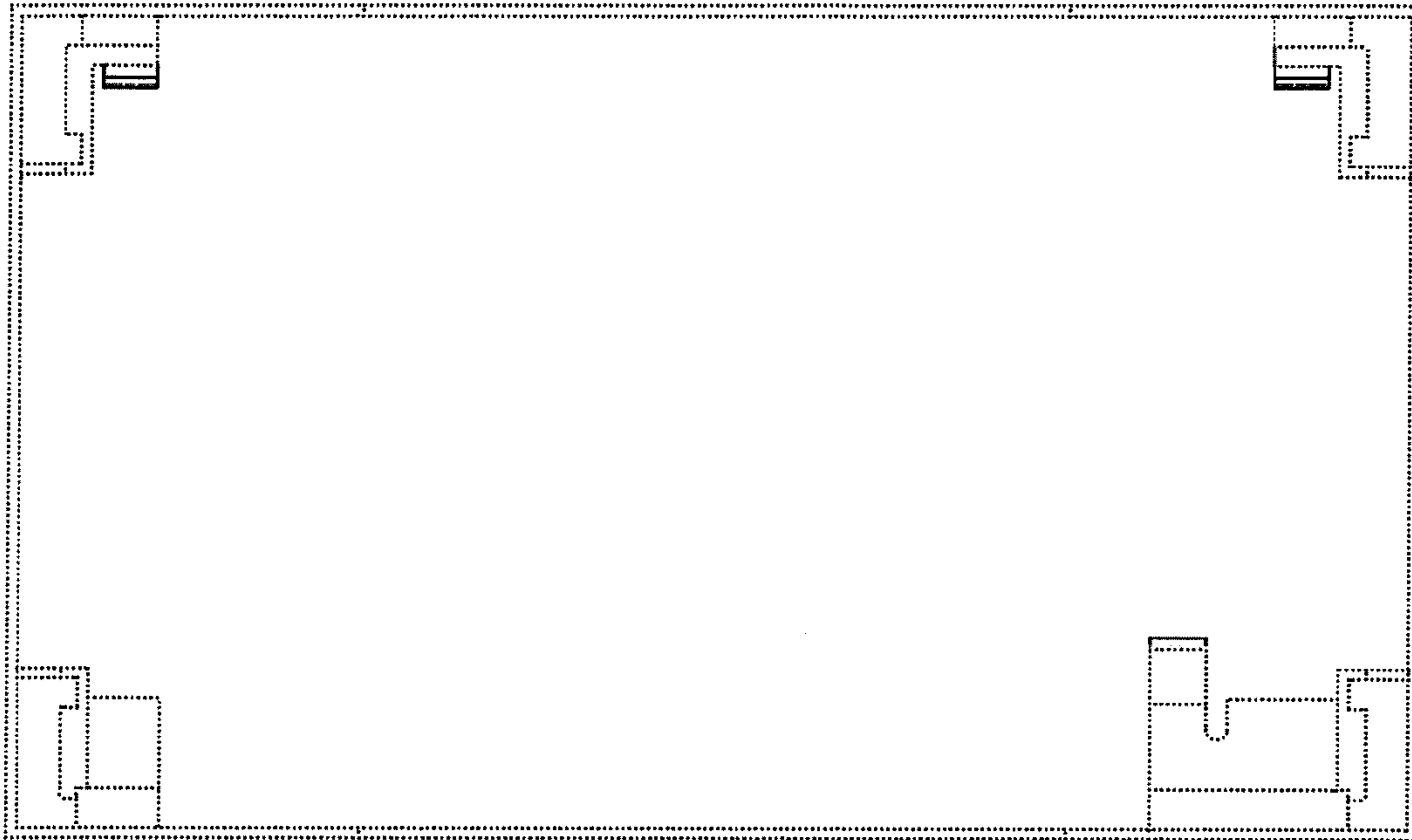

Fig. 23

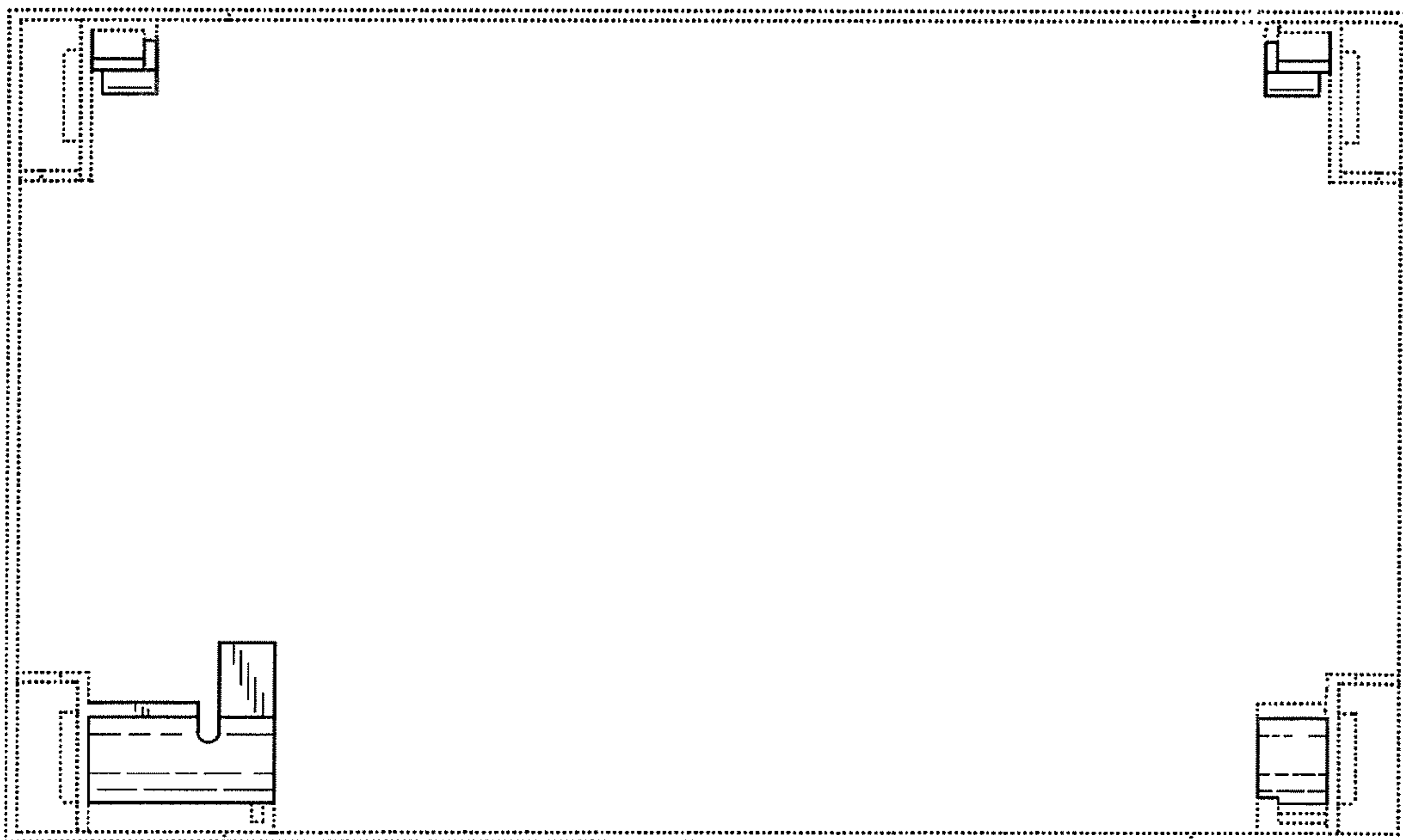

Fig. 24