



US00D690482S

(12) **United States Design Patent**
Bergman et al.

(10) **Patent No.:** **US D690,482 S**

(45) **Date of Patent:** **** Sep. 24, 2013**

(54) **PAINT APPLICATION CONTAINER**

(71) Applicant: **Bercom International, LLC**,
Chanhasen, MN (US)

(72) Inventors: **Christopher M. Bergman**, Hopkins,
MN (US); **Mark W. Bergman**,
Minnetonka, MN (US); **Jeffrey T.**
Given, St. Paul, MN (US); **Matthew V.**
Leyden, St. Paul, MN (US); **Jeffrey B.**
Waffensmith, North Oaks, MN (US)

(73) Assignee: **Bercom International, LLC**,
Chanhasen, MN (US)

(**) Term: **14 Years**

(21) Appl. No.: **29/445,954**

(22) Filed: **Feb. 19, 2013**

Related U.S. Application Data

(62) Division of application No. 29/409,474, filed on Dec.
23, 2011, now Pat. No. Des. 678,638.

(51) **LOC (9) Cl.** **07-07**

(52) **U.S. Cl.**
USPC **D32/54**

(58) **Field of Classification Search**
USPC D32/53-54; 220/495.01, 495.02,
220/570, 904; 15/260-264
See application file for complete search history.

(56) **References Cited**

U.S. PATENT DOCUMENTS

606,100 A	6/1898	Thompson
D33,891 S	1/1901	Kennedy
1,304,415 A	5/1919	Tucker
1,590,572 A	6/1926	Fredette
1,734,976 A	11/1929	McClellan
1,813,670 A	7/1931	Kessler
1,950,505 A	3/1934	Matters

2,314,835 A	12/1940	Johns et al.
2,228,536 A	1/1941	Scalph
2,626,737 A	1/1953	Pitz
2,661,858 A	12/1953	Howell
2,709,540 A	5/1955	Kenney

(Continued)

FOREIGN PATENT DOCUMENTS

GB	195523	4/1923
JP	10 287339	10/1998

OTHER PUBLICATIONS

Painters' Helpers Sporty's Tool Shop (1 page) bearing copyright
notice of 2001.

Fourteen (14) pages of photos of a pail known to the public prior to
Apr. 29, 2004.

Primary Examiner — Robin V Webster

(74) *Attorney, Agent, or Firm* — James L. Young; Westman,
Champlin & Kelly, P.A.

(57) **CLAIM**

The ornamental design for a paint application container, as
shown and described.

DESCRIPTION

FIG. 1 is of a perspective view of a paint application container
showing our design;

FIG. 2 is an end view thereof, as taken from the right end of
FIG. 1;

FIG. 3 is an end view thereof, as taken from the left end of
FIG. 1;

FIG. 4 is a right side view thereof;

FIG. 5 is a left side view thereof (the side views are mirror
images of one another);

FIG. 6 is a top view thereof; and,

FIG. 7 is a bottom view thereof.

The broken lines in the FIGS. 1-7 are for illustrative purposes
only and form no part of the claimed design in those embodi-
ments.

1 Claim, 5 Drawing Sheets

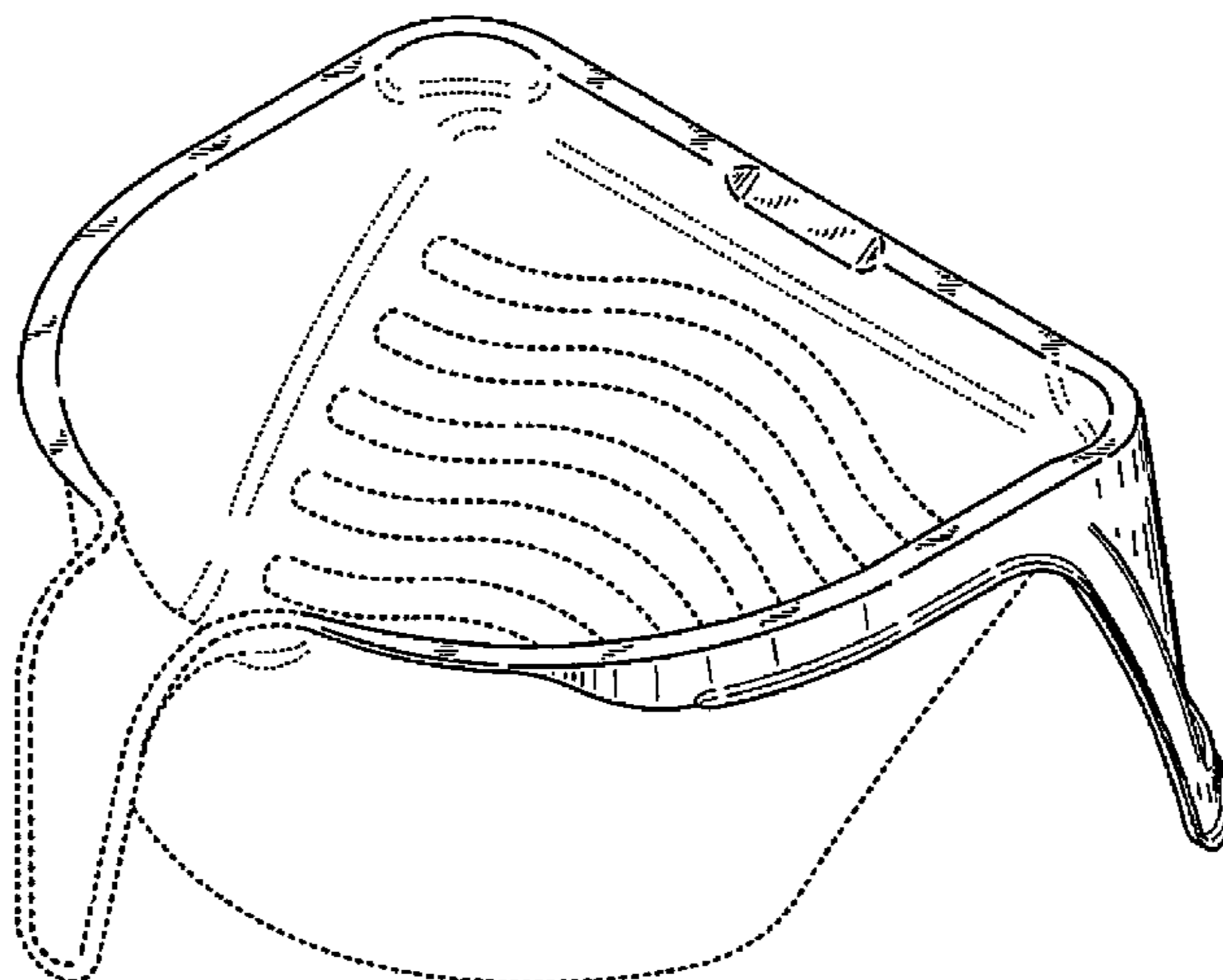

(56)

References Cited

U.S. PATENT DOCUMENTS							
2,712,668	A	7/1955	Thiele	5,511,279	A	4/1996	Ippolito
D175,865	S	10/1955	Stone	5,549,216	A	8/1996	Scholl
2,765,969	A	10/1956	Bennington	5,570,807	A	11/1996	Busch
2,963,003	A	2/1958	Oberg et al.	5,624,093	A	4/1997	Gemmell
D184,315	S	1/1959	Jennings et al.	5,641,087	A	6/1997	Moffitt
2,922,176	A	1/1960	Bernhardt	D390,596	S	2/1998	Domhoff et al.
3,014,616	A	12/1961	Kavanaugh et al.	5,746,346	A	5/1998	Crilly
3,014,621	A	12/1961	Povitz	D395,531	S	6/1998	Mandell et al.
D193,382	S	8/1962	Goetz	D397,833	S	9/1998	Zurawin
3,138,280	A	6/1964	Shafer	5,810,196	A	9/1998	Lundy
3,139,646	A	7/1964	Vernon	RE35,933	E	10/1998	Scholl
3,157,902	A	11/1964	Hardwick	D401,116	S	11/1998	Demore
D202,134	S	8/1965	Bryan	5,836,469	A	11/1998	Zebrowski
3,219,233	A	11/1965	Whiteford	5,899,354	A	5/1999	Garcia
3,229,820	A	1/1966	Hentzi et al.	D415,864	S	10/1999	Axhamre
3,292,815	A	12/1966	Smith	5,971,201	A	10/1999	Daw
3,311,252	A	3/1967	Swartwood et al.	6,019,241	A	2/2000	Burns
3,341,876	A	9/1967	Campbell	D422,450	S	4/2000	Conti
D208,969	S	10/1967	Paxton	D423,729	S	4/2000	Morgan
3,351,970	A	11/1967	Engh	6,065,633	A	5/2000	Abbey
D211,611	S	7/1968	Fox, Jr. et al.	6,119,303	A	9/2000	Passafiume
D212,831	S	11/1968	Koch	6,138,963	A	10/2000	Malvasio
3,425,012	A	1/1969	Gottinger	D435,728	S	1/2001	Miles et al.
D216,277	S	12/1969	James	D444,604	S	7/2001	Hoffert et al.
3,536,285	A	10/1970	Vaughn	D444,929	S	7/2001	Cox
3,590,416	A	7/1971	Henningsen	6,260,730	B1	7/2001	Fellman
3,595,431	A	7/1971	Bird	6,276,554	B1	8/2001	Lallement et al.
3,602,939	A	9/1971	Schoenholz	D452,130	S	12/2001	Richardson
D223,864	S	6/1972	Vines	D453,243	S	1/2002	Burke
3,682,352	A	8/1972	Doucette	D458,723	S	6/2002	Malvasio
3,707,242	A	12/1972	Golden	D460,845	S	7/2002	Bergman
3,729,158	A	4/1973	Nagy	6,419,106	B1	7/2002	Bebak
3,828,389	A	8/1974	Heisler	D462,902	S	9/2002	Gittins et al.
3,837,034	A	9/1974	Leffert	6,449,829	B1	9/2002	Malvasio et al.
3,940,824	A	3/1976	Gioia et al.	D466,407	S	12/2002	Nance
3,947,135	A	3/1976	Hawk	D466,787	S	12/2002	Clancy
4,023,702	A	5/1977	McKnight	D467,784	S	12/2002	Maier
4,061,242	A	12/1977	Donlon	D469,233	S	1/2003	Begnani
4,101,046	A	7/1978	Puntillo	6,622,340	B2	9/2003	Rosa
4,145,789	A	3/1979	Morgan, Sr.	D482,274	S	11/2003	Walsh et al.
4,164,299	A	8/1979	Fuhr	D482,830	S	11/2003	Kohn
D254,482	S	3/1980	Bell	D483,917	S	12/2003	Frantz
D270,961	S	10/1983	Hawkins et al.	6,708,838	B2	3/2004	Bergman et al.
4,445,250	A	5/1984	Seidl	D492,196	S	6/2004	Hyhlik et al.
D277,080	S	1/1985	Gagnon	D493,035	S	7/2004	Bergman
4,519,565	A	5/1985	Whitmore	6,802,431	B2	10/2004	Schinkel
4,627,546	A	12/1986	Carranza	D499,027	S	11/2004	Walsh et al.
D289,452	S	4/1987	Fuller	D509,420	S	9/2005	Hauber
D291,612	S	8/1987	Inui	6,991,829	B2	1/2006	Bergman
4,691,840	A	9/1987	Ferbrache	D518,263	S	3/2006	Verhaar
4,798,307	A	1/1989	Evrard	D524,501	S	7/2006	Prokop et al.
D301,785	S	6/1989	Goetz	D526,748	S	8/2006	Van Skiver
D302,614	S	8/1989	Beatty	7,083,044	B1	8/2006	Kilian et al.
4,860,891	A	8/1989	Biggio	D528,706	S	9/2006	Jefferson
D305,467	S	1/1990	Dagge	D535,794	S	1/2007	Lundy et al.
4,895,269	A	1/1990	Cade	7,191,913	B2	3/2007	Byrne
4,927,046	A	5/1990	Armstrong	D546,160	S	7/2007	Reithmeyer
4,928,873	A	5/1990	Johnson	D546,514	S	7/2007	Byrne
5,011,536	A	4/1991	Boom	D548,913	S	8/2007	Van Landingham
5,033,704	A	7/1991	Kerr	D549,913	S	8/2007	Bergman
5,083,733	A	1/1992	Marino et al.	D553,818	S	10/2007	Moon
5,092,481	A	3/1992	Skelton	D562,518	S	2/2008	Lundy
5,147,067	A	9/1992	Effertz	D569,567	S	5/2008	Kohn
5,169,025	A	12/1992	Guo	D571,969	S	6/2008	Byers
5,201,439	A	4/1993	Davies	D578,874	S	10/2008	Smith et al.
5,207,348	A	5/1993	Fischer et al.	D581,118	S	11/2008	Bergman
5,222,656	A	6/1993	Carlson	D586,056	S	2/2009	Shea
5,320,249	A	6/1994	Strech	D594,163	S	6/2009	Sparano
5,341,969	A	8/1994	Accardo et al.	D607,624	S	1/2010	Bergman
D350,632	S	9/1994	Cummins	D612,119	S	3/2010	Bergman
D353,241	S	12/1994	Breen	D617,517	S	6/2010	Bergman
D353,697	S	12/1994	Breen et al.	D645,627	S	9/2011	Arvinte et al.
5,400,916	A	3/1995	Weber	2002/0005409	A1	1/2002	Rose
5,429,262	A	7/1995	Sharkey	2002/0036206	A1	3/2002	Bergman et al.
5,493,751	A	2/1996	Misiukowicz et al.	2002/0056714	A1	5/2002	Schinkel
				2004/0118861	A1	6/2004	Bergman et al.
				2004/0134917	A1	7/2004	Carnegie
				2004/0173622	A1	9/2004	Findleton
				2004/0195248	A1	10/2004	Garcia

US D690,482 S

Page 3

2004/0206761	A1	10/2004	Frantz	2006/0219720	A1	10/2006	Lundy et al.
2004/0208083	A1	10/2004	Armendariz et al.	2006/0225959	A1	10/2006	Pohl
2004/0256335	A1	12/2004	Sholem	2006/0226154	A1	10/2006	Lundy et al.
2006/0124649	A1	6/2006	Campbell	2006/0243732	A1	11/2006	Bergman

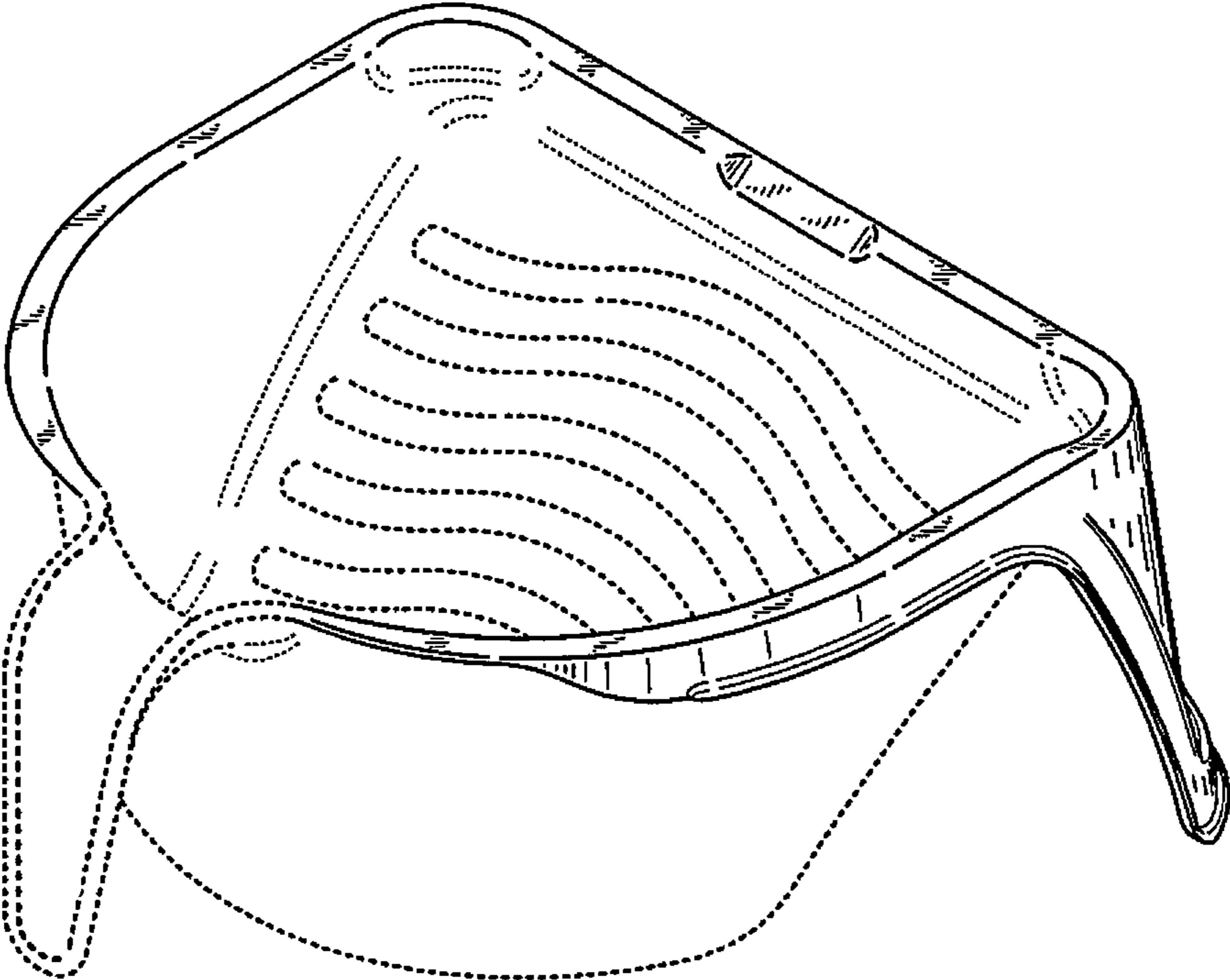

FIG. 1

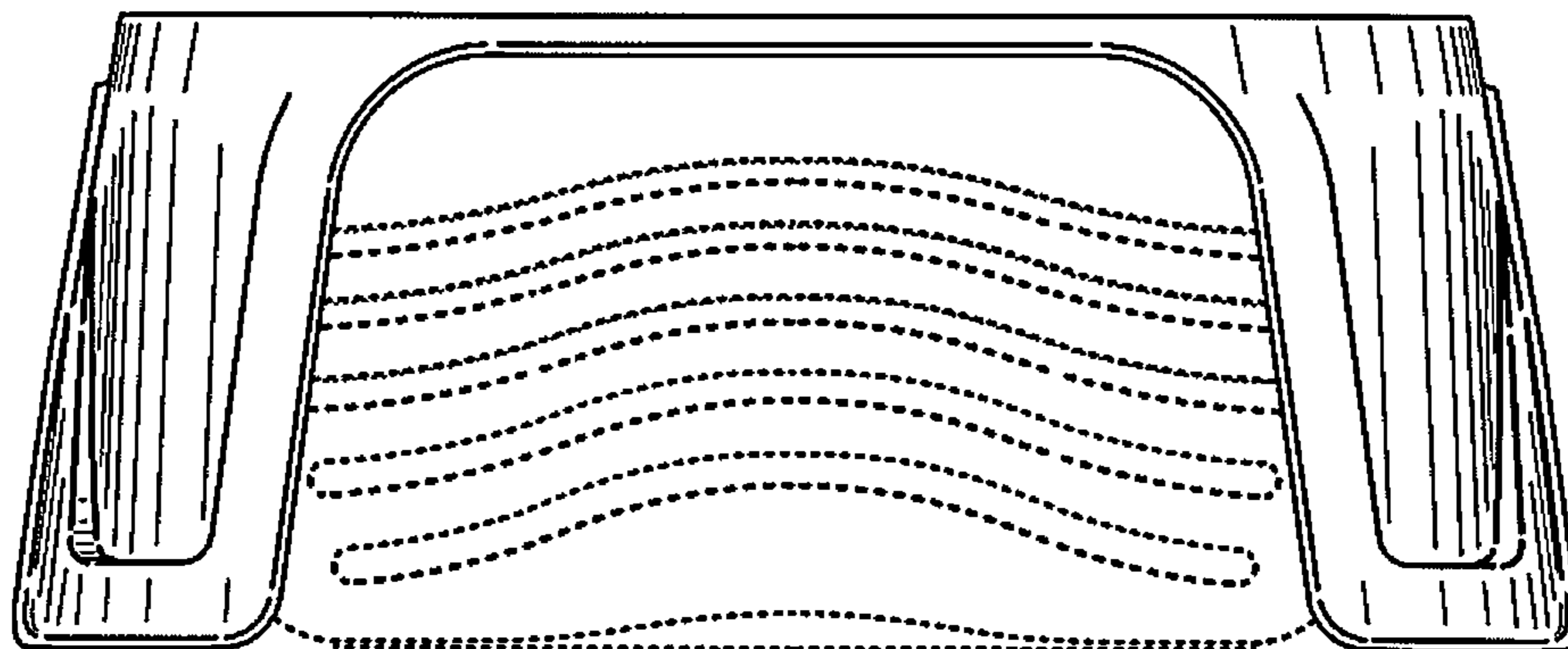

FIG. 2

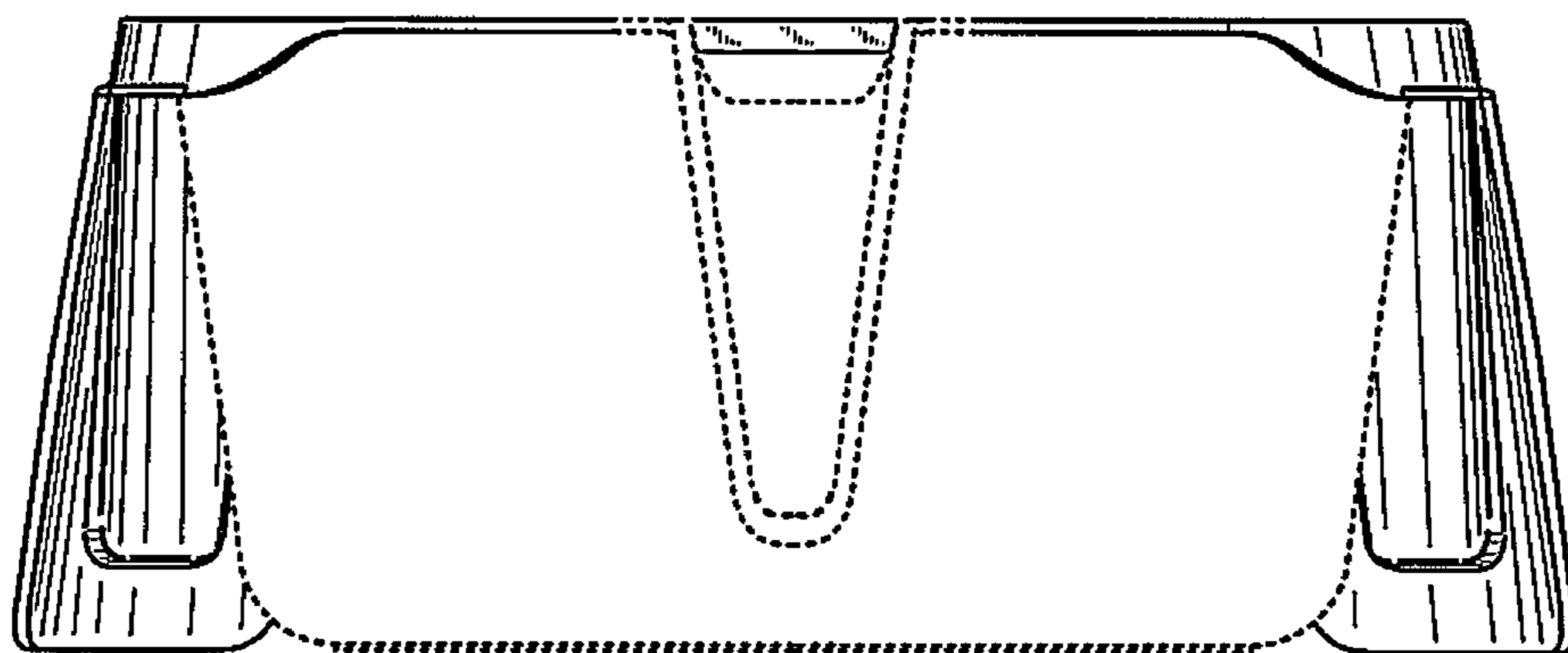

FIG. 3

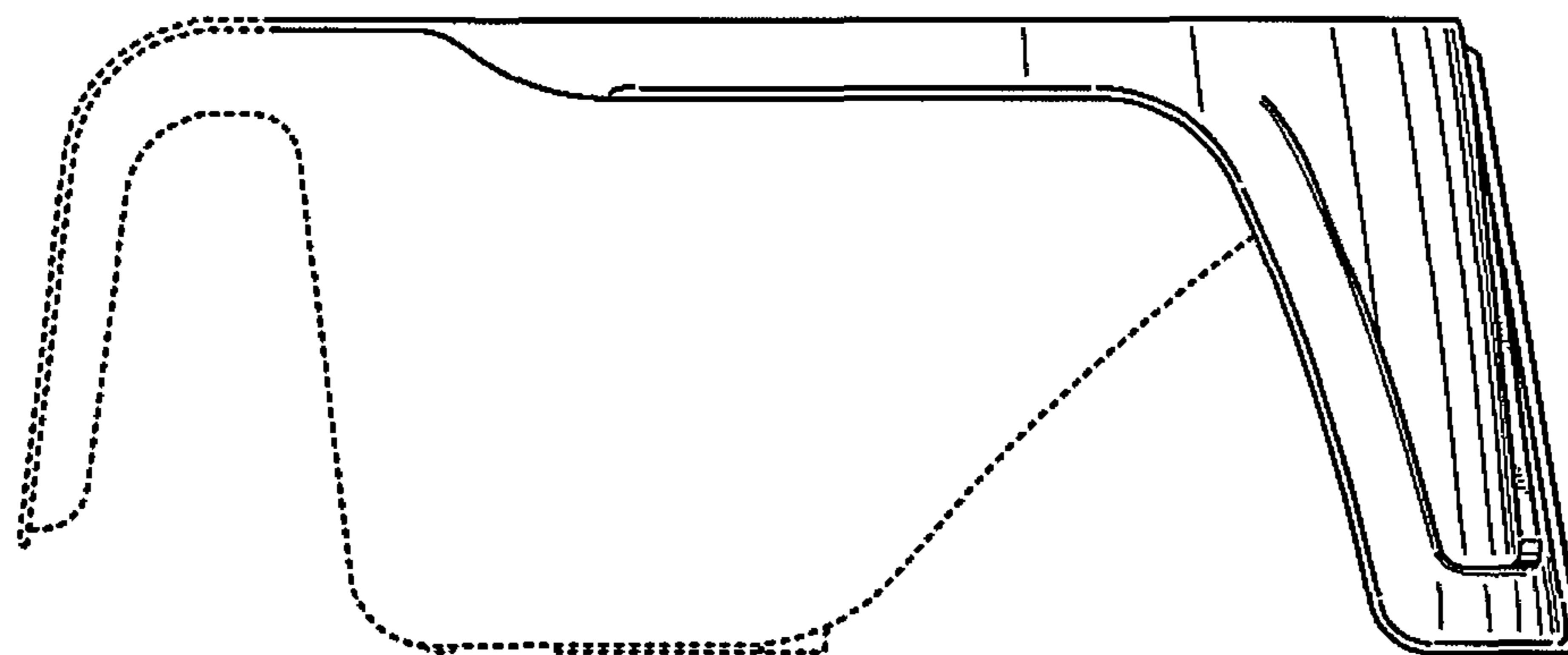

FIG. 4

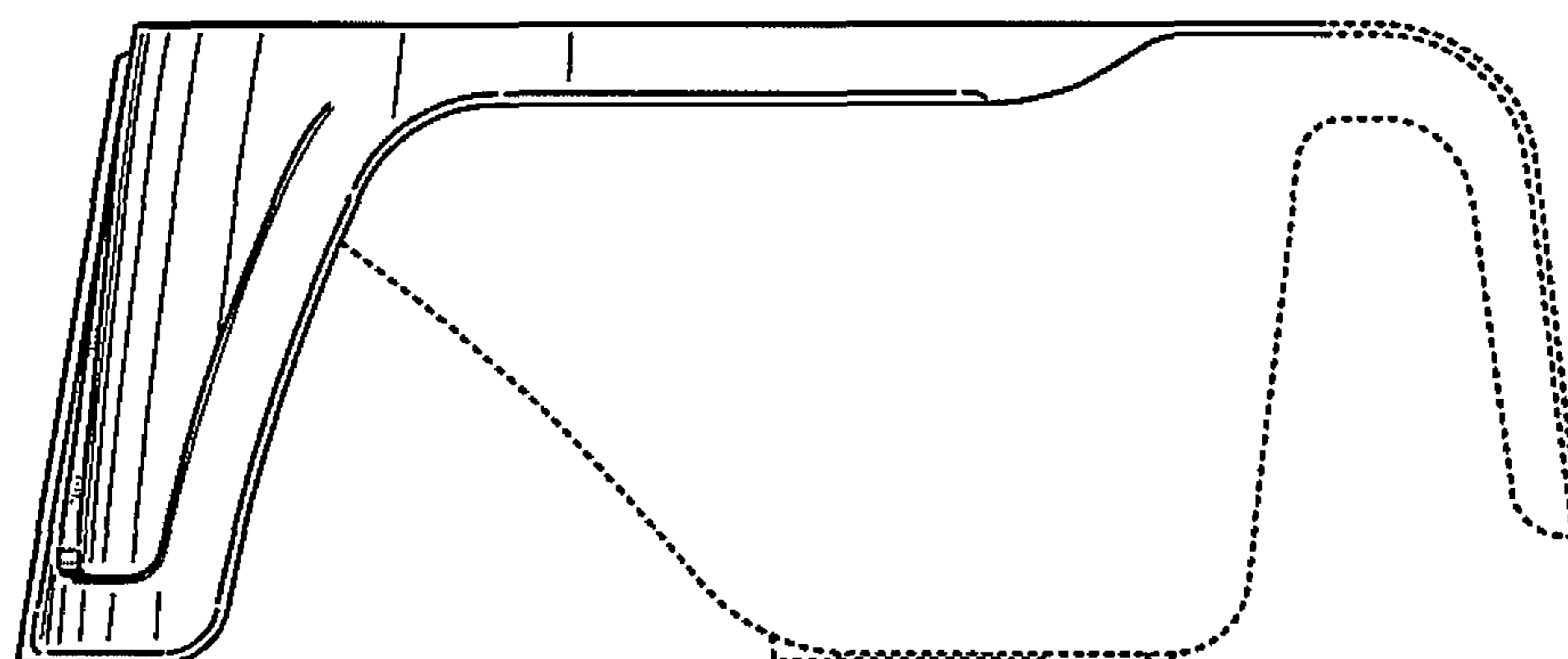

FIG. 5

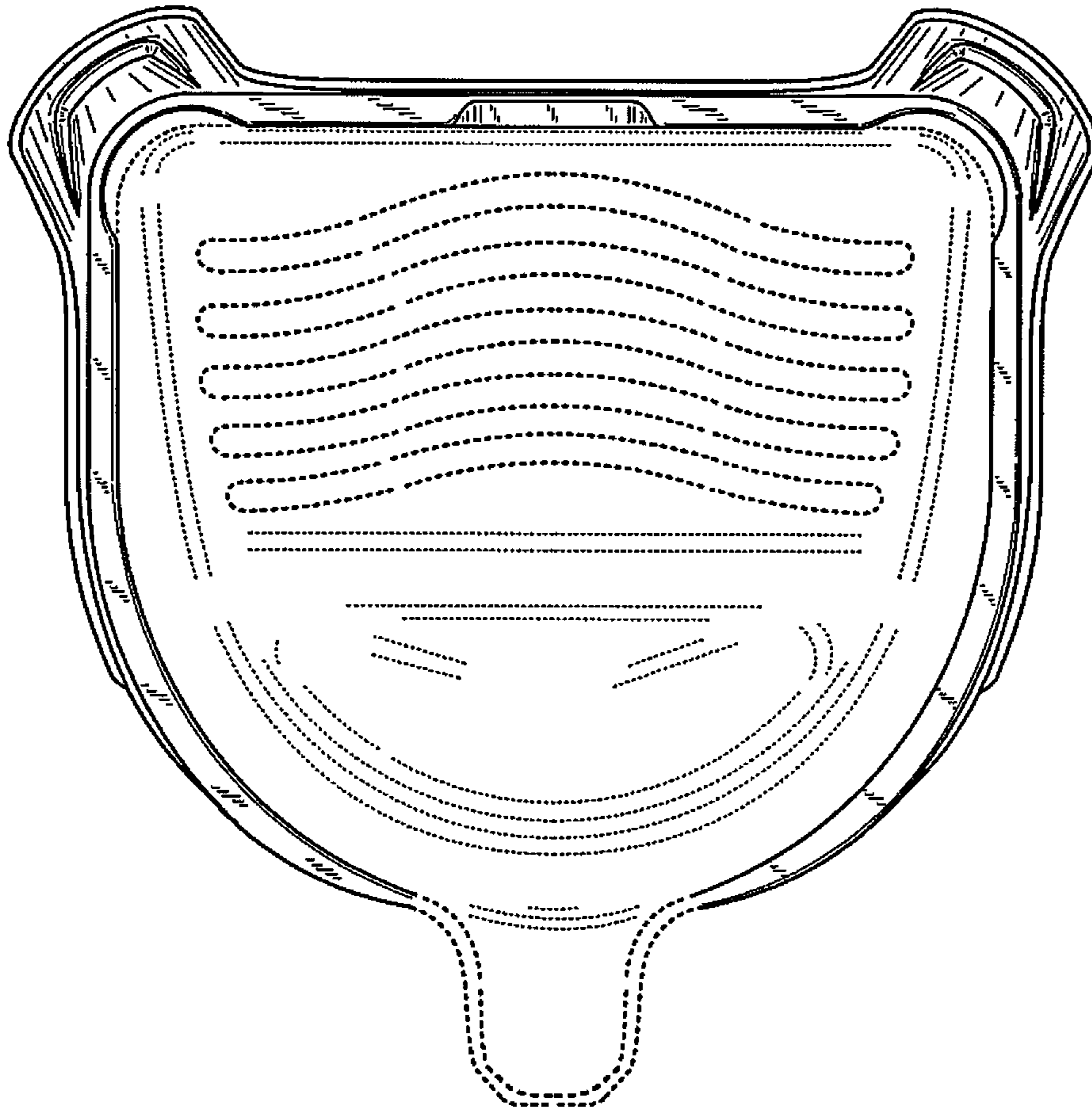

FIG. 6

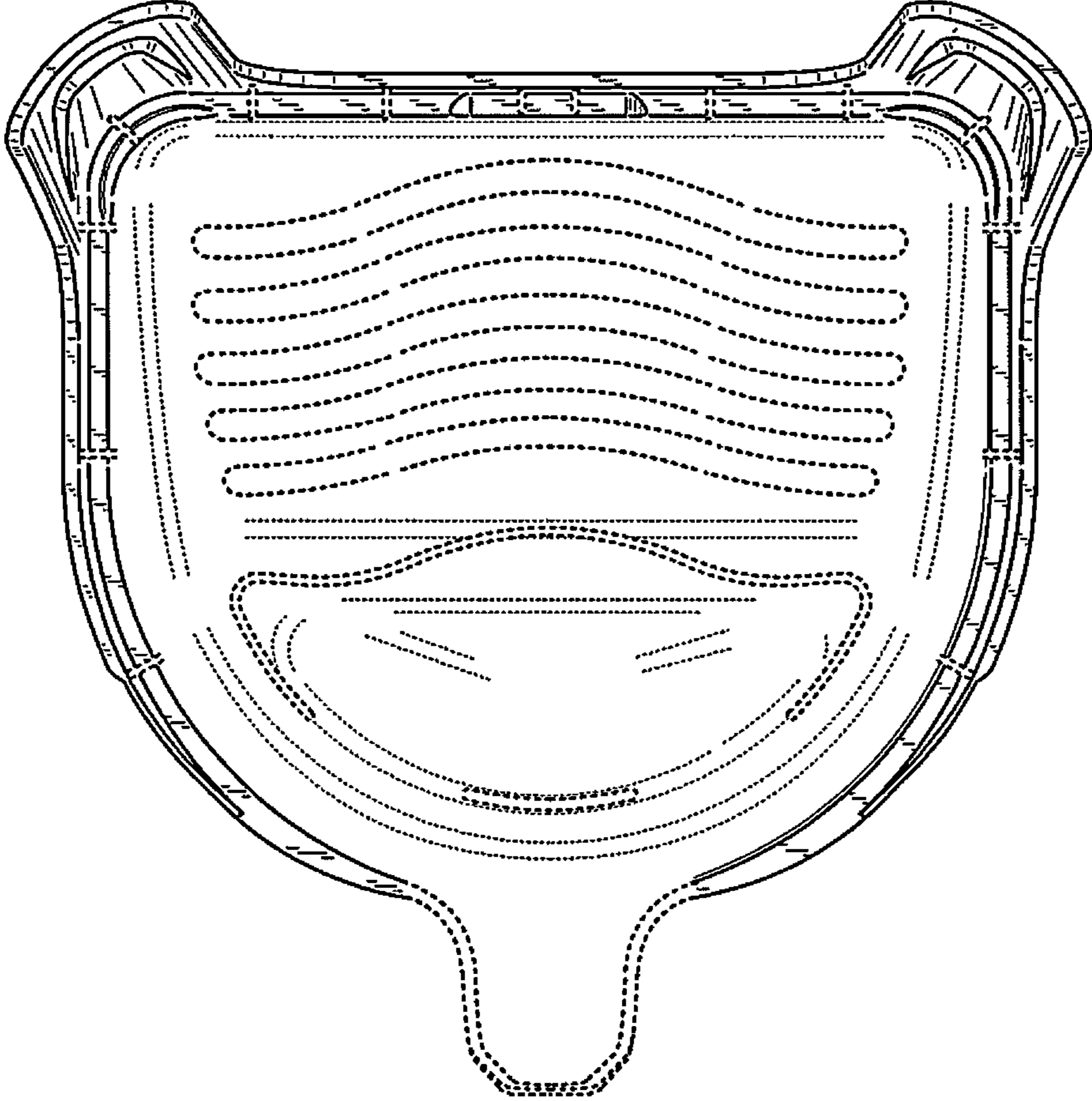

FIG. 7