



US00D690417S

(12) **United States Design Patent**
Solomon

(10) **Patent No.:** **US D690,417 S**

(45) **Date of Patent:** **** Sep. 24, 2013**

(54) **DISPOSABLE SYRINGE WITH UNIT MARKINGS FOR THE DOSAGE AND ADMINISTRATION OF REFINED FORMS OF BOTULINUM TOXIN A**

(71) Applicant: **Sid Solomon**, Los Angeles, CA (US)

(72) Inventor: **Sid Solomon**, Los Angeles, CA (US)

(**) Term: **14 Years**

(21) Appl. No.: **29/435,177**

(22) Filed: **Oct. 19, 2012**

(51) **LOC (9) Cl.** **24-02**

(52) **U.S. Cl.**
USPC **D24/114**

(58) **Field of Classification Search**
USPC D24/112-114, 133, 186, 104, 130,
D24/127; 606/181, 185; 604/264, 272, 115,
604/232, 187, 158, 164.08, 192, 263, 163,
604/181, 184, 198, 227
See application file for complete search history.

(56) **References Cited**

U.S. PATENT DOCUMENTS

D188,927	S	9/1960	Burke	
2,972,991	A	2/1961	Burke	
3,216,616	A	11/1965	Blankenship, Jr.	
3,320,954	A	5/1967	Cowley	
3,391,694	A	7/1968	Spaeth	
D252,586	S	8/1979	Kovach	
D258,454	S *	3/1981	Echevarria et al.	D19/46
5,294,325	A *	3/1994	Liu	604/190
5,651,774	A *	7/1997	Taranto et al.	604/263
D436,661	S *	1/2001	Berry	D24/114

6,432,087	B1 *	8/2002	Hoeck et al.	604/198
6,936,034	B2 *	8/2005	Watkins	604/197
D545,429	S *	6/2007	Hays	D24/114
D552,773	S *	10/2007	Greenberg	D24/130
D557,337	S *	12/2007	Isaacs	D24/114
D597,204	S *	7/2009	Oberlaender et al.	D24/133
7,582,073	B2 *	9/2009	Barrelle et al.	604/192
D626,216	S	10/2010	Tyce	
7,938,800	B2 *	5/2011	Koh	604/198
D657,867	S *	4/2012	Effenberger	D24/114
2008/0114305	A1	5/2008	Gerondale	
2010/0130961	A1	5/2010	Tucker	

* cited by examiner

Primary Examiner — David Muller

(74) *Attorney, Agent, or Firm* — QuickPatents; Kevin Prince

(57) **CLAIM**

I claim the ornamental design for a disposable syringe with unit markings for the dosage and administration of refined forms of botulinum toxin A, as shown and described.

DESCRIPTION

FIG. 1 is a perspective view of a disposable syringe with unit markings for the dosage and administration of refined forms of botulinum toxin A, showing my new design;

FIG. 2 is a top plan view thereof;

FIG. 3 is a bottom plan view thereof;

FIG. 4 is a left-side elevational view thereof, the right-side elevational view being a mirror image thereof;

FIG. 5 is a front elevational view thereof; and,

FIG. 6 is a rear elevational view thereof.

The broken lines showing a logo in FIGS. 1 and 2 depict environmental matter and form no part of the claimed design.

1 Claim, 3 Drawing Sheets

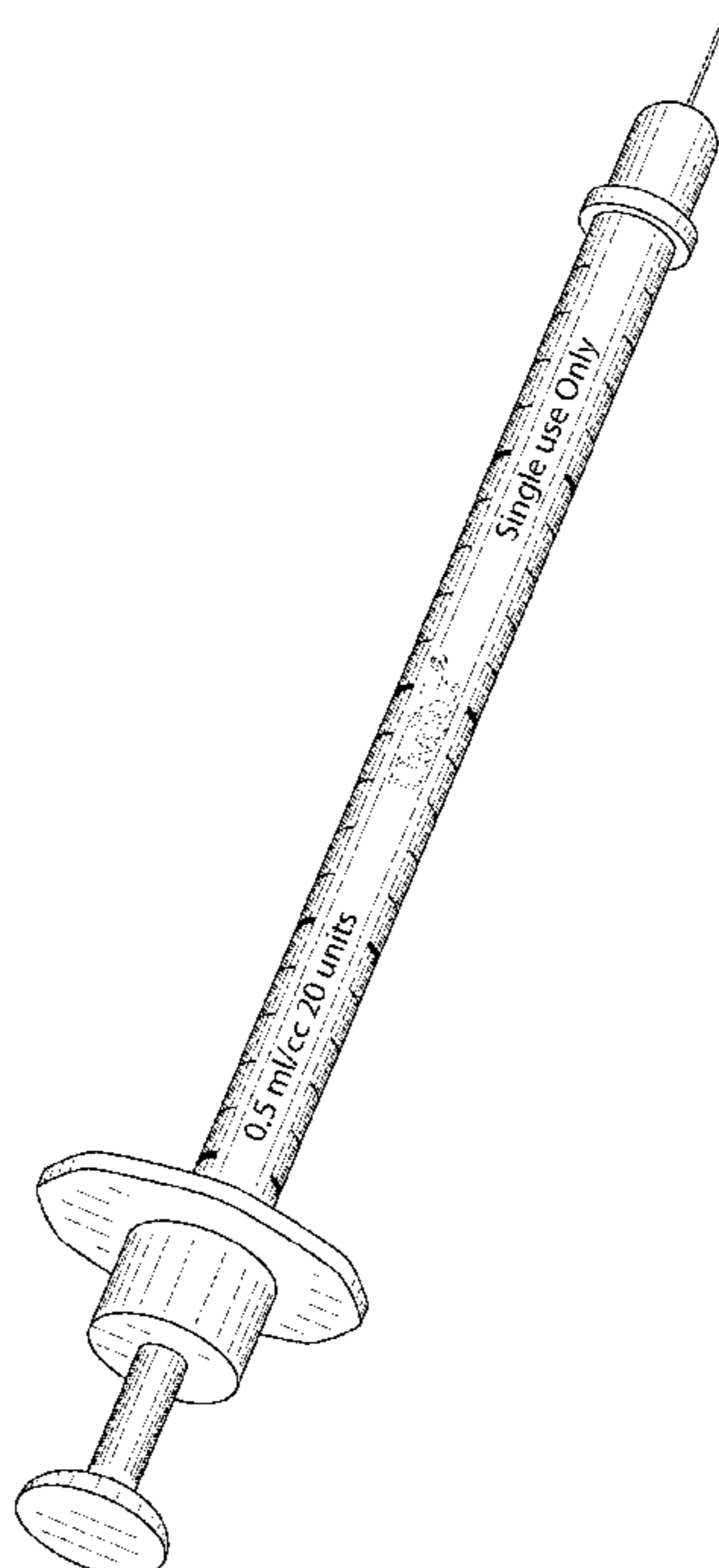

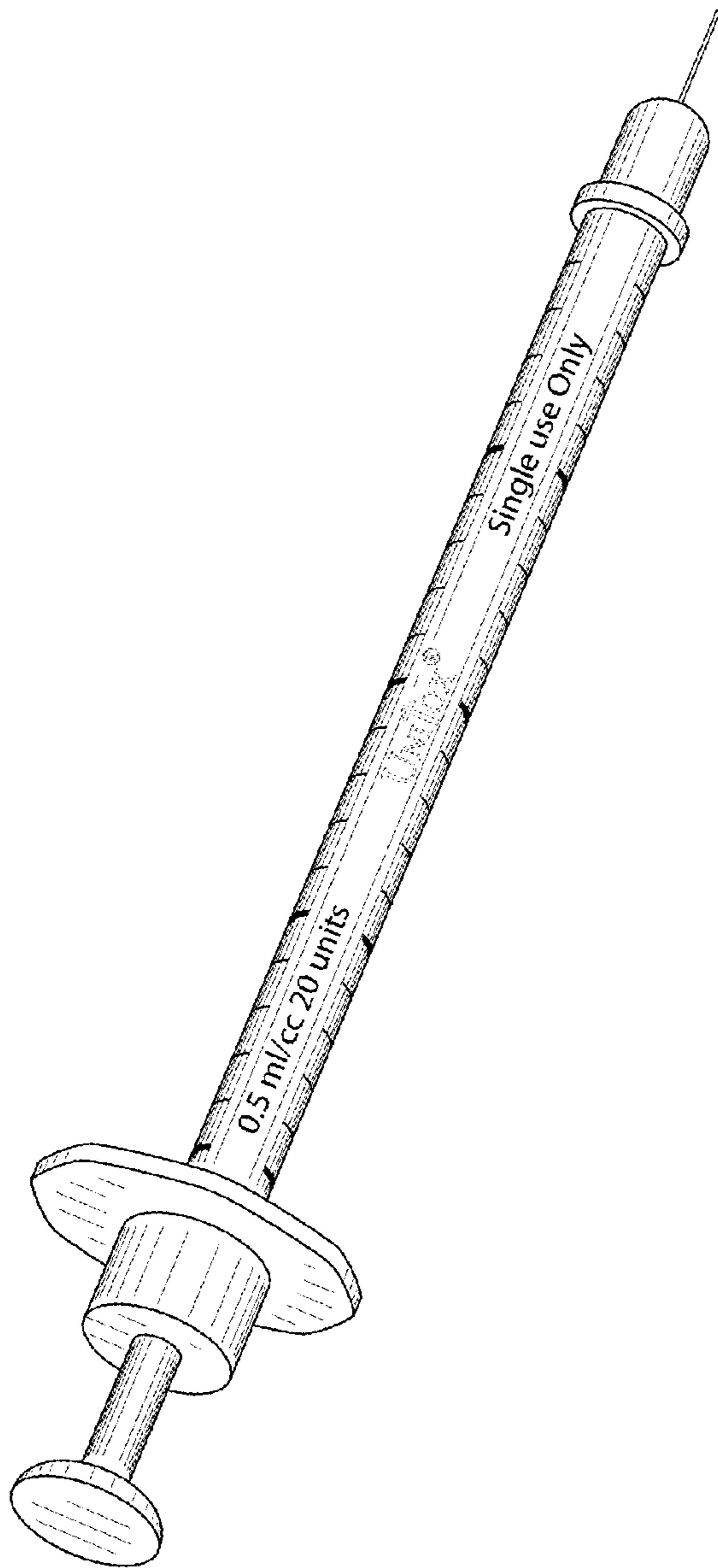

FIG. 1

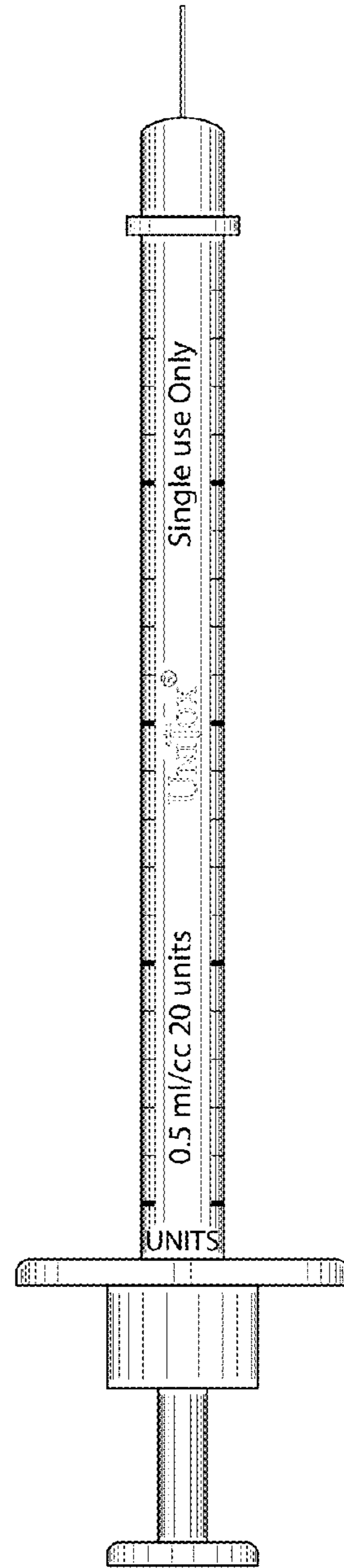

FIG. 2

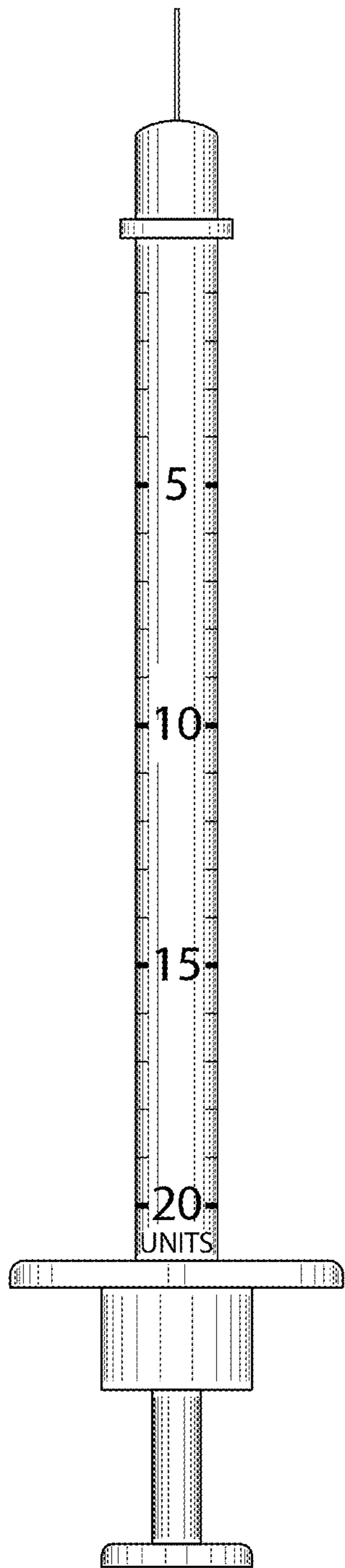

FIG. 3

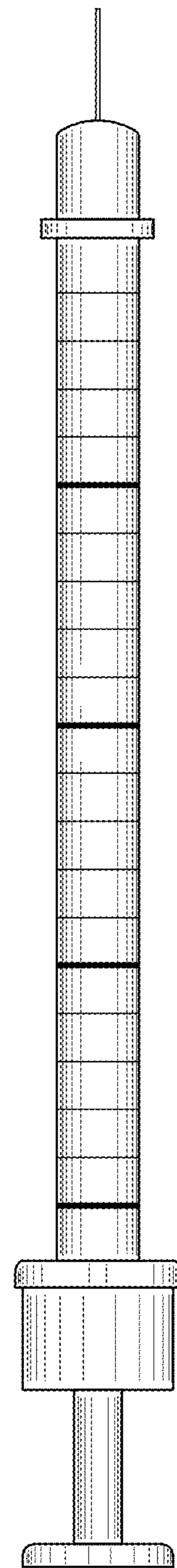

FIG. 4

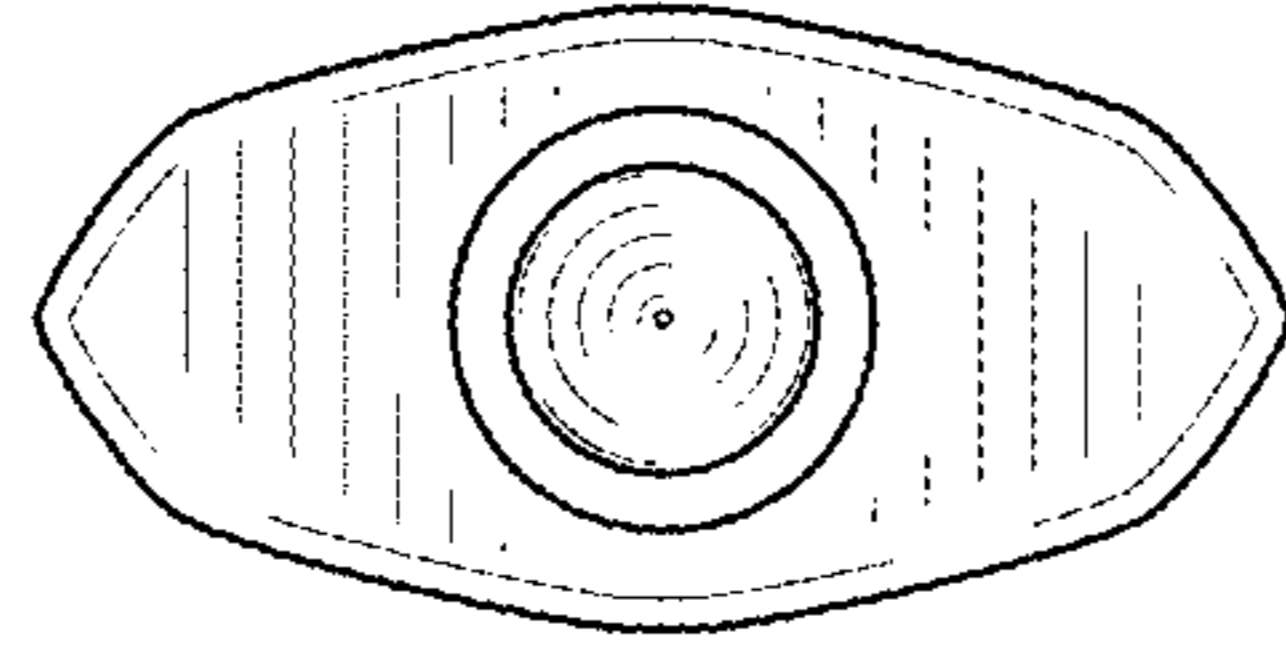

FIG. 5

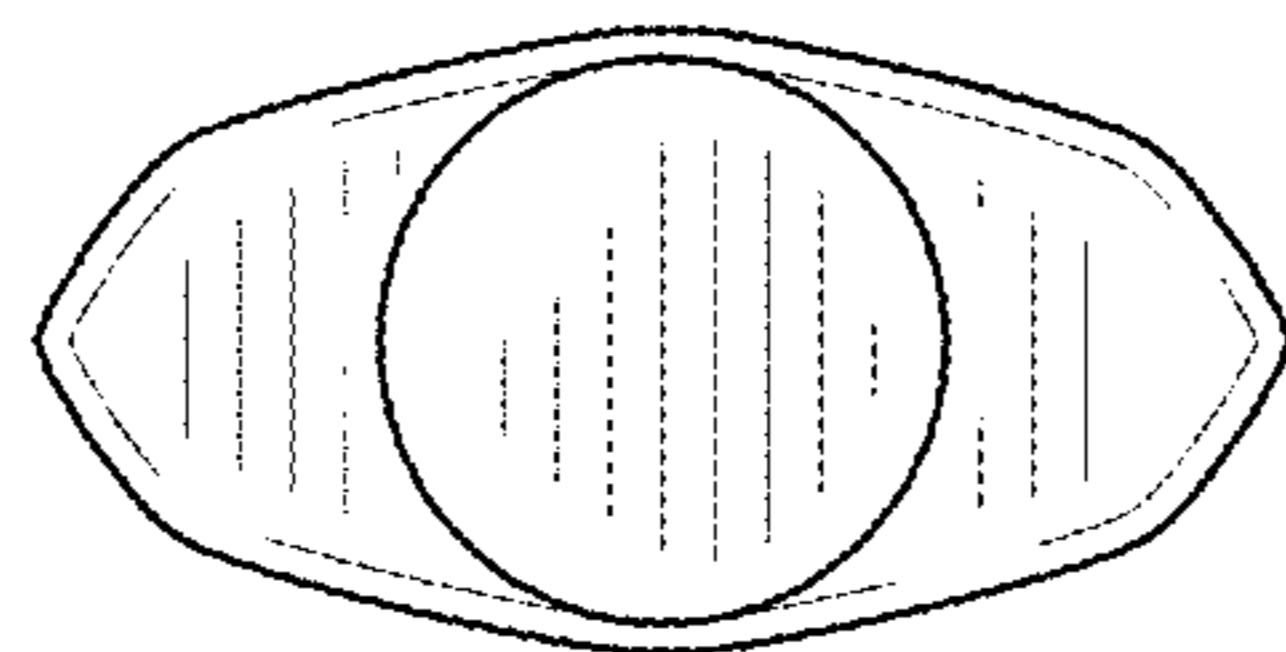

FIG. 6