



US00D690406S

(12) **United States Design Patent**
Seki

(10) **Patent No.:** **US D690,406 S**

(45) **Date of Patent:** **** Sep. 24, 2013**

(54) **AIR-CONDITIONER**

(75) Inventor: **Kouichirou Seki**, Kusatsu (JP)

(73) Assignee: **Daikin Industries Ltd.**, Osaka-Shi (JP)

(**) Term: **14 Years**

(21) Appl. No.: **29/421,641**

(22) Filed: **Aug. 27, 2012**

(30) **Foreign Application Priority Data**

Mar. 23, 2012 (JP) 2012-006680

(51) **LOC (9) Cl.** **23-04**

(52) **U.S. Cl.**
USPC **D23/351**

(58) **Field of Classification Search**
USPC D23/351-354, 385, 355, 357, 361;
312/236; 62/259.1, 259.4, 262-263, 304;
454/330-331, 349-350
See application file for complete search history.

(56) **References Cited**

U.S. PATENT DOCUMENTS

D465,837 S * 11/2002 Hatanaka et al. D23/351
D579,095 S * 10/2008 Nagahori et al. D23/351
D580,038 S * 11/2008 Seki et al. D23/351

D621,920 S * 8/2010 Yamana et al. D23/351
D632,769 S * 2/2011 Seki D23/351
D641,848 S * 7/2011 Seki D23/351
D642,250 S * 7/2011 Chouji D23/351

* cited by examiner

Primary Examiner — Brian N Vinson

(74) *Attorney, Agent, or Firm* — Manabu Kanesaka

(57) **CLAIM**

The ornamental design for an air-conditioner, as shown and described.

DESCRIPTION

FIG. 1 is a perspective view of an air-conditioner showing my new design;
FIG. 2 is a front view thereof;
FIG. 3 is a rear view thereof;
FIG. 4 is a plan view thereof;
FIG. 5 is a bottom view thereof;
FIG. 6 is a left side view thereof;
FIG. 7 is a right side view thereof;
FIG. 8 is a perspective view thereof in the used state; and,
FIG. 9 is a cross-sectional view thereof taken along the line 9-9 in FIG. 2.

The broken lines depict portions of the air-conditioner that form no part of claimed design.

1 Claim, 8 Drawing Sheets

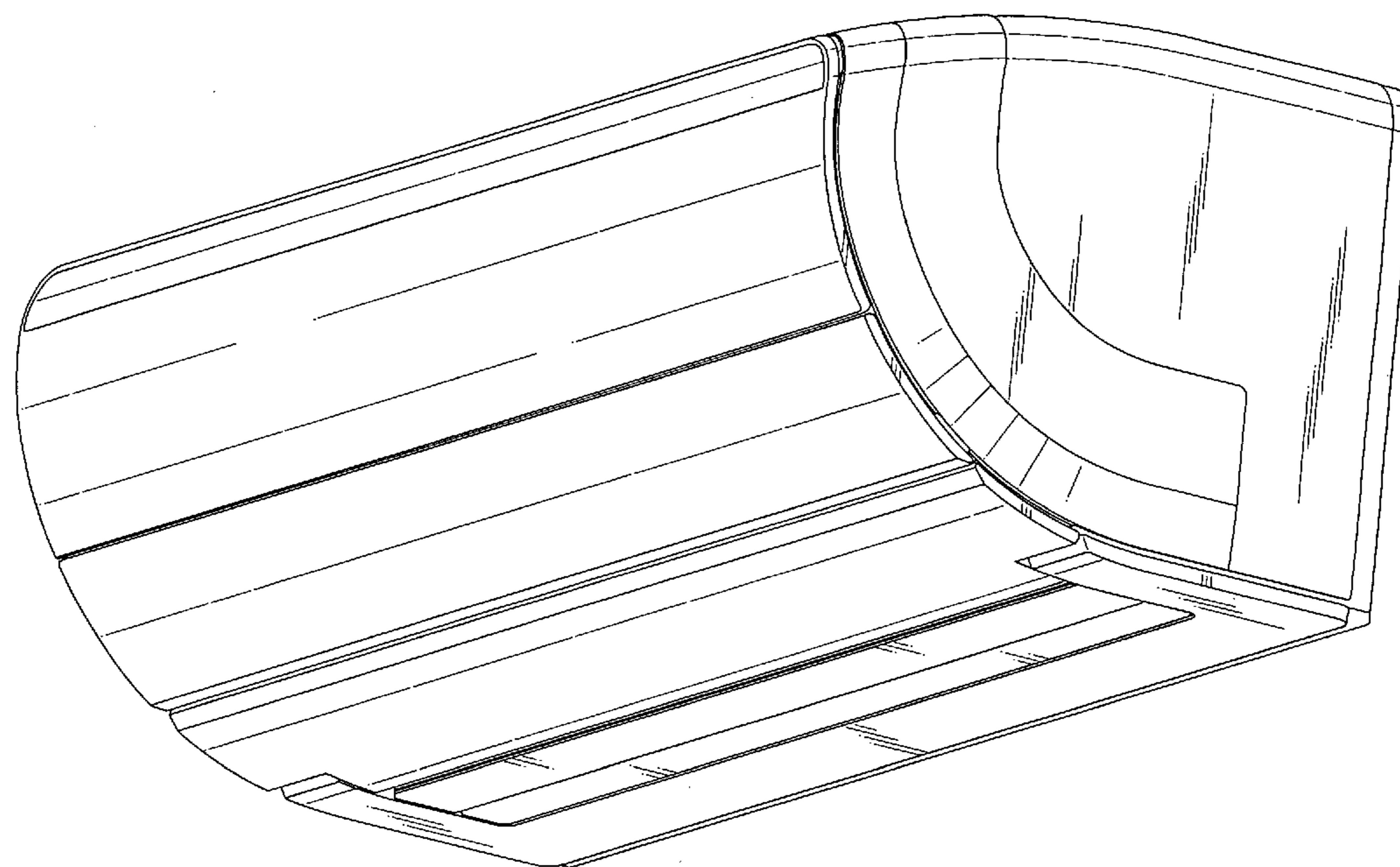

Fig. 1

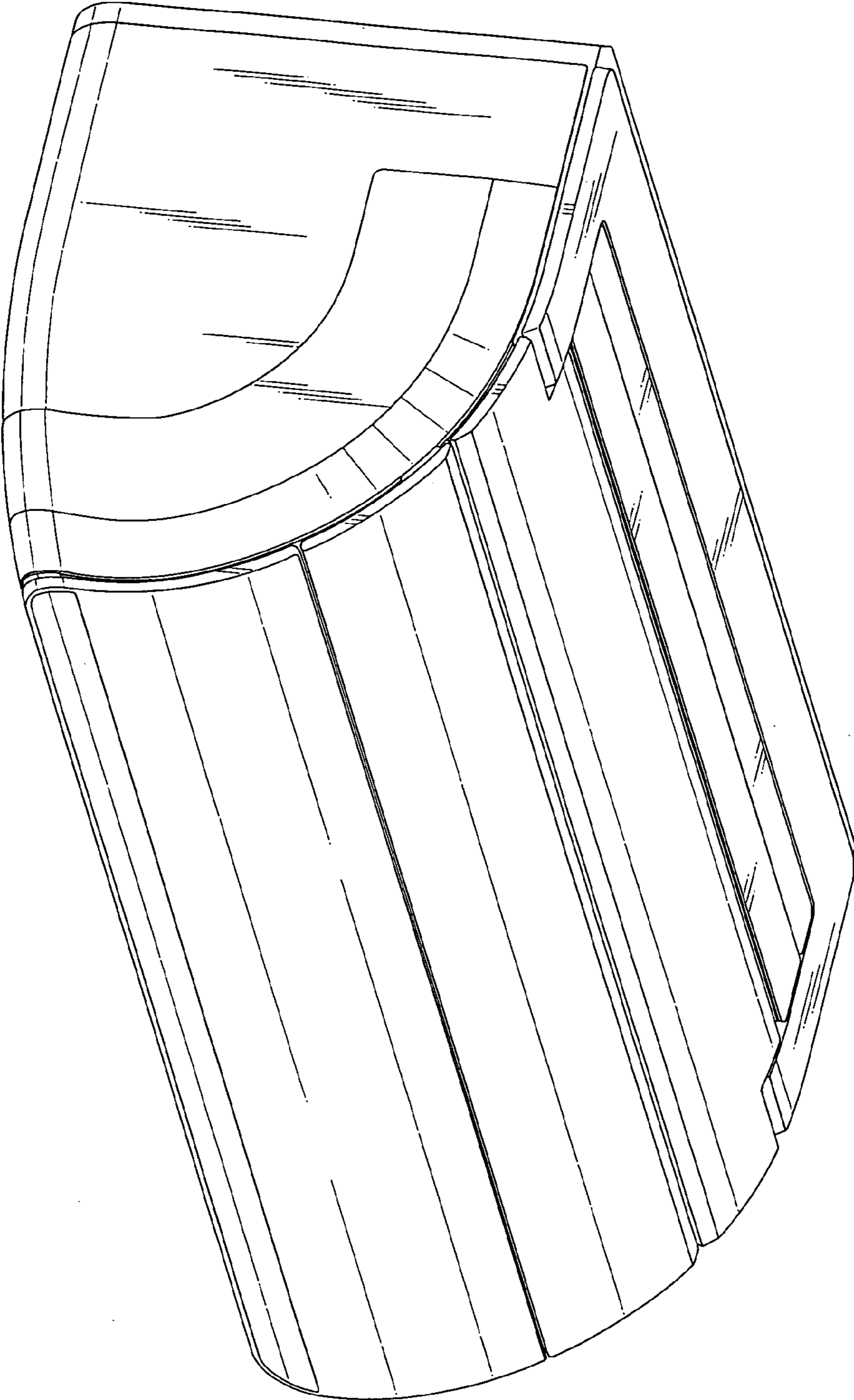

Fig. 2

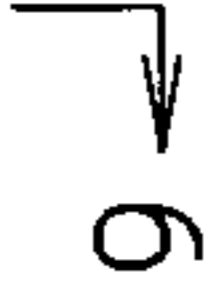
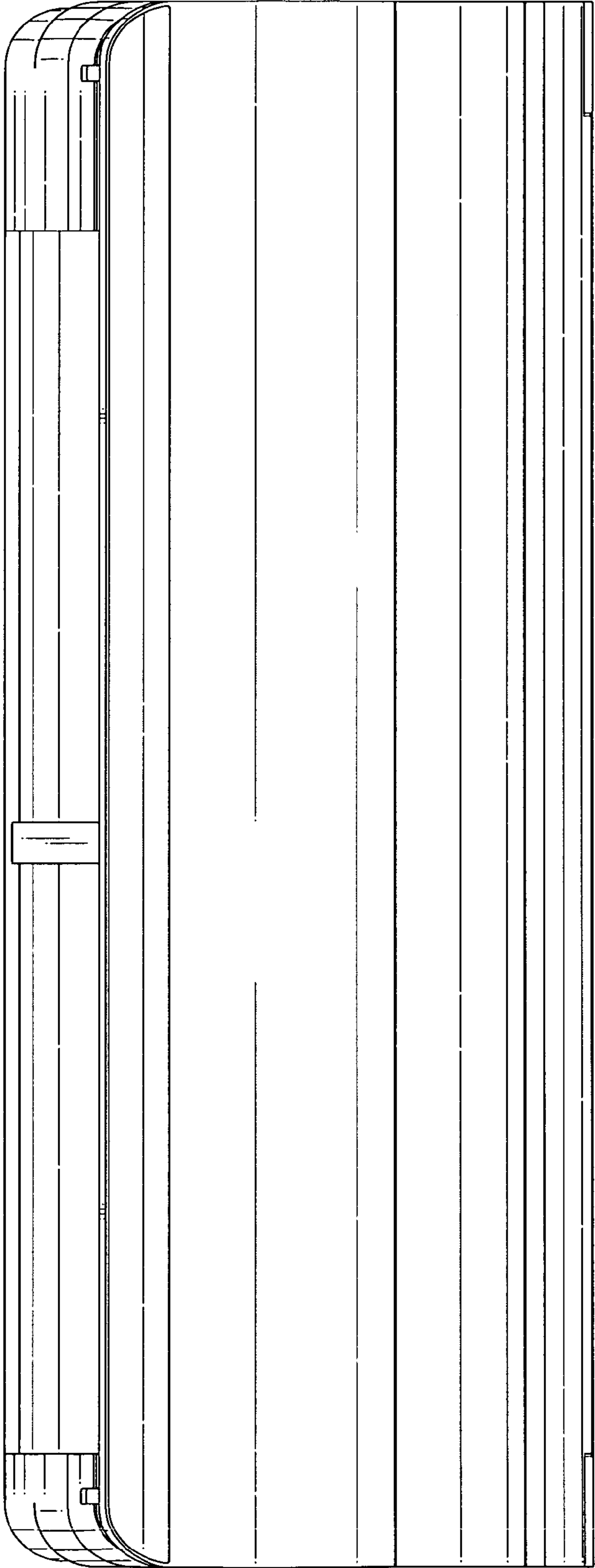
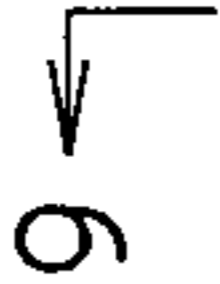

Fig. 3

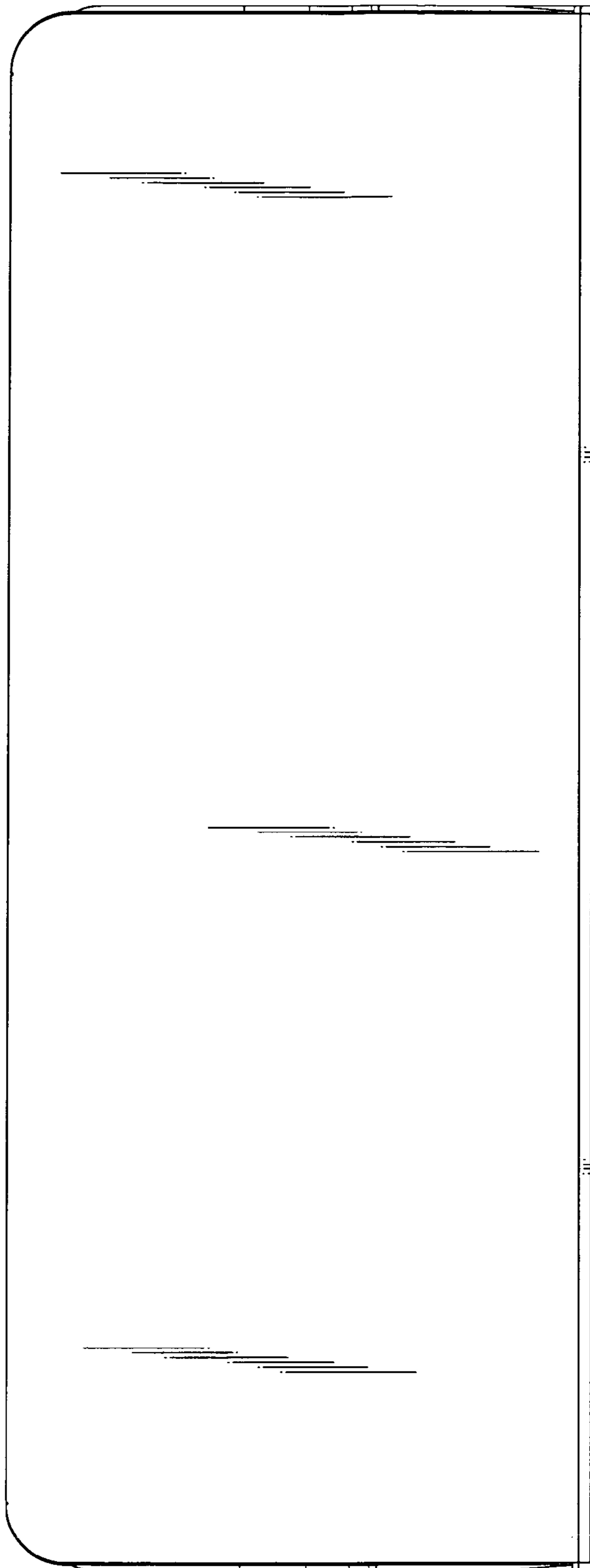

Fig. 4

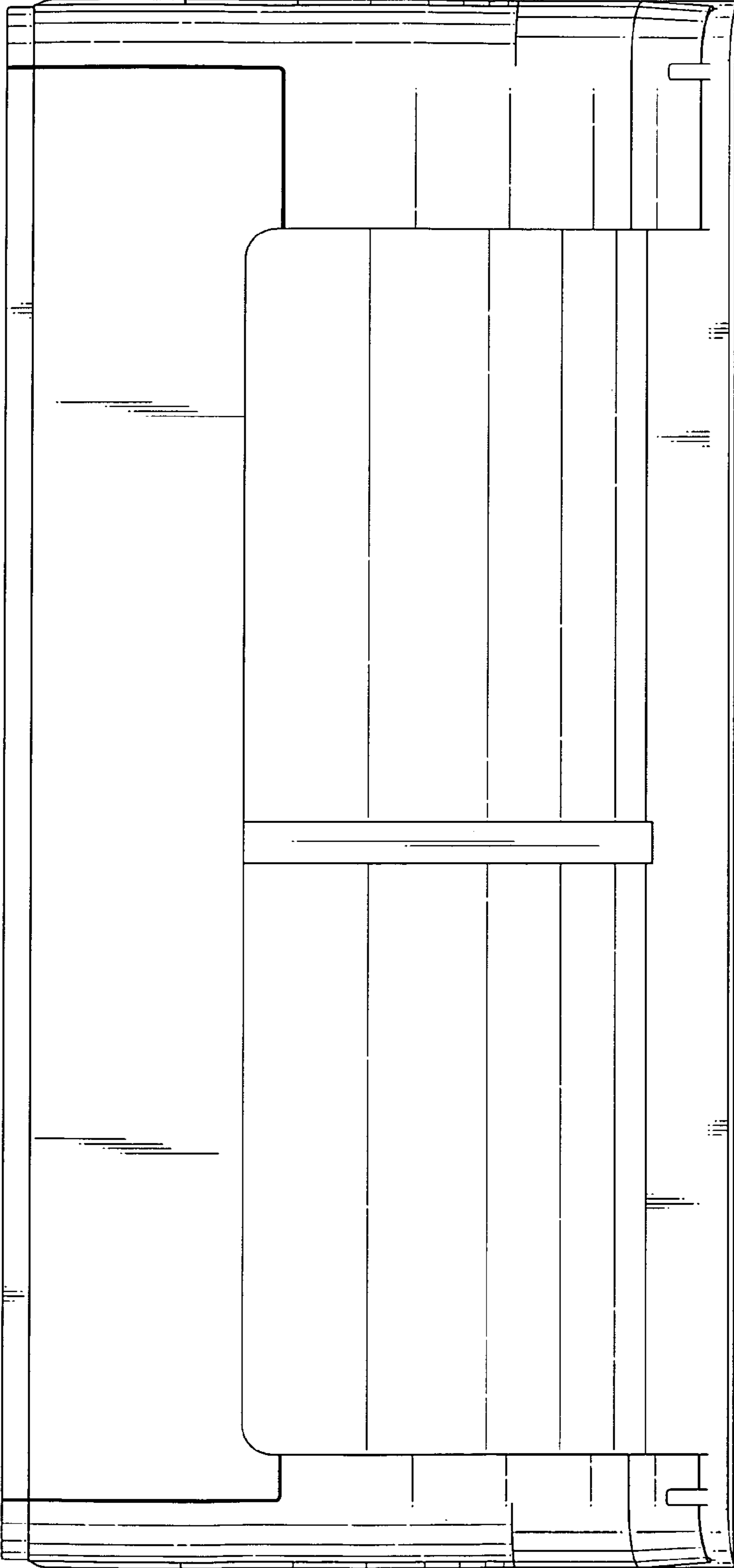

Fig. 5

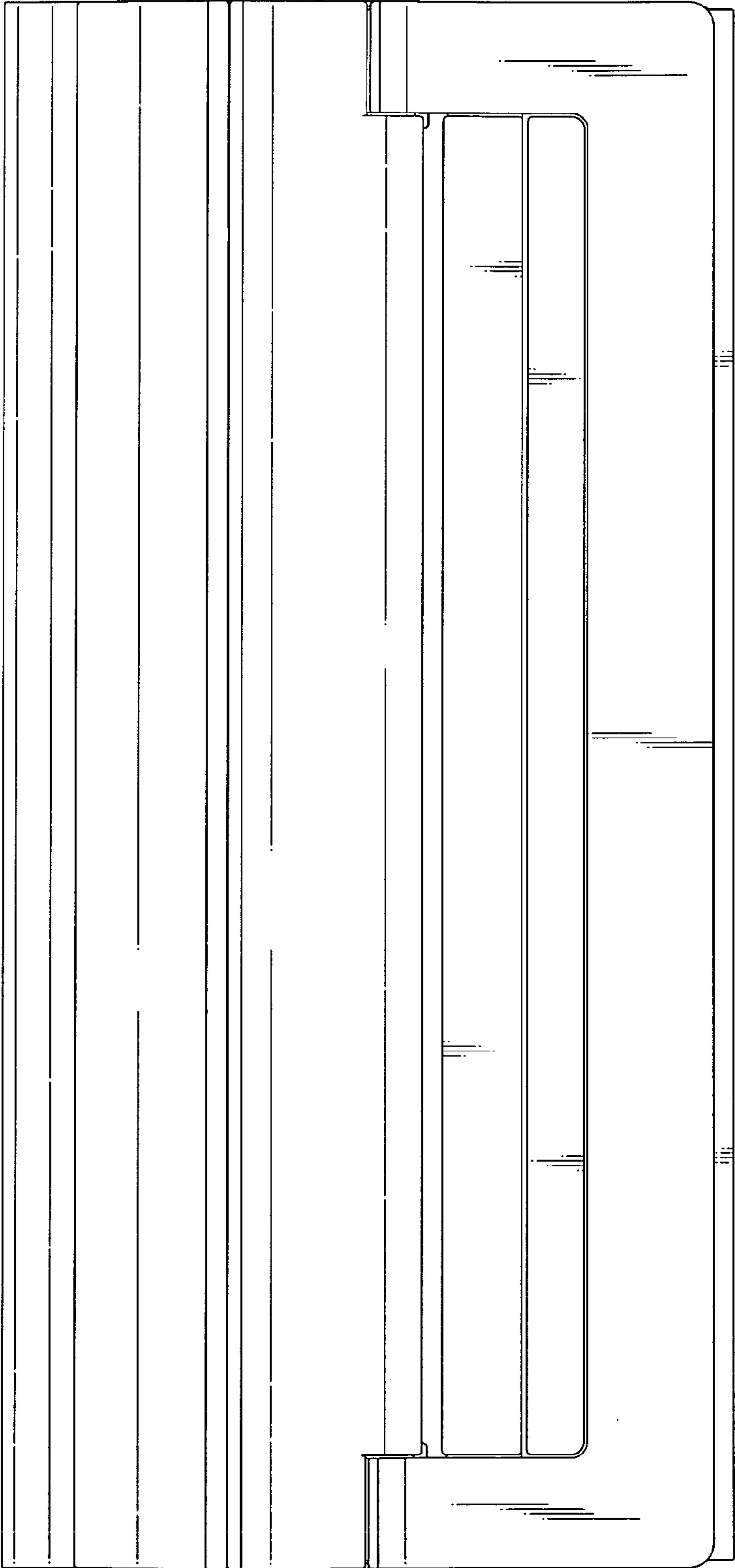

Fig. 7

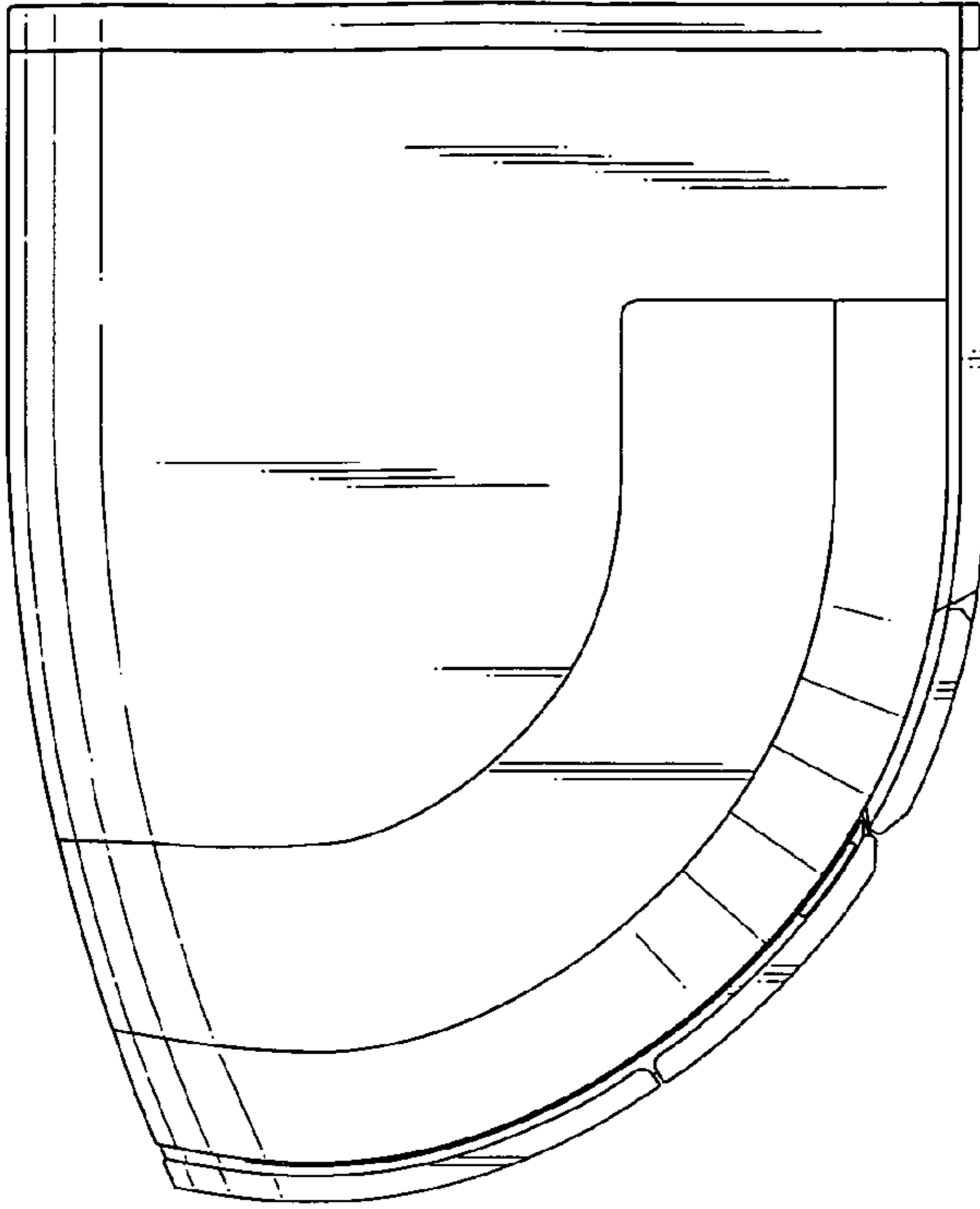

Fig. 6

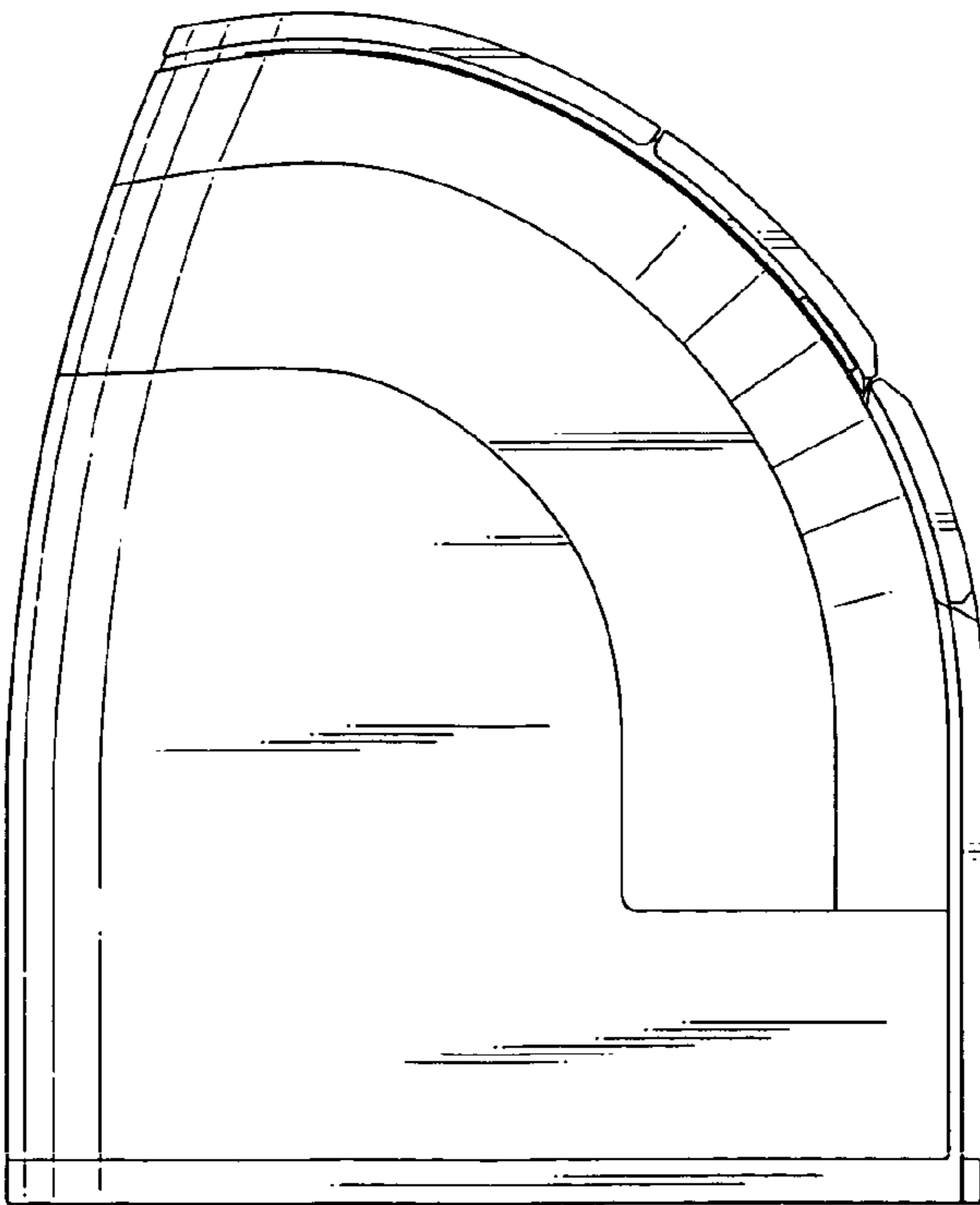

Fig. 8

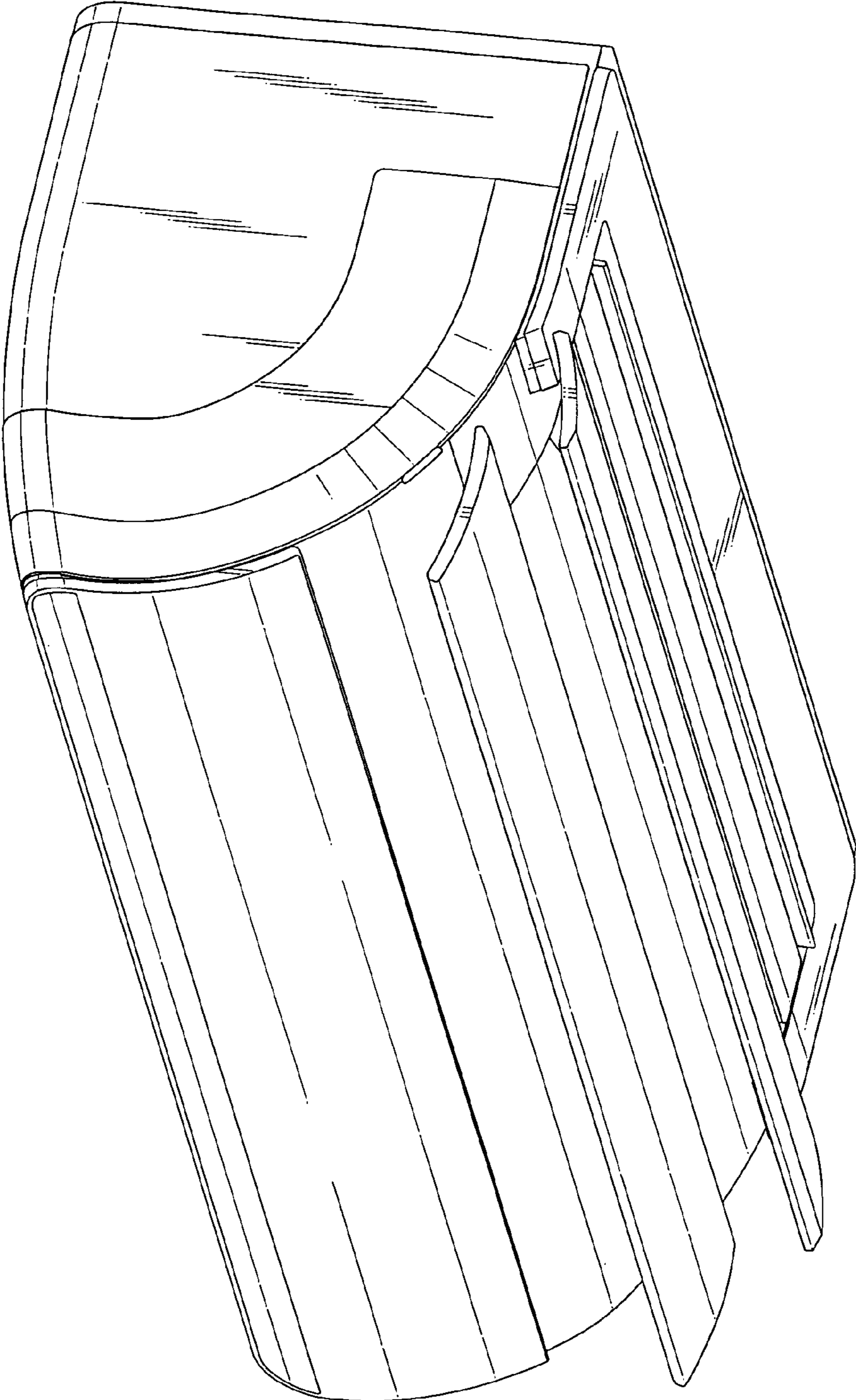

Fig. 9

