



US00D690357S

(12) **United States Design Patent**
Liang

(10) **Patent No.:** **US D690,357 S**

(45) **Date of Patent:** **** Sep. 24, 2013**

- (54) **PEN**
- (75) **Inventor:** **Wenyan Liang**, Ningbo (CN)
- (73) **Assignee:** **Beifa Group Co., Ltd.**, Ningbo (CN)
- (**) **Term:** **14 Years**
- (21) **Appl. No.:** **29/405,745**
- (22) **Filed:** **Nov. 4, 2011**
- (30) **Foreign Application Priority Data**
May 4, 2011 (CN) 2011 3 0102932
- (51) **LOC (9) Cl.** **19-06**
- (52) **U.S. Cl.**
USPC **D19/50**
- (58) **Field of Classification Search**
USPC D14/411; D19/35, 36, 41-51, 54-58;
24/11 F, 11 P, 11 R; 401/52, 99-109, 192,
401/195, 196
See application file for complete search history.

- D576,212 S * 9/2008 Qiu et al. D19/47
- D591,351 S * 4/2009 Shi D19/50
- D608,392 S * 1/2010 Shibata D19/50
- D616,499 S * 5/2010 Liu D19/50
- D641,411 S 7/2011 Tan

OTHER PUBLICATIONS

Jiang, L., "Pen," U.S. Appl. No. 29/404,070, filed Oct. 14, 2011.
Liang, W., "Pen," U.S. Appl. No. 29/405,747, filed Nov. 4, 2011.
Yuan, F., Pen, U.S. Appl. No. 29/396,506, filed Jun. 30, 2011.

* cited by examiner

Primary Examiner — Elizabeth Albert

(74) *Attorney, Agent, or Firm* — Christensen O'Connor Johnson Kindness PLLC

(57) **CLAIM**

The ornamental design for a pen, as shown and described.

DESCRIPTION

FIG. 1 is an upper front right perspective view of a pen showing my new design;
FIG. 2 is a front elevation view thereof;
FIG. 3 is a rear elevation view thereof;
FIG. 4 is a right side elevation view thereof, with the left side elevation view being a mirror image of the right side elevation view;
FIG. 5 is an enlarged top plan view thereof; and,
FIG. 6 is an enlarged bottom plan view thereof.
The broken lines shown in FIG. 6 illustrate environmental subject matter and form no part of the claimed design.

1 Claim, 4 Drawing Sheets

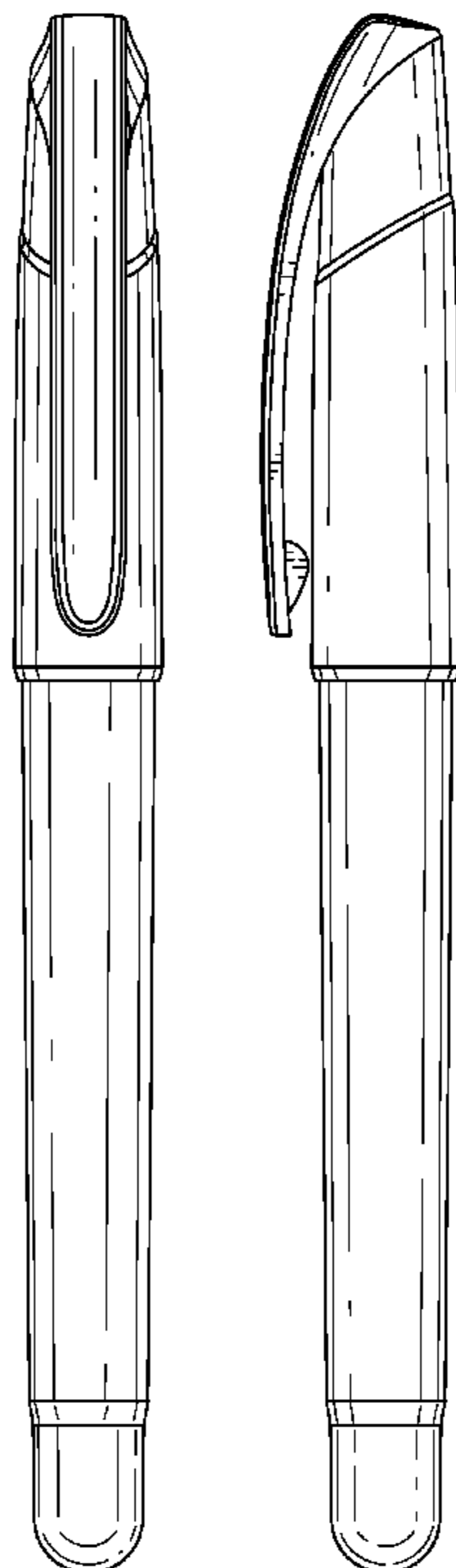

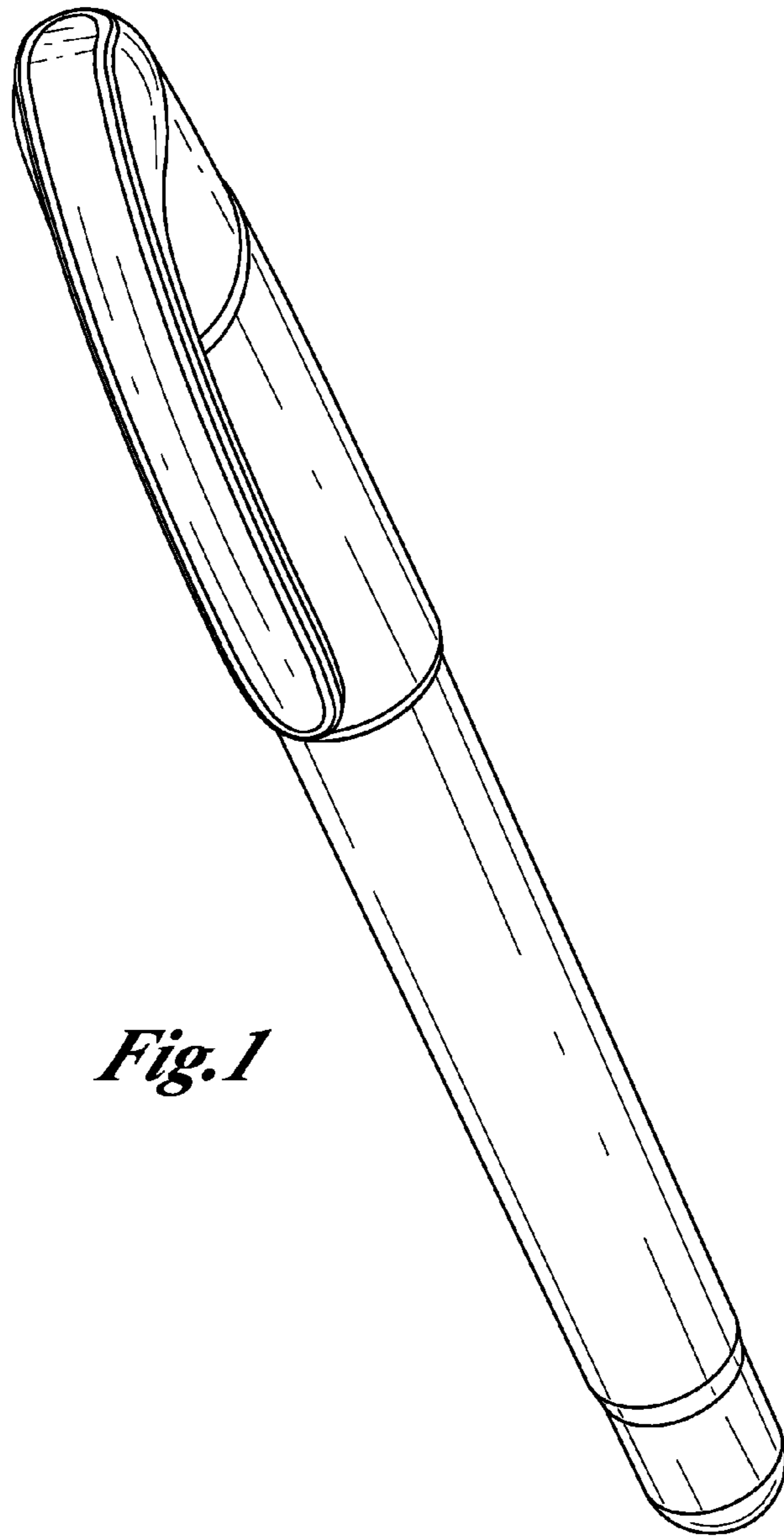

Fig. 1

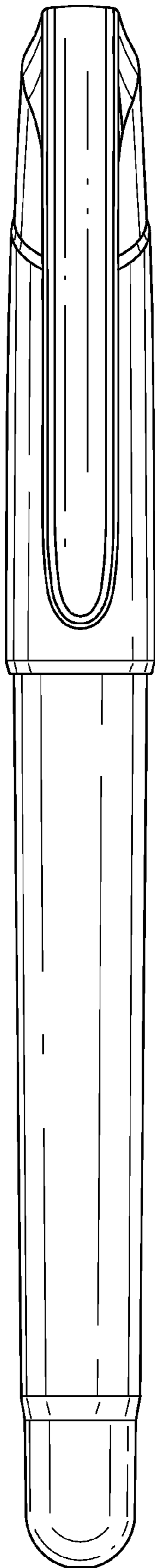

Fig. 2

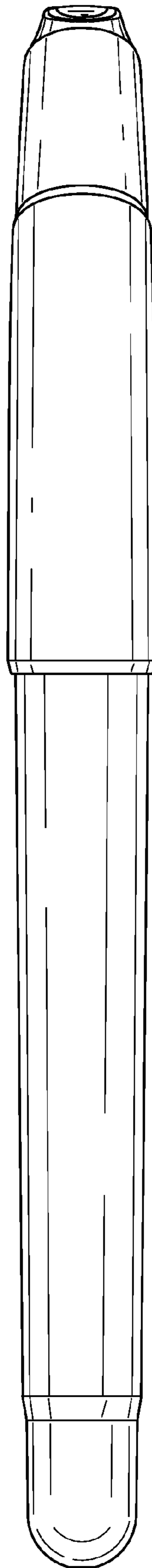

Fig. 3

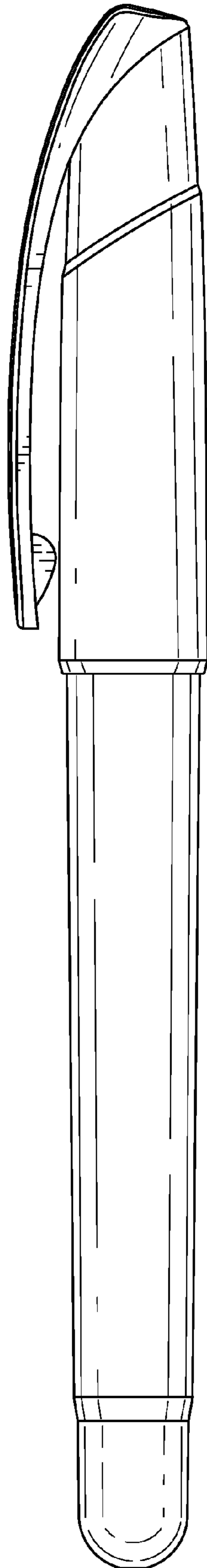

Fig. 4

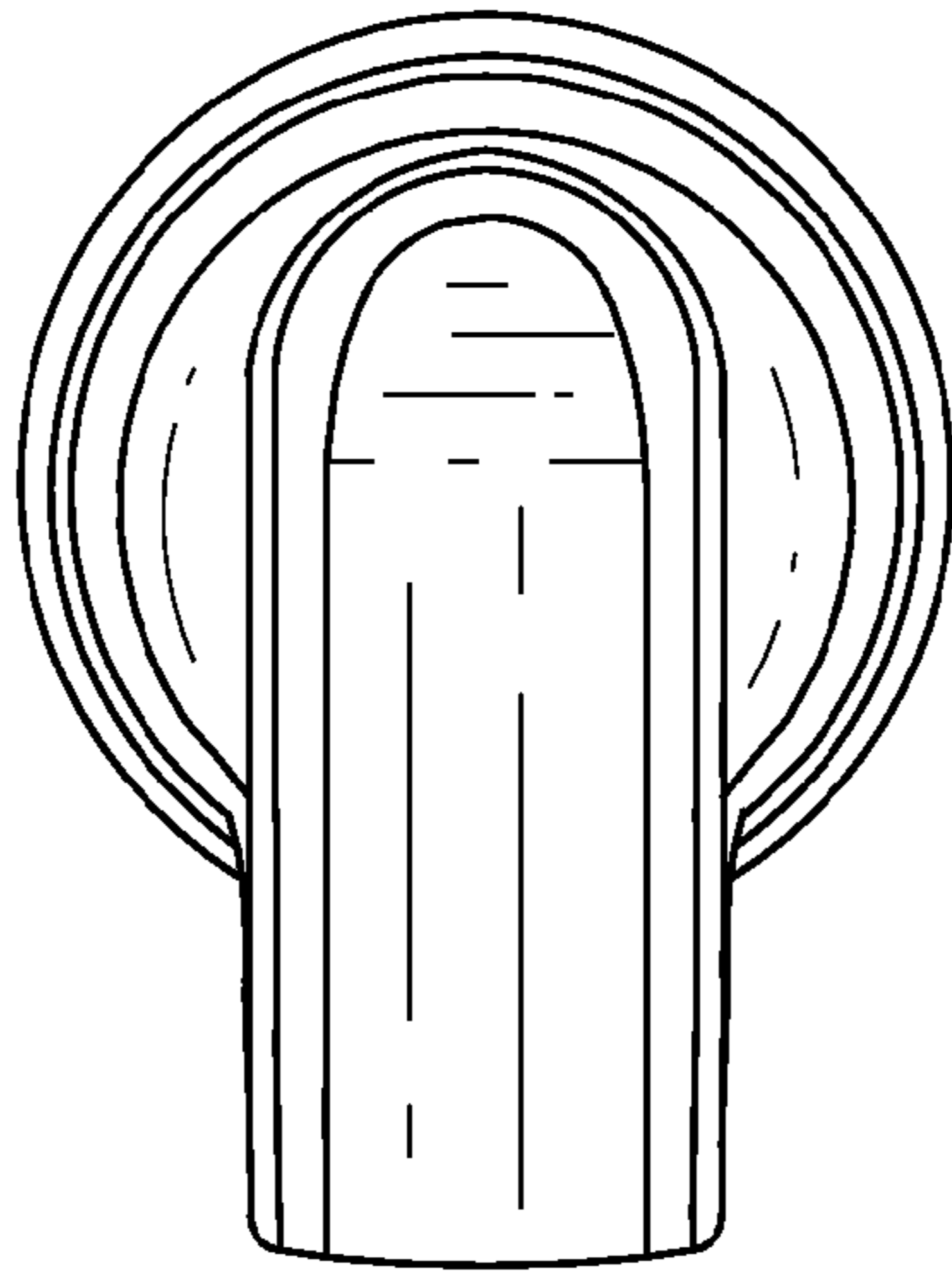

Fig. 5

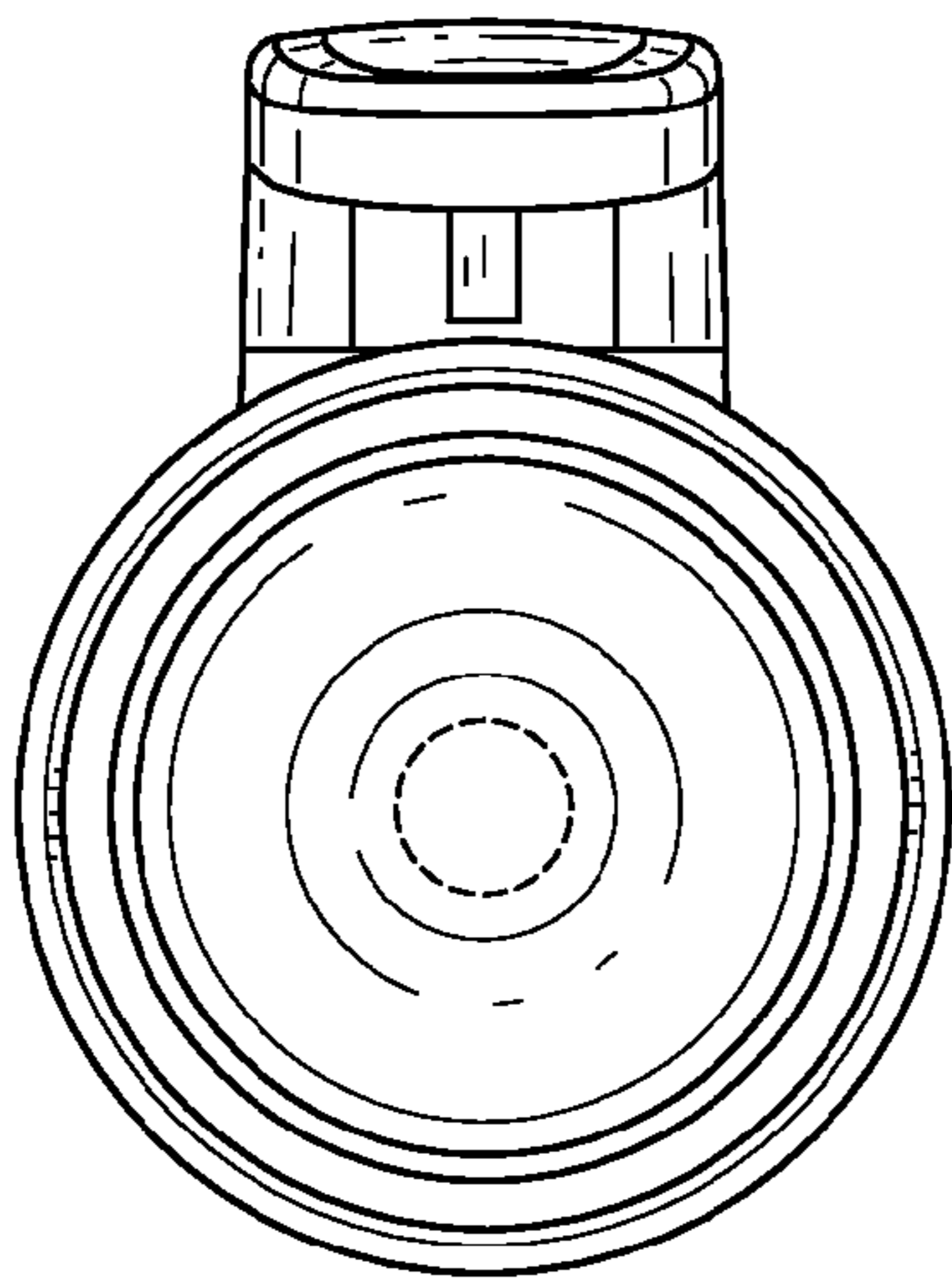

Fig. 6