



US00D690292S

(12) **United States Design Patent**
Bibla et al.

(10) **Patent No.:** **US D690,292 S**

(45) **Date of Patent:** **** Sep. 24, 2013**

(54) **PHONE SKIN COVER**

(75) Inventors: **Marvin Jeffery Bibla**, Thornhill (CA);
Jahnhoj Zeon Benjamin Coombs,
Tornoto (CA)

(73) Assignee: **GENTEC (Canadian partnership**
consisting of 901089 Ontario Limited
and Days Fashions Limited), Markham,
Ontario (CA)

(**) Term: **14 Years**

(21) Appl. No.: **29/427,071**

(22) Filed: **Jul. 13, 2012**

(30) **Foreign Application Priority Data**

Jan. 13, 2012 (CA) 143936

(51) **LOC (9) Cl.** **14-03**

(52) **U.S. Cl.**
USPC **D14/250**

(58) **Field of Classification Search**

USPC D14/250–253, 440, 203.3–203.7,
D14/217, 496, 248, 238.1, 240, 447, 341–347,
D14/444; D13/103, 107–108, 119; D3/201,
D3/218, 247, 269, 273, 301, 303; 248/309.1,
248/371, 176.3, 668; 361/679.56, 679.3,
361/679.25, 816; 379/426, 433.11, 455;
455/575.1, 575.8; 206/305, 320; 320/108,
320/115; 429/96; 220/4.02; 150/165

See application file for complete search history.

(56) **References Cited**

U.S. PATENT DOCUMENTS

D328,077 S * 7/1992 Gradl D14/250
D585,640 S * 2/2009 Case D3/218

(Continued)

OTHER PUBLICATIONS

Media Release: Gentec Roots Tuff Skin Cases Available for iPhone 4,
published on Aug. 4, 2010, <URL: <http://www.gentec-intl.com/2010/>

08/04/roots-tuff-skin-cases-now-available-for-iphone-4-offering-
maximum-protection-in-a-choice-of-eight-colours/>, retrieved from
internet on Jun. 6, 2013.*

(Continued)

Primary Examiner — Carla Jobe Wright

(74) *Attorney, Agent, or Firm* — Fitzpatrick, Cella, Harper &
Scinto

(57) **CLAIM**

The ornamental design for a phone skin cover, as shown and
described.

DESCRIPTION

FIG. 1 is a front perspective view of a phone skin cover, with
a detailed enlargement of a section of the phone skin cover to
show the surface configuration that is present on all exterior
surfaces except the buttons;

FIG. 2 is a front elevation view of the phone skin cover of FIG.
1;

FIG. 3 is a rear elevation view of the phone skin cover of FIG.
1;

FIG. 4 is a right side elevation view of the phone skin cover of
FIG. 1;

FIG. 5 is a left side elevation view of the phone skin cover of
FIG. 1;

FIG. 6 is a bottom plan view of the phone skin cover of FIG.
1; and,

FIG. 7 is a top plan view of the phone skin cover of FIG. 1.

The characteristic feature of our design for a phone skin cover
resides in a rubber membrane with a raised diamond-shaped
grid on those surfaces of the phone skin cover which are
identified by cross-hatching in FIGS. 1 through 7.

The broken lines in FIGS. 5 and 7 depict unclaimed environ-
ment. The broken lines in FIG. 1 are to indicate the portion of
the phone skin cover that is shown on an enlarged scale. The
broken lines form no part of the claimed design.

1 Claim, 5 Drawing Sheets

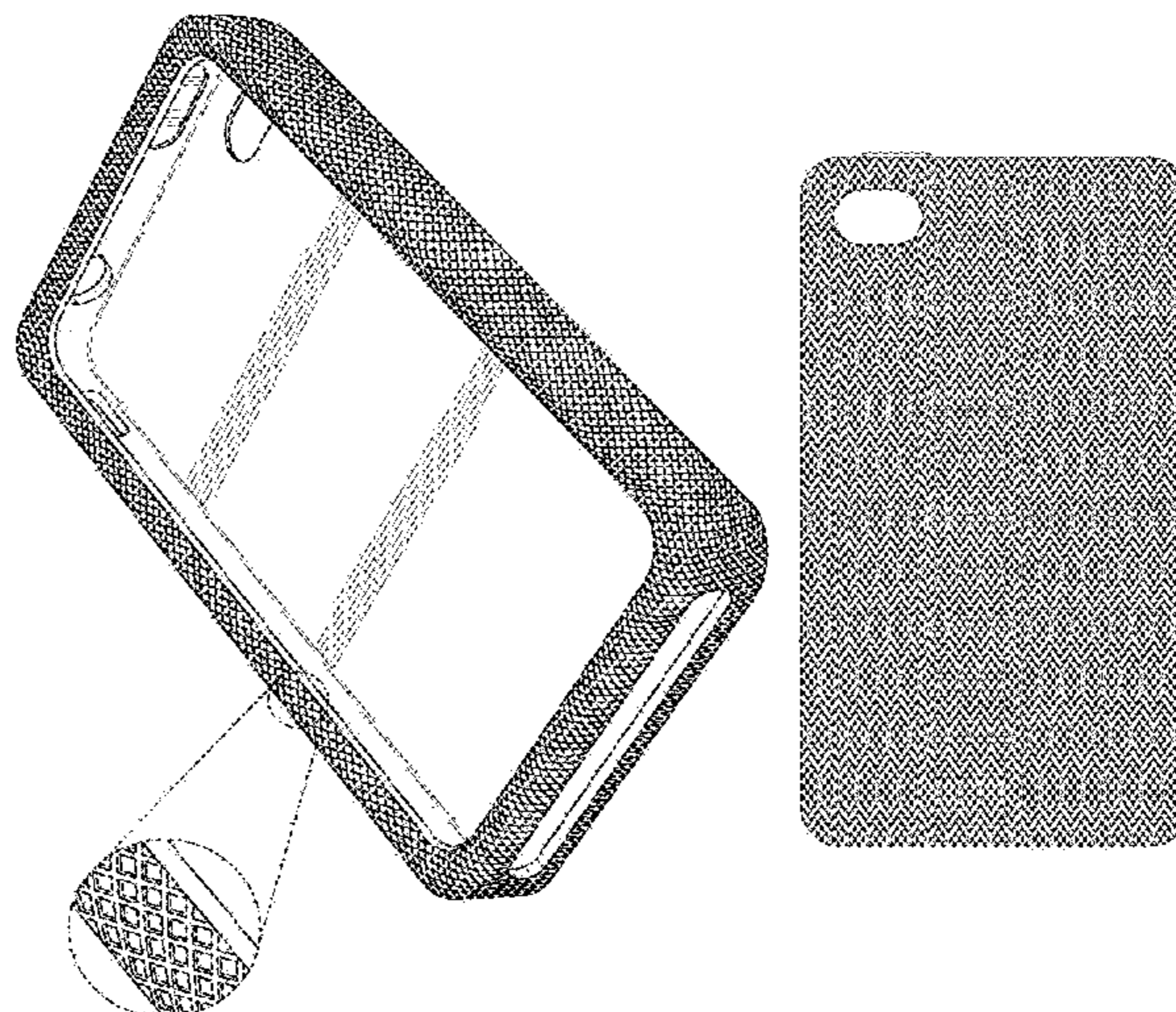

(56)

References Cited

U.S. PATENT DOCUMENTS

D597,298 S * 8/2009 Lown et al. D3/202
D598,438 S 8/2009 Seo
D606,532 S 12/2009 de Jong et al.
D606,986 S 12/2009 de Jong et al.
D614,402 S * 4/2010 Lown et al. D3/303
D634,313 S * 3/2011 Fitzpatrick et al. D14/250
D640,246 S * 6/2011 Liu et al. D14/248
8,024,016 B2 9/2011 Lim et al.
D649,144 S * 11/2011 Fathollahi D14/250
D667,822 S * 9/2012 Li D14/248
D668,646 S * 10/2012 Li D14/248
D669,889 S * 10/2012 Li et al. D14/248
D671,933 S * 12/2012 Rodgers D14/250
D673,159 S * 12/2012 McCarthy et al. D14/440
D675,605 S * 2/2013 Adelman et al. D14/250
D675,606 S * 2/2013 Adelman et al. D14/250
D682,816 S * 5/2013 Fathollahi D14/250

D683,136 S * 5/2013 Wilson et al. D3/218
8,443,971 B1 * 5/2013 Green et al. 206/320
2009/0140016 A1 * 6/2009 Case et al. 224/197

OTHER PUBLICATIONS

Anaheim Ducks NHL Classic Hockey iPuck Case, by Gamewear, Inc., www.amazon.com (2011).
Boston Bruins NHL Classic Hockey Cell Phone Case, by Gamewear, Inc., www.amazon.com (2011).
Chicago Blackhawks iPod Touch 4th Gen MVP Case, by Tribeca, www.amazon.com (2011).
New Jersey Devils Black Game Wear Hockey Puck Cell Phone Case, www.fanatics.com, (2011).
iPhone 4 Defender Series Case, www.otterbox.com (Nov. 18, 2011).
Ipod Touch 4th generation Dallas Stars MVP NHL hard case, www.ebay.com (Nov. 22, 2011).
OEM Motorola DROID RAZR MAXX Shell Combo w/Holster & Kickstand, OEM Systems Company, www.amazon.com (Jul. 2012).

* cited by examiner

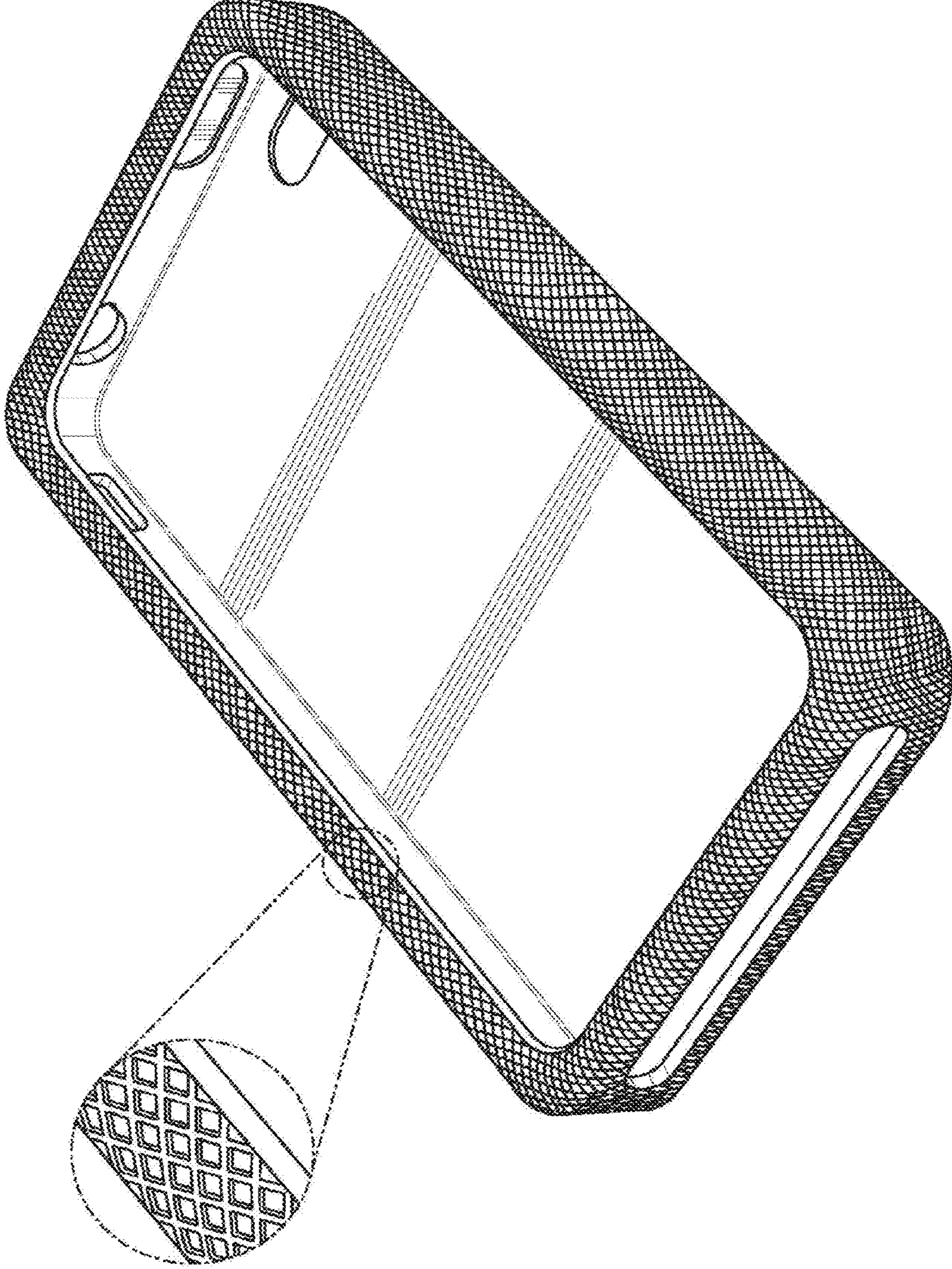

FIG. 1

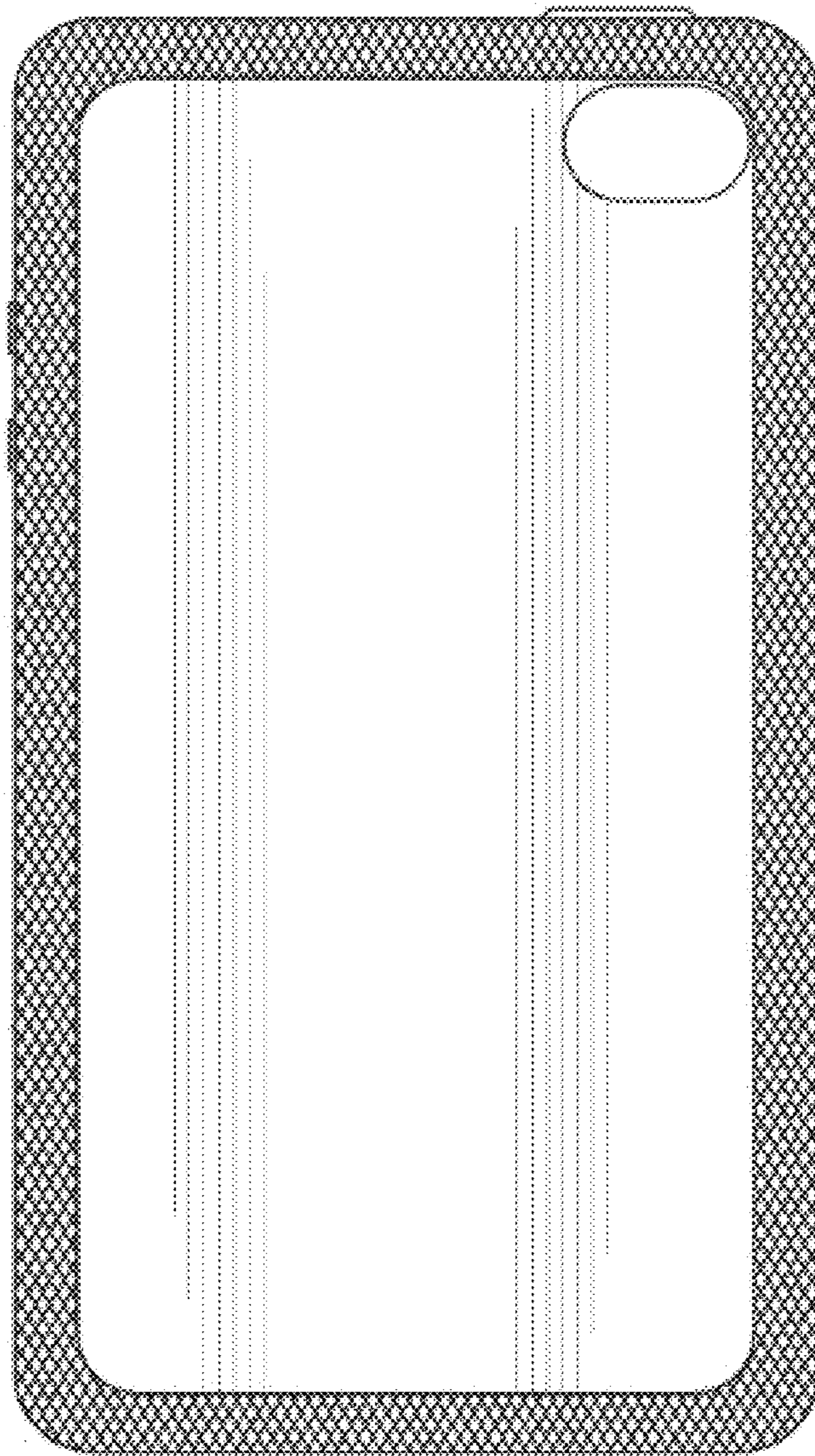

FIG. 2

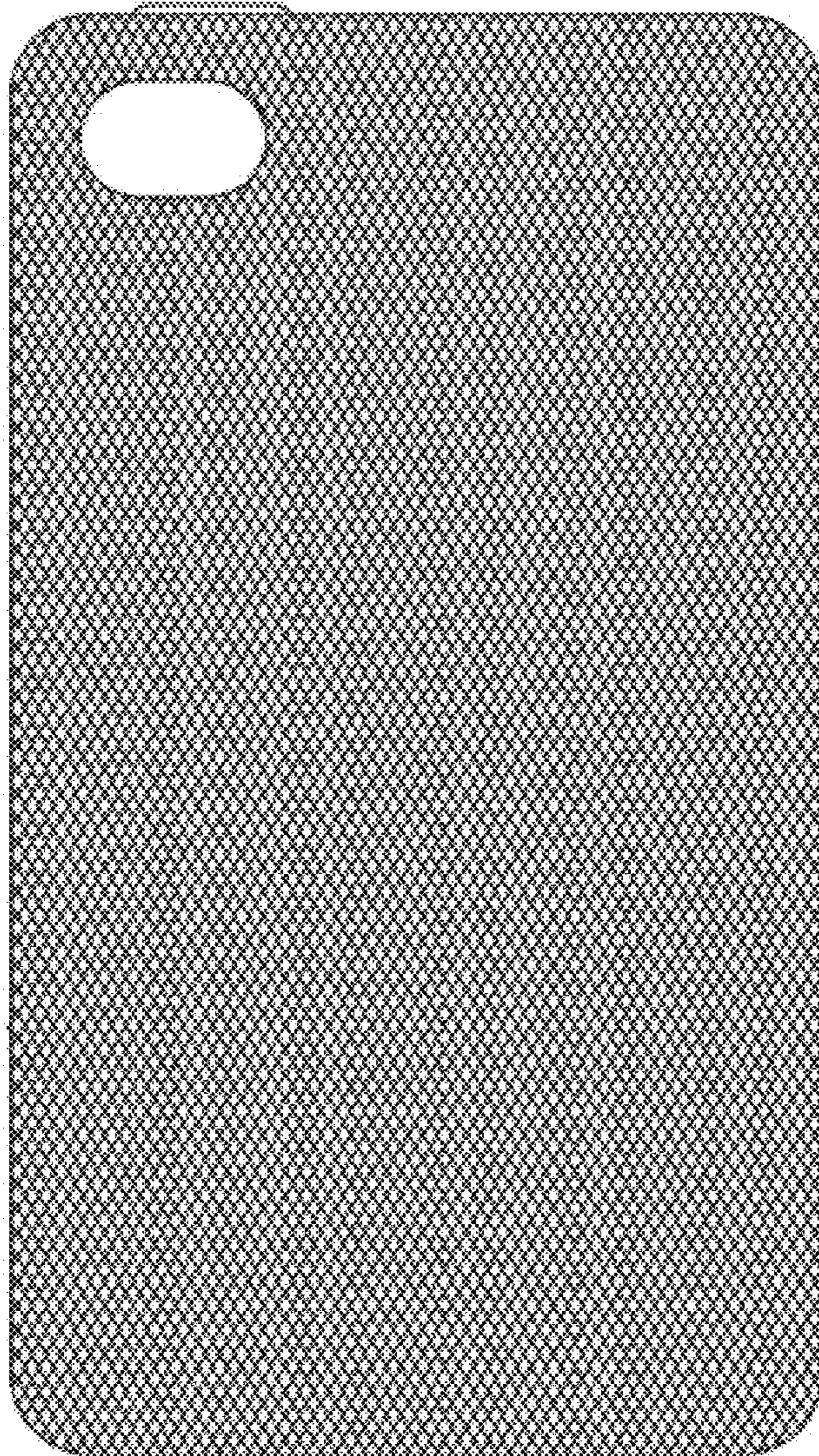

FIG. 3

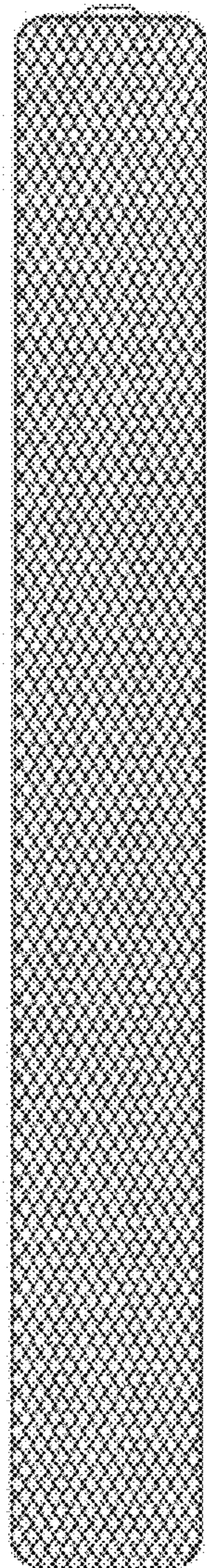

FIG. 4

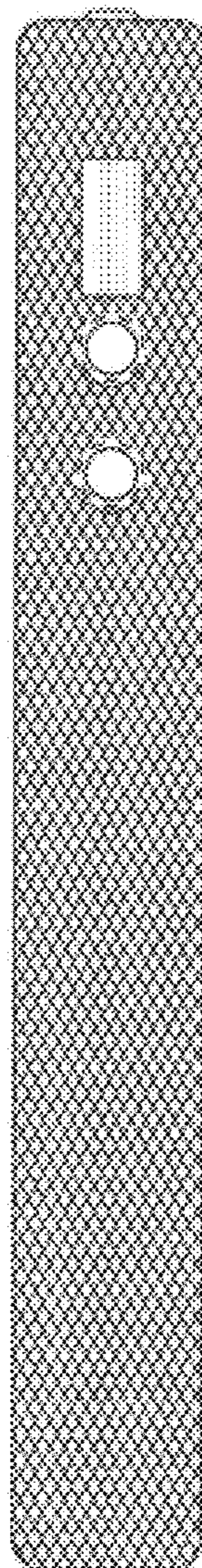

FIG. 5

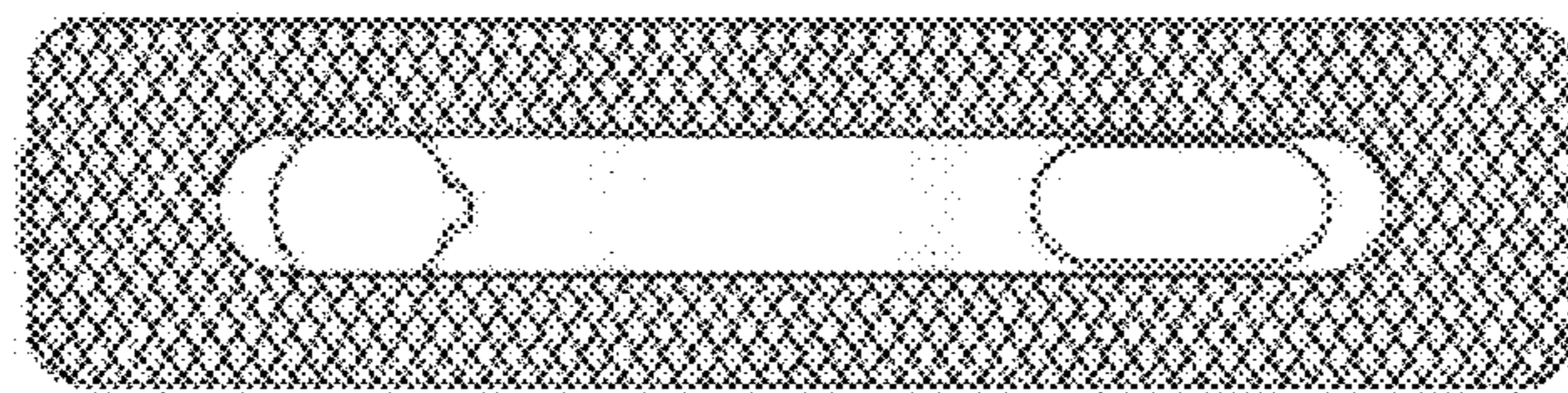

FIG. 6

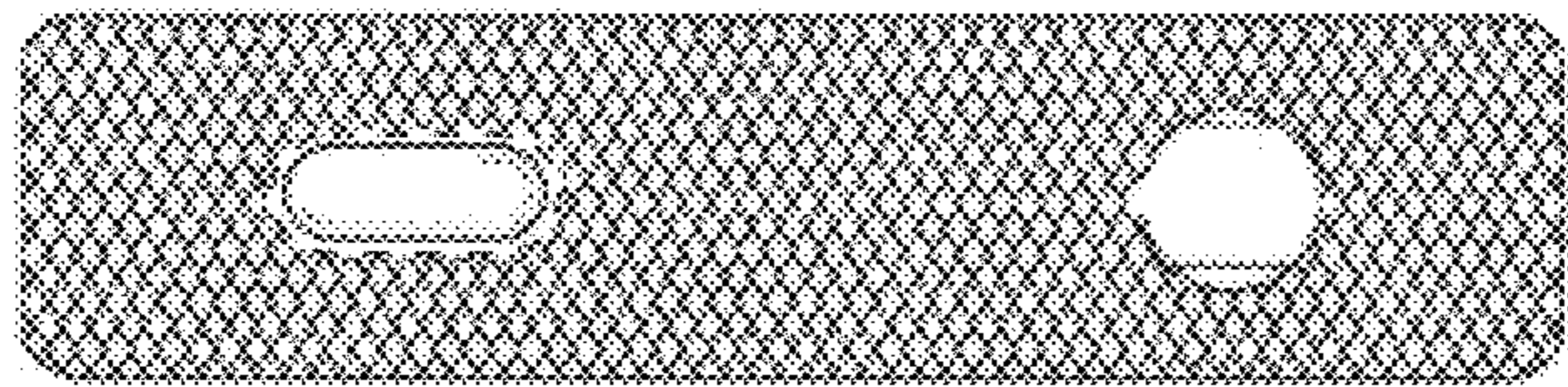

FIG. 7