

US00D690166S

(12) **United States Design Patent**
Montgomery

(10) **Patent No.:** **US D690,166 S**

(45) **Date of Patent:** **** Sep. 24, 2013**

(54) **BOWL WITH UTENSIL RETENTION
FEATURE**

(75) Inventor: **Seana L. Montgomery**, McKinney, TX
(US)

(73) Assignee: **Seana L. Montgomery**, McKinney, TX
(US)

(**) Term: **14 Years**

(21) Appl. No.: **29/428,221**

(22) Filed: **Jul. 27, 2012**

Related U.S. Application Data

(62) Division of application No. 29/369,663, filed on Sep.
10, 2010, now Pat. No. Des. 666,458.

(51) **LOC (9) Cl.** **07-01**

(52) **U.S. Cl.**
USPC **D7/586**

(58) **Field of Classification Search**

USPC D7/505, 500, 587, 586, 506, 538,
D7/555, 541, 546, 548, 553.1, 545, 610, 566,
D7/570; D9/307, 341, 342, 343, 344, 345,
D9/346, 347, 348, 543; 206/561; 220/575
See application file for complete search history.

(56) **References Cited**

U.S. PATENT DOCUMENTS

D109,508 S	5/1938	Wood	
D113,856 S	3/1939	Smith	
2,655,016 A	10/1953	Hudson	
D270,887 S	10/1983	Allgeyer et al.	
D369,727 S *	5/1996	Ancona	D7/691
D391,118 S	2/1998	Jørgensen	
D419,395 S *	1/2000	Swanson	D7/637
D443,181 S	6/2001	Miller	
D455,599 S *	4/2002	Cheng	D7/354
D473,752 S *	4/2003	Kerr	D7/505
D482,575 S	11/2003	Mountain	
D509,994 S	9/2005	Hadland	
D560,434 S	1/2008	Feil	
D564,302 S	3/2008	Freeman	
D590,203 S *	4/2009	Gates	D7/354

D593,807 S	6/2009	Kong	
D603,211 S *	11/2009	Ek	D7/354
D611,769 S *	3/2010	Hauser	D7/584
D627,198 S	11/2010	Hull et al.	
D630,891 S	1/2011	Thonis	
D635,229 S *	3/2011	DuFour	D23/293.1
D639,115 S	6/2011	Stewart et al.	
D656,792 S	4/2012	Sink et al.	
2009/0241347 A1	10/2009	Weaver	
2009/0321455 A1 *	12/2009	Fernandez et al.	220/574

OTHER PUBLICATIONS

U.S. Appl. No. 13/490,364, filed Jun. 6, 2012, entitled "Bowl with Utensil Holder", inventor Seana L. Montgomery.

* cited by examiner

Primary Examiner — Cynthia Underwood

(74) *Attorney, Agent, or Firm* — Patent Capital Group

(57) **CLAIM**

The ornamental design for a bowl with a utensil retention feature, as shown and described.

DESCRIPTION

This Design Application is also related to co-pending U.S. Design patent application Ser. No. 29/428,184, filed on Jul. 27, 2012, entitled Bowl With Utensil Retention Feature; U.S. Design patent application Ser. No. 29/428,185, filed on Jul. 27, 2012, entitled Bowl With Utensil Retention Feature; U.S. Design patent application Ser. No. 29/428,187, filed on Jul. 27, 2012, entitled Bowl With Utensil Retention Feature; U.S. Design patent application Ser. No. 29/428,188, filed on Jul. 27, 2012, entitled Bowl With Utensil Retention Feature; U.S. Design patent application Ser. No. 29/428,189, filed on Jul. 27, 2012, entitled Bowl With Utensil Retention Feature; U.S. Design patent application Ser. No. 29/428,215, filed on Jul. 27, 2012, entitled Bowl With Utensil Retention Feature; U.S. Design patent application Ser. No. 29/428,222, filed on Jul. 27, 2012, entitled Bowl With Utensil Retention Feature; U.S. Design patent application Ser. No. 29/428,225, filed on Jul. 27, 2012, entitled Bowl With Utensil Retention Feature; U.S. Design patent application Ser. No. 29/428,227, filed on Jul. 27, 2012, entitled Bowl With Utensil Retention Feature; U.S. Design patent application Ser. No. 29/428,232, filed on Jul.

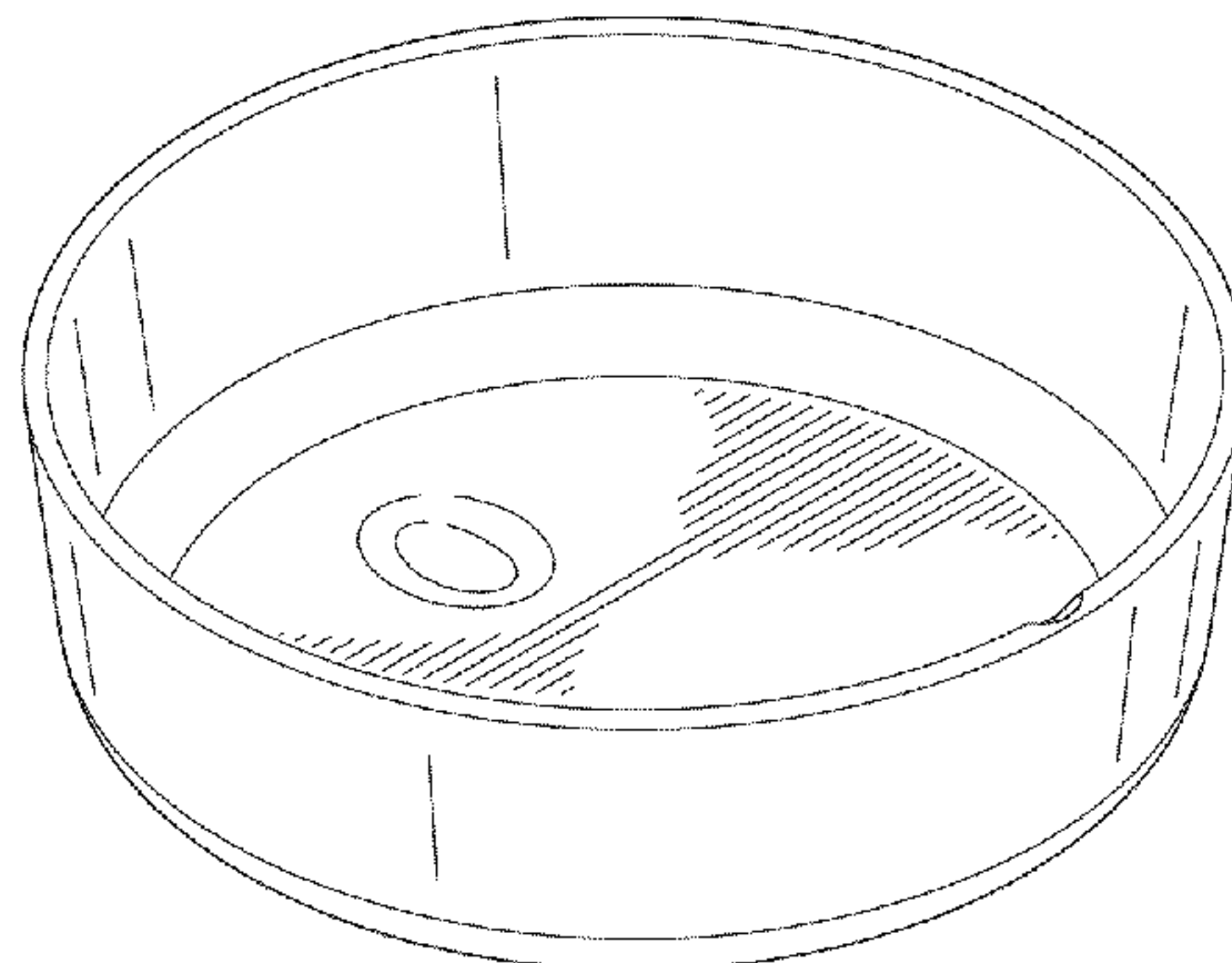

27, 2012, entitled Bowl With Utensil Retention Feature; U.S. Design patent application Ser. No. 29/428,240, filed on Jul. 27, 2012, entitled Bowl With Utensil Retention Feature; U.S. Design patent application Ser. No. 29/428,244, filed on Jul. 27, 2012, entitled Bowl With Utensil Retention Feature; U.S. Design patent application Ser. No. 29/428,248, filed on Jul. 27, 2012, entitled Bowl With Utensil Retention Feature; U.S. Design patent application Ser. No. 29/428,253, filed on Jul. 27, 2012, entitled Bowl With Utensil Retention Feature; U.S. Design patent application Ser. No. 29/428,256, filed on Jul. 27, 2012, entitled Bowl With Utensil Retention Feature; U.S. Design patent application Ser. No. 29/428,261, filed on Jul. 27, 2012, entitled Bowl With Utensil Retention Feature; U.S. Design patent application Ser. No. 29/428,270, filed on Jul. 27, 2012, entitled Bowl With Utensil Retention Feature; U.S. Design patent application Ser. No. 29/428,276, filed on Jul.

27, 2012, entitled Bowl With Utensil Retention Feature; U.S. Design patent application Ser. No. 29/428,279, filed on Jul. 27, 2012, entitled Bowl With Utensil Retention Feature. The disclosure of these Design Applications are considered part of and are incorporated by reference in the disclosure of this design application.

FIG. 1 is a top perspective view showing a bowl with utensil retention feature;

FIG. 2 is a front view of FIG. 1;

FIG. 3 is a back view of FIG. 1;

FIG. 4 is a side view of FIG. 1;

FIG. 5 is another side view of FIG. 1;

FIG. 6 is a top view of FIG. 1; and,

FIG. 7 is a bottom view of FIG. 1.

1 Claim, 2 Drawing Sheets

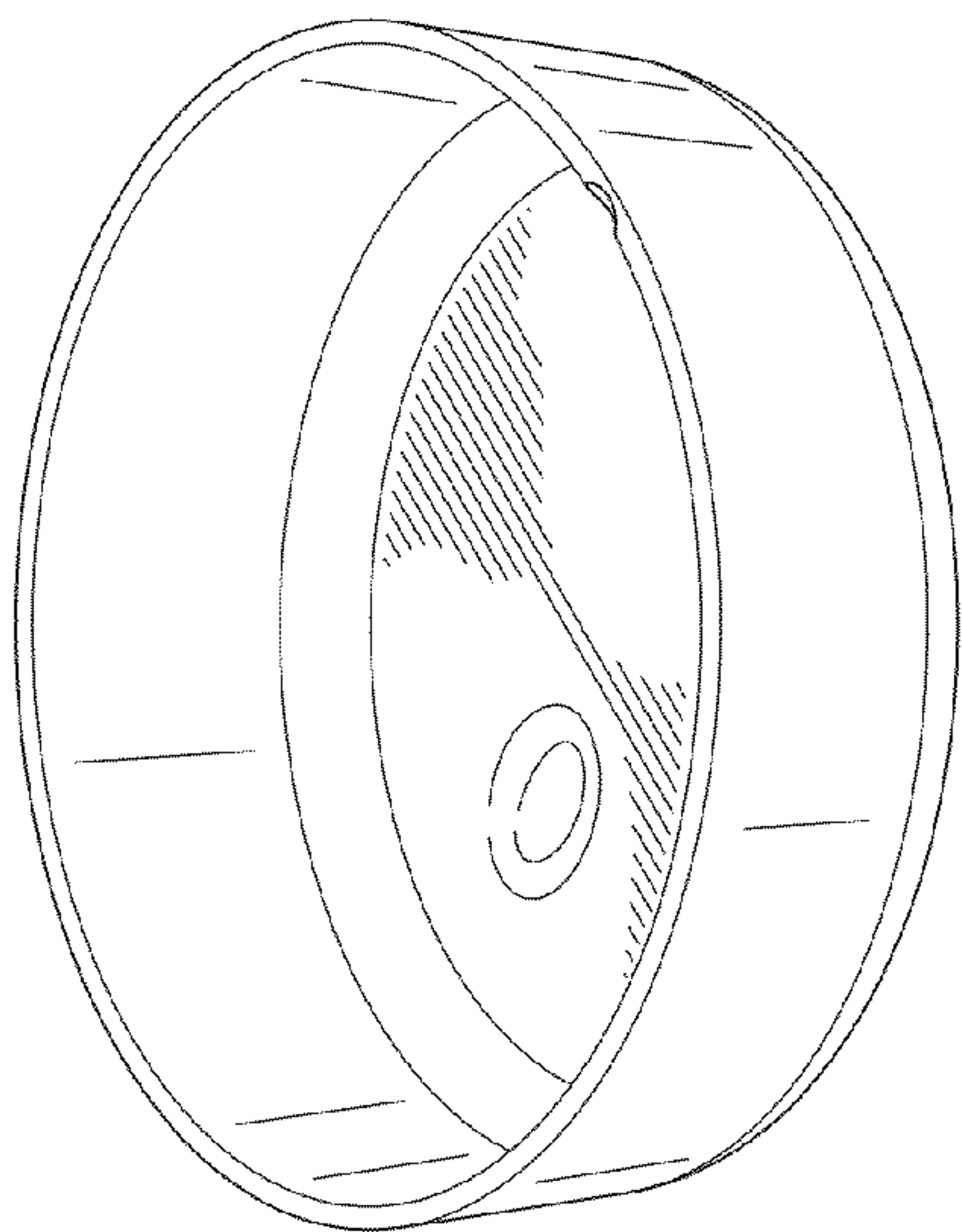

FIG. 1

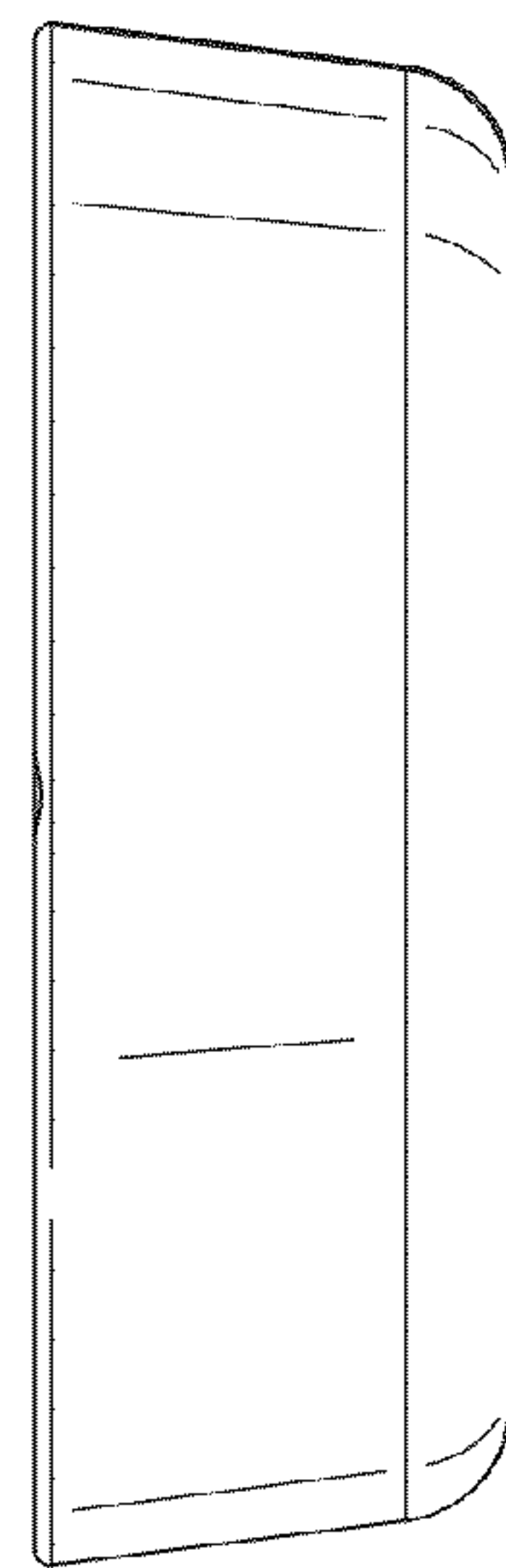

FIG. 2

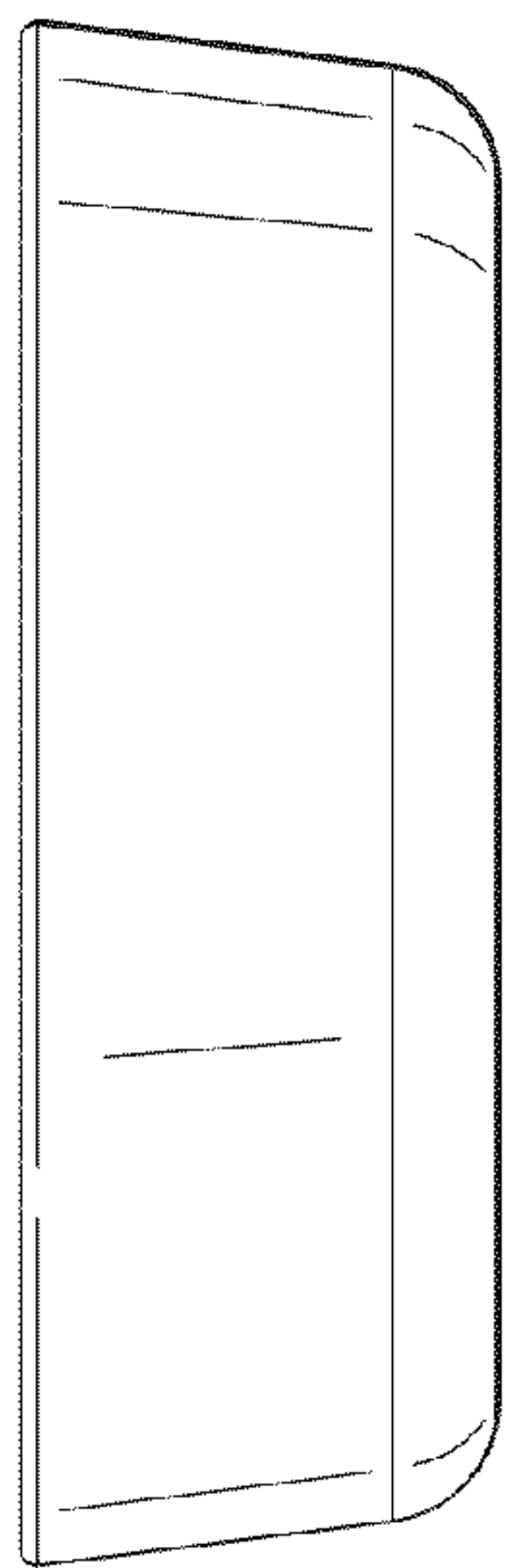

FIG. 3

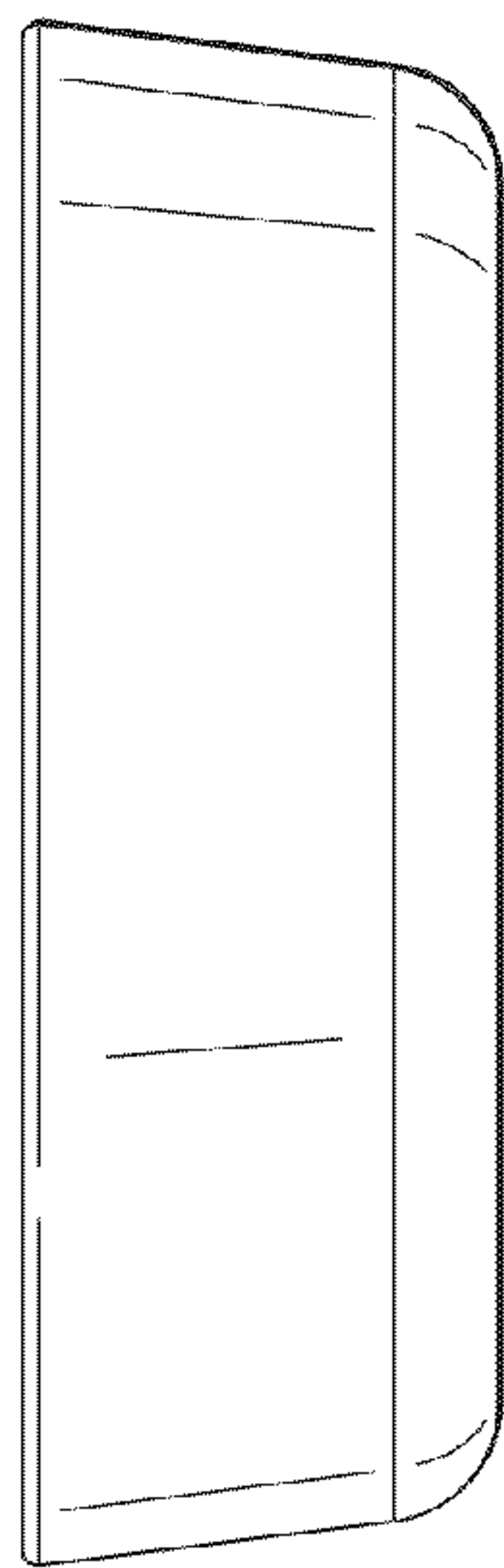

FIG. 4

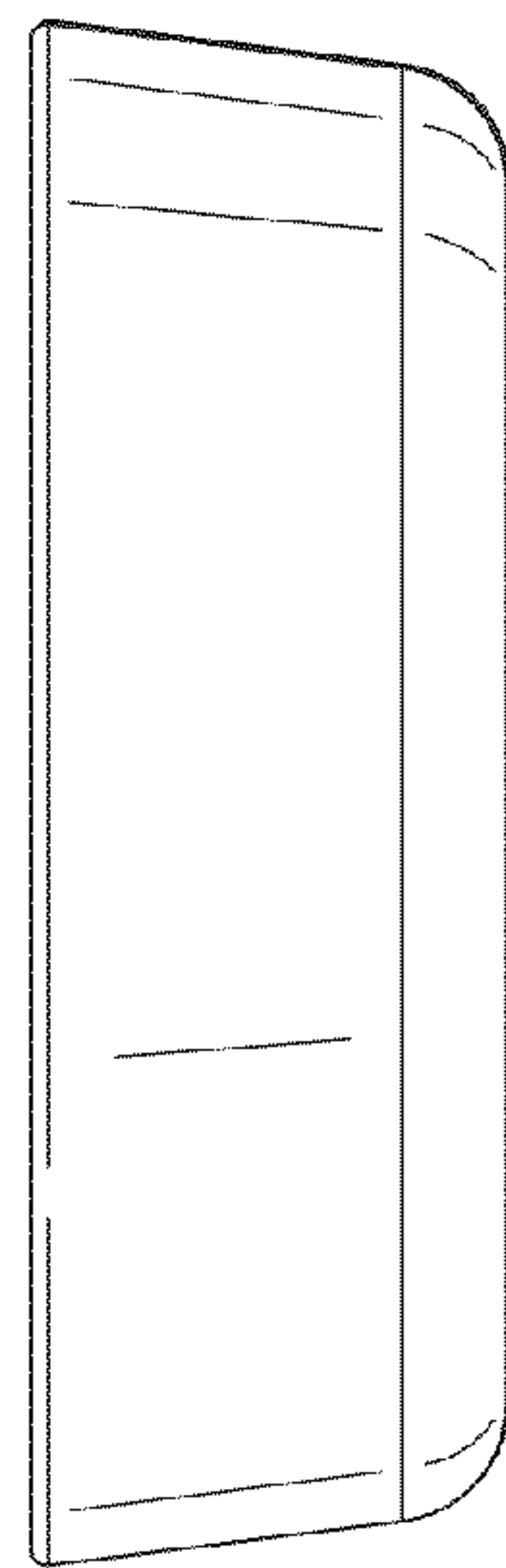

FIG. 5

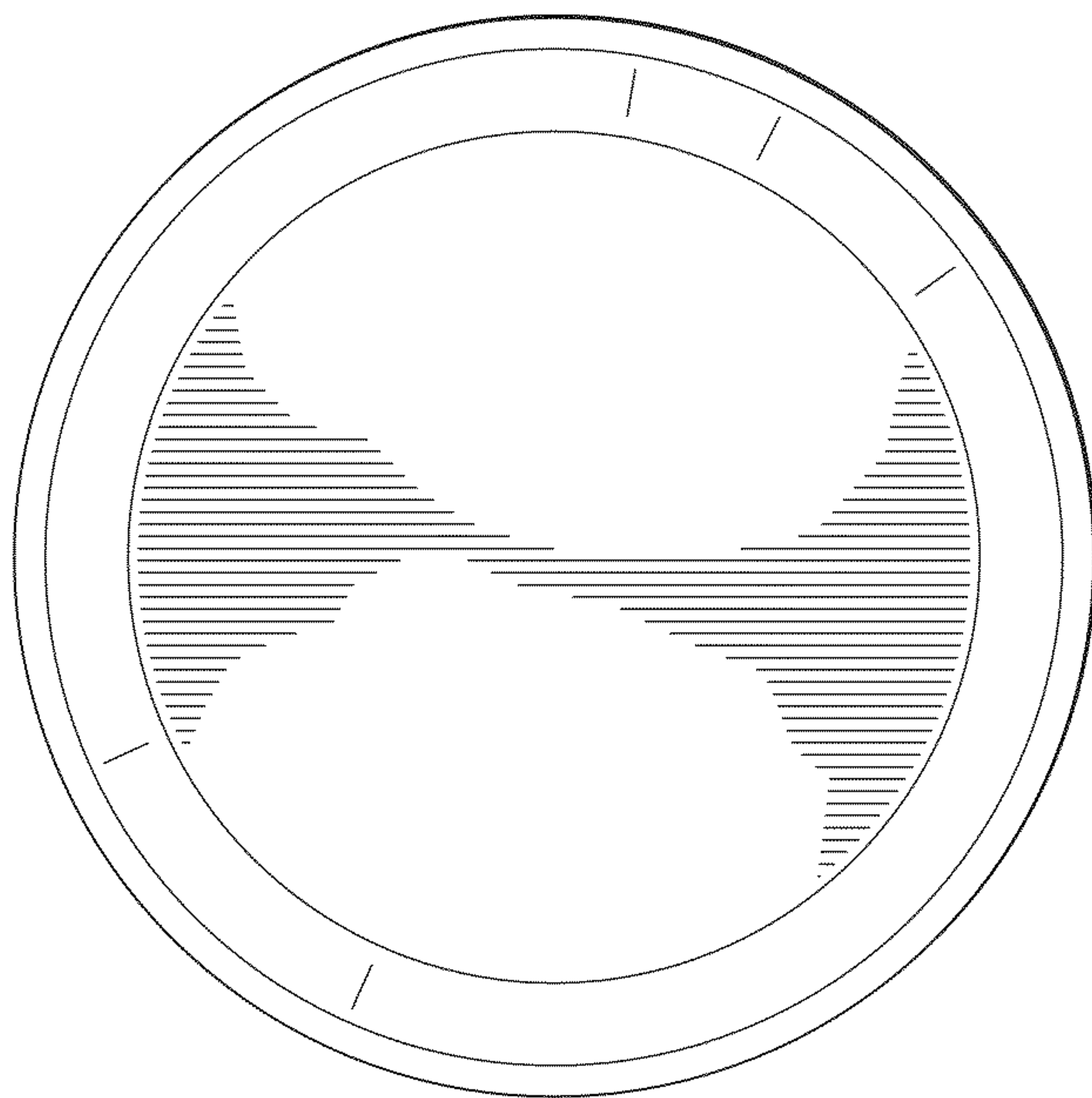

FIG. 7



FIG. 6