



US00D690132S

(12) **United States Design Patent**
Waddick et al.

(10) **Patent No.:** **US D690,132 S**
(45) **Date of Patent:** **** Sep. 24, 2013**

(54) **COMBINED PIN-HOLE LIQUID DISPENSER AND CAP, AND HOLDER THEREFOR**

DESCRIPTION

(76) Inventors: **James F. Waddick**, Palos Hills, IL (US);
Kevin Condon, Tinley Park, IL (US);
Rao K. Murukurthy, Schiller Park, IL (US)

(**) Term: **14 Years**

(21) Appl. No.: **29/415,934**

(22) Filed: **Mar. 15, 2012**

(51) **LOC (9) Cl.** **23-02**

(52) **U.S. Cl.**
USPC **D6/545**

(58) **Field of Classification Search**
USPC D6/515–523, 545; 206/225, 233,
206/389, 391; 211/13.1, 45; 242/570, 590;
221/26, 33, 282–283; 222/173, 180;
248/309.1, 309.2, 905; D10/74, 103, 122
See application file for complete search history.

(56) **References Cited**

U.S. PATENT DOCUMENTS

D244,929 S	7/1977	Armstrong	
D247,347 S	2/1978	Klingaman	
D253,394 S	11/1979	Berghahn et al.	
D253,579 S	12/1979	Sinclair	
D254,838 S	4/1980	Agnone et al.	
D255,990 S	7/1980	Lucas	
D256,775 S	9/1980	Voitl	
6,345,723 B1 *	2/2002	Blake et al.	D6/545
D563,133 S *	3/2008	Kramer	D6/545
D569,669 S *	5/2008	Nichols et al.	D6/545

* cited by examiner

Primary Examiner — Brian N Vinson

(74) *Attorney, Agent, or Firm* — Amin Talati, LLC; George M. Carrera, Jr.; Brian M. Wishnow

(57) **CLAIM**

The ornamental design for a combined pin-hole liquid dispenser and cap, and holder therefor, as shown and described.

A combined pin-hole liquid dispenser and holder, for dispensing a liquid hand sanitizer through a bottom-facing pin-hole aperture, is provided. The malleable dispenser is detachable from the holder or may be seated in the holder. The pin-hole dispenser is also combined with a cap.

FIG. 1 is a perspective view of a combined pin-hole liquid dispenser and cap, and holder therefor showing my new design in an upright position;

FIG. 2 is a perspective view of the combined pin-hole liquid dispenser and cap, and holder therefor viewed from below;

FIG. 3 is a front elevation view of the combined pin-hole liquid dispenser and cap, and holder therefor;

FIG. 4 is a rear elevation view thereof;

FIG. 5 is a left side view thereof;

FIG. 6 is a right side view thereof;

FIG. 7 is a top plan view thereof;

FIG. 8 is a bottom plan view thereof;

FIG. 9 is a perspective view of the combined pin-hole liquid dispenser and cap, and holder therefor of FIG. 1 in a detached condition, wherein a combined pin-hole liquid dispenser and cap, and a holder, are detached one from another;

FIG. 10 is a perspective view of the combined pin-hole liquid dispenser and cap, and holder therefor of FIG. 2 in a detached condition, wherein a combined pin-hole liquid dispenser and cap, and a holder, are detached one from another;

FIG. 11 is right side view of the combined pin-hole liquid dispenser and cap, and holder therefor of FIG. 6 in a detached condition, wherein a combined pin-hole liquid dispenser and cap, and a holder, are detached one from another; and,

FIG. 12 is a rear perspective view of the combined pin-hole liquid dispenser and cap, and holder therefor in a detached condition, wherein a combined pin-hole liquid dispenser and cap, and a holder, are detached one from another. The broken line portions of the disclosure are for illustrative purposes only and form no part of the claimed design.

1 Claim, 11 Drawing Sheets

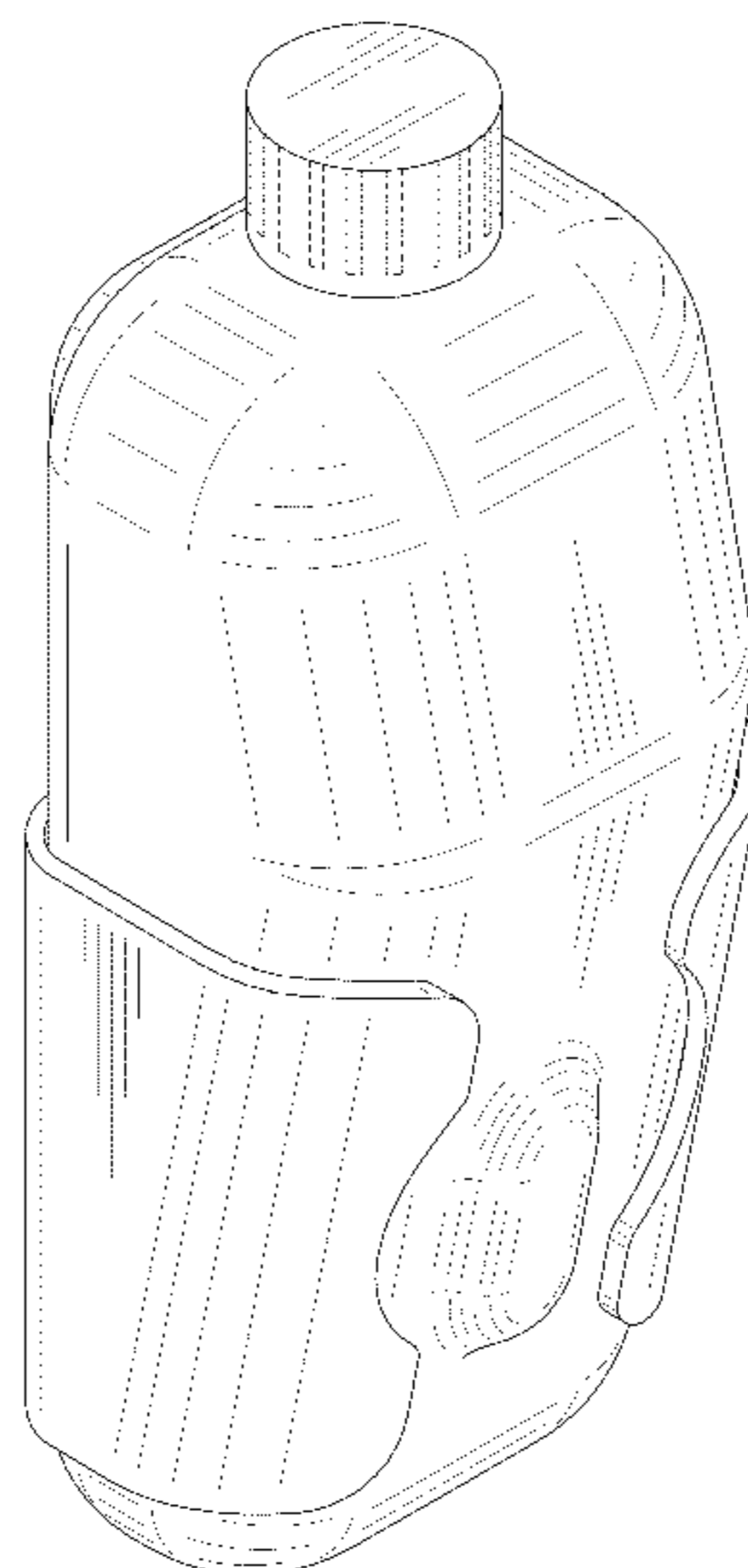

FIG. 1

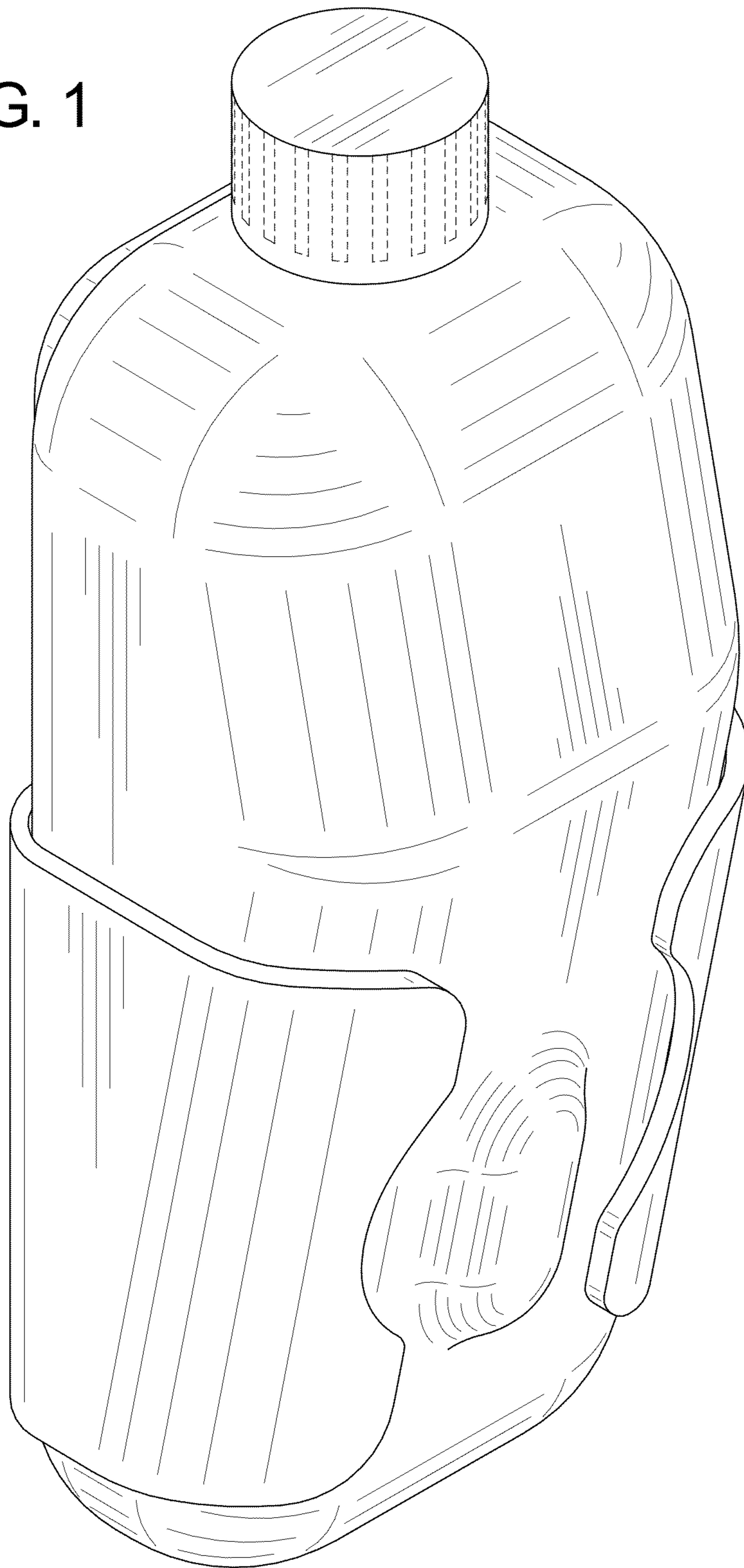

FIG. 2



FIG. 3

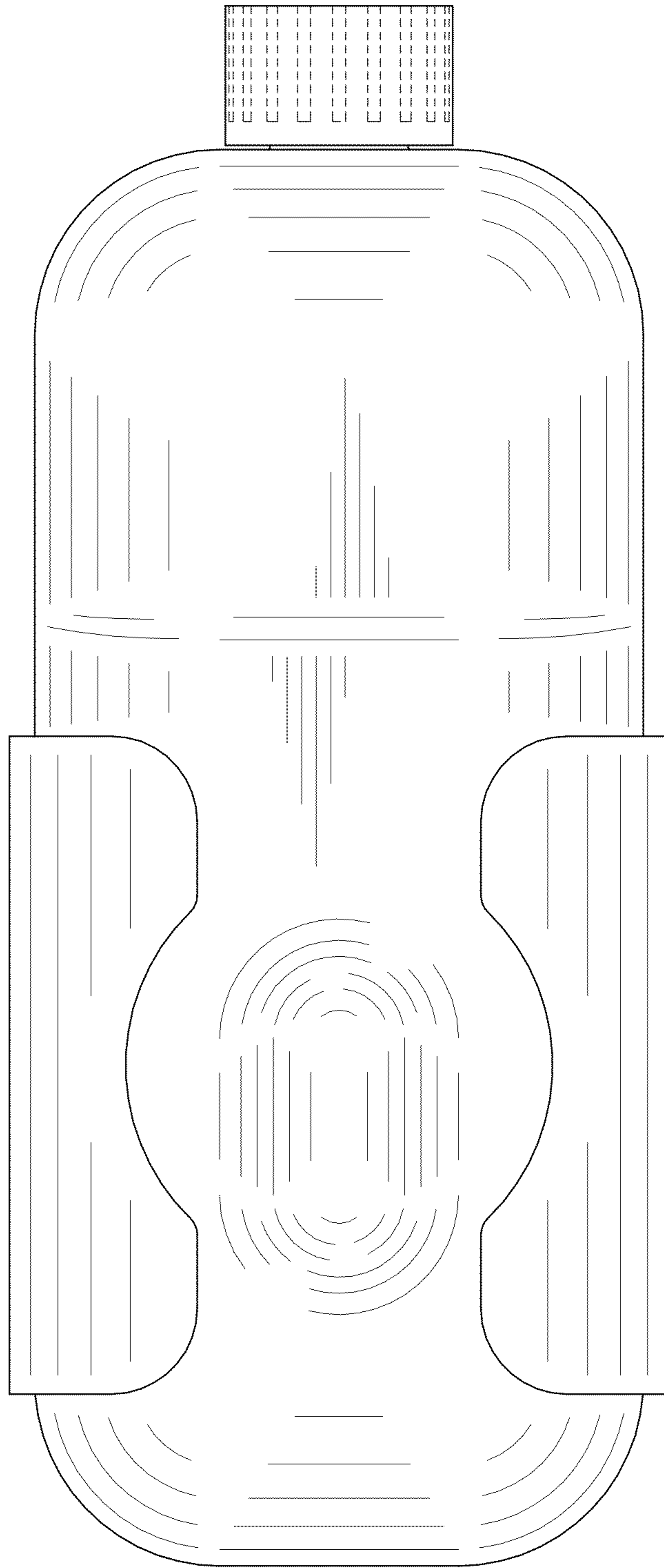

FIG. 4

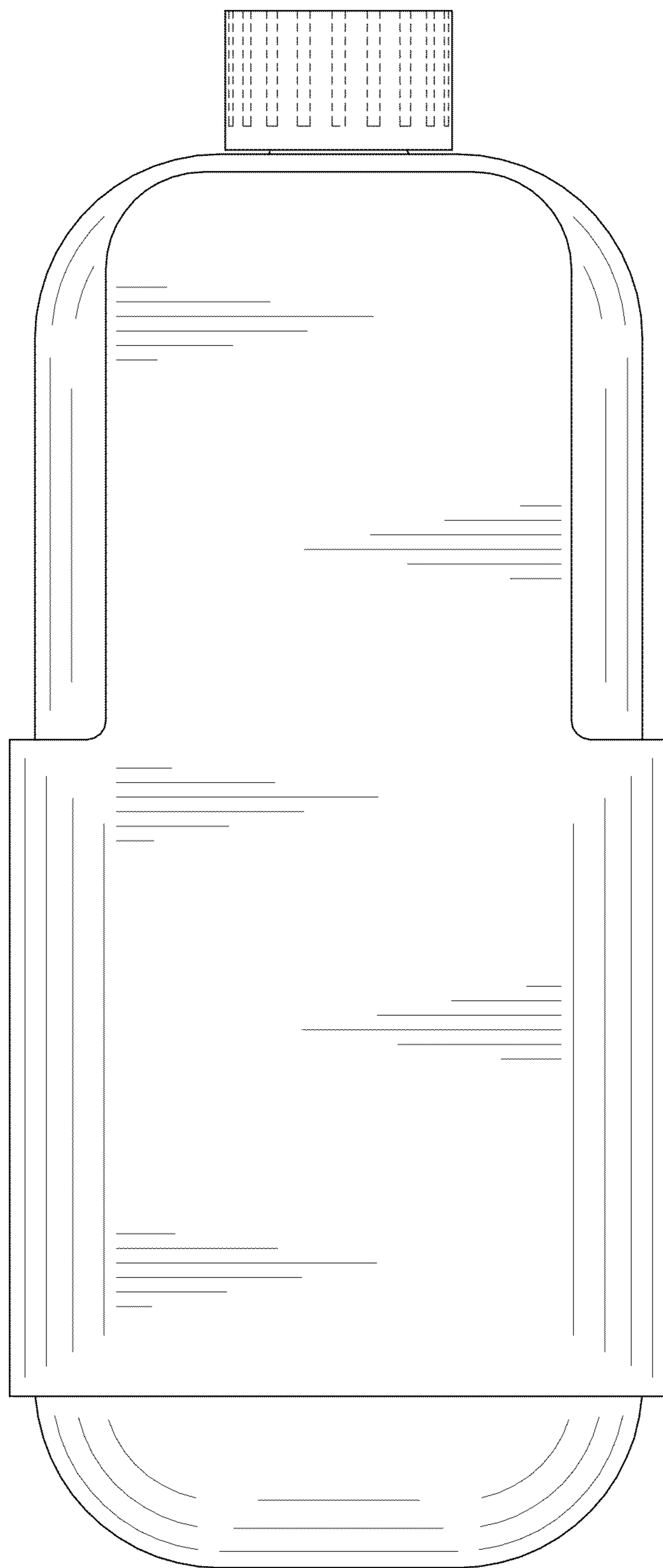

FIG. 5

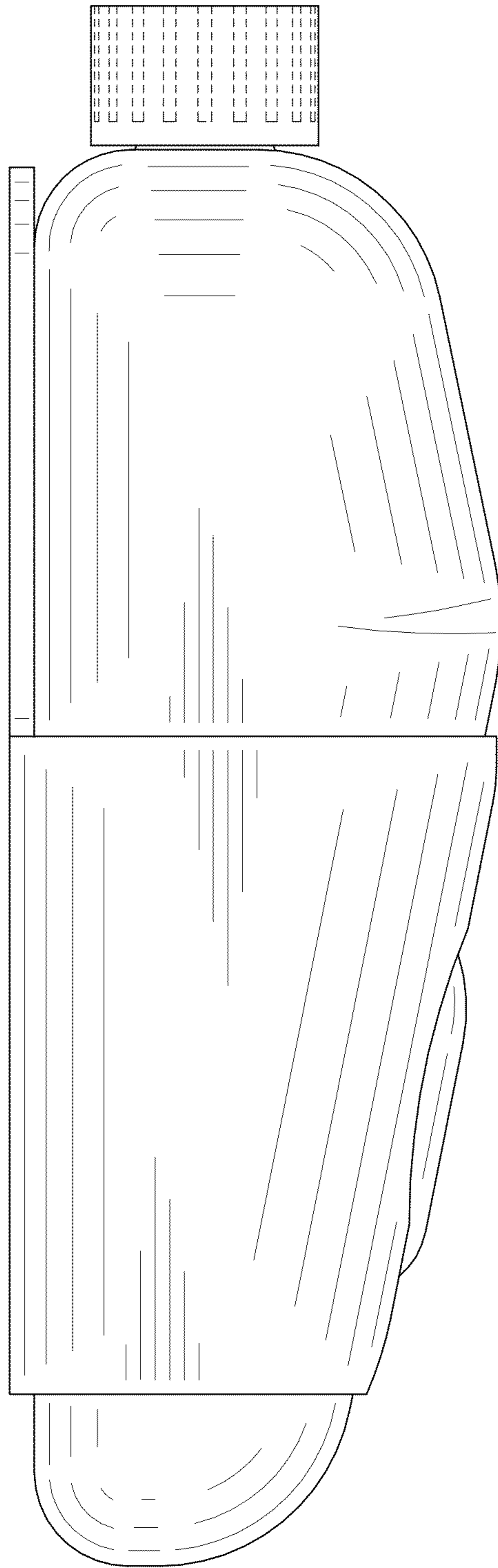

FIG. 6

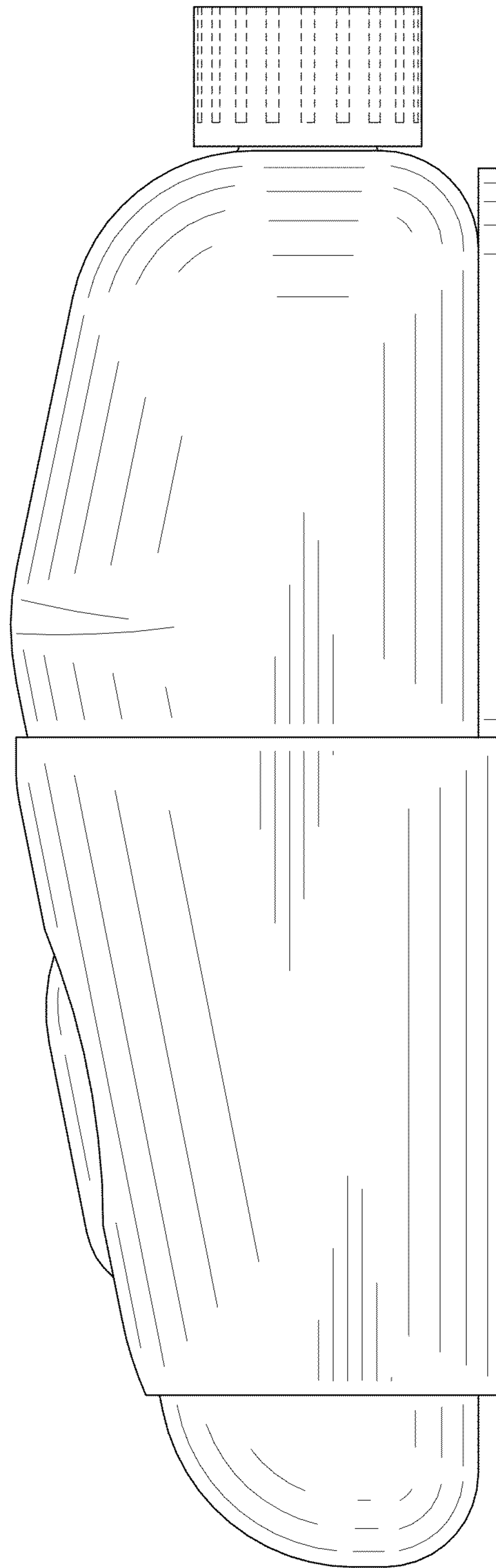

FIG. 7

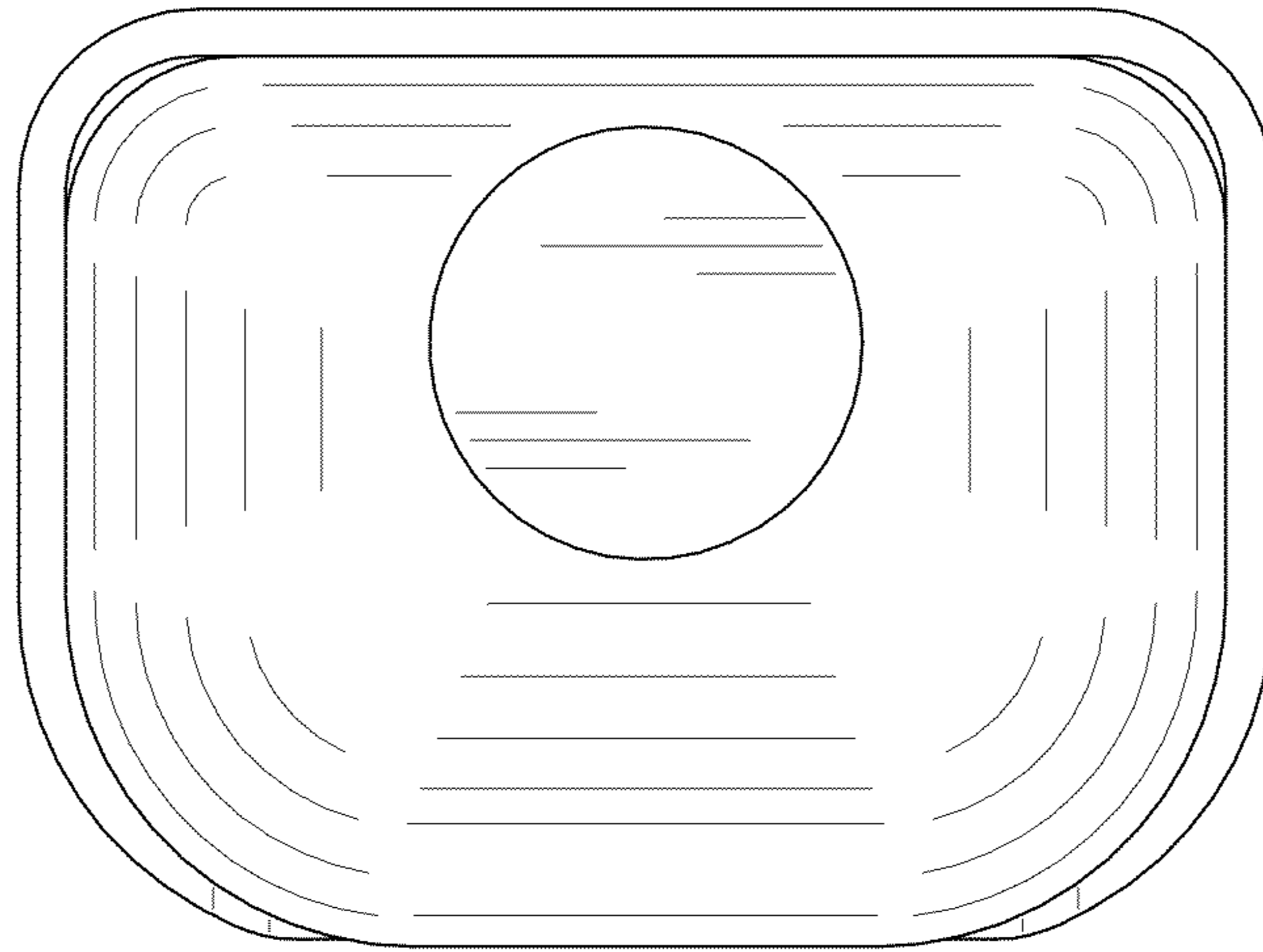

FIG. 8

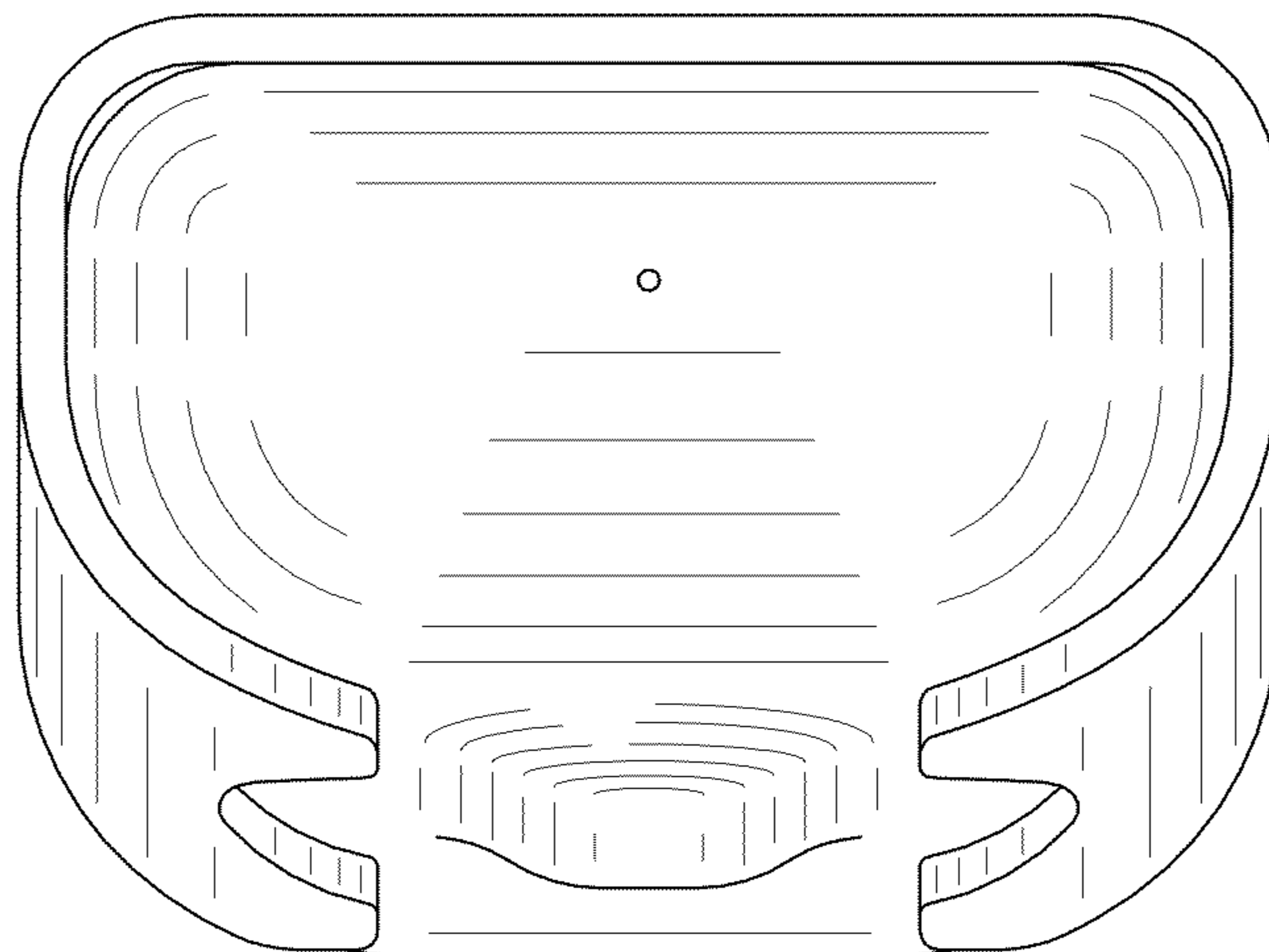
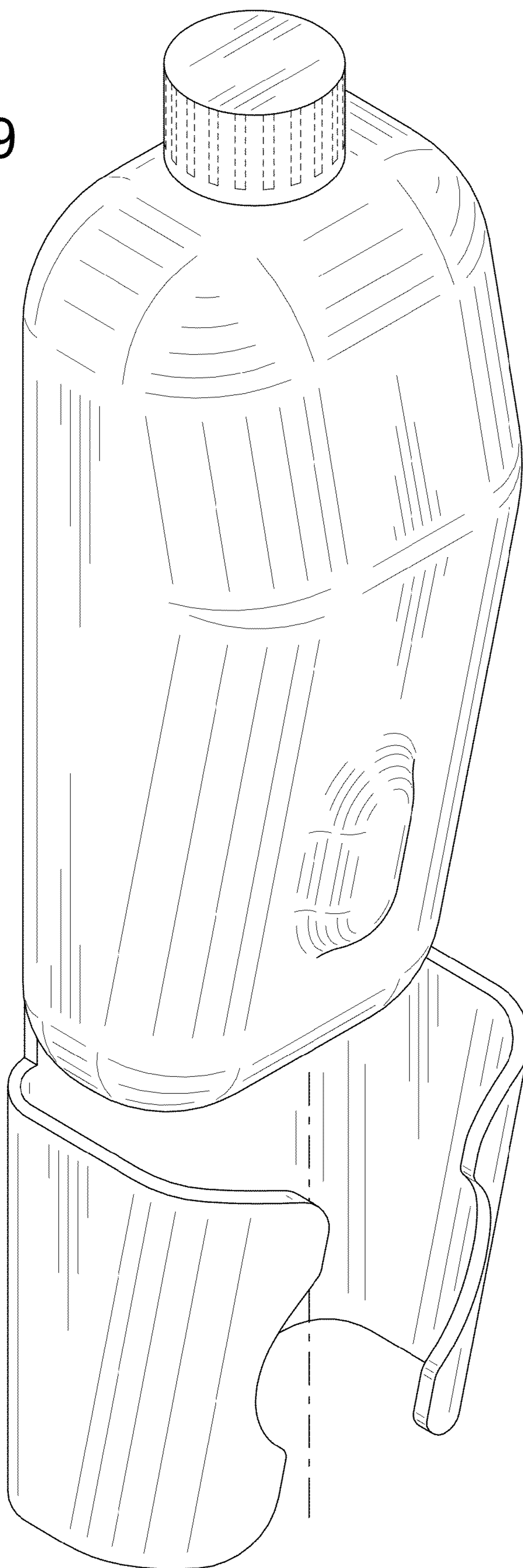

FIG. 9



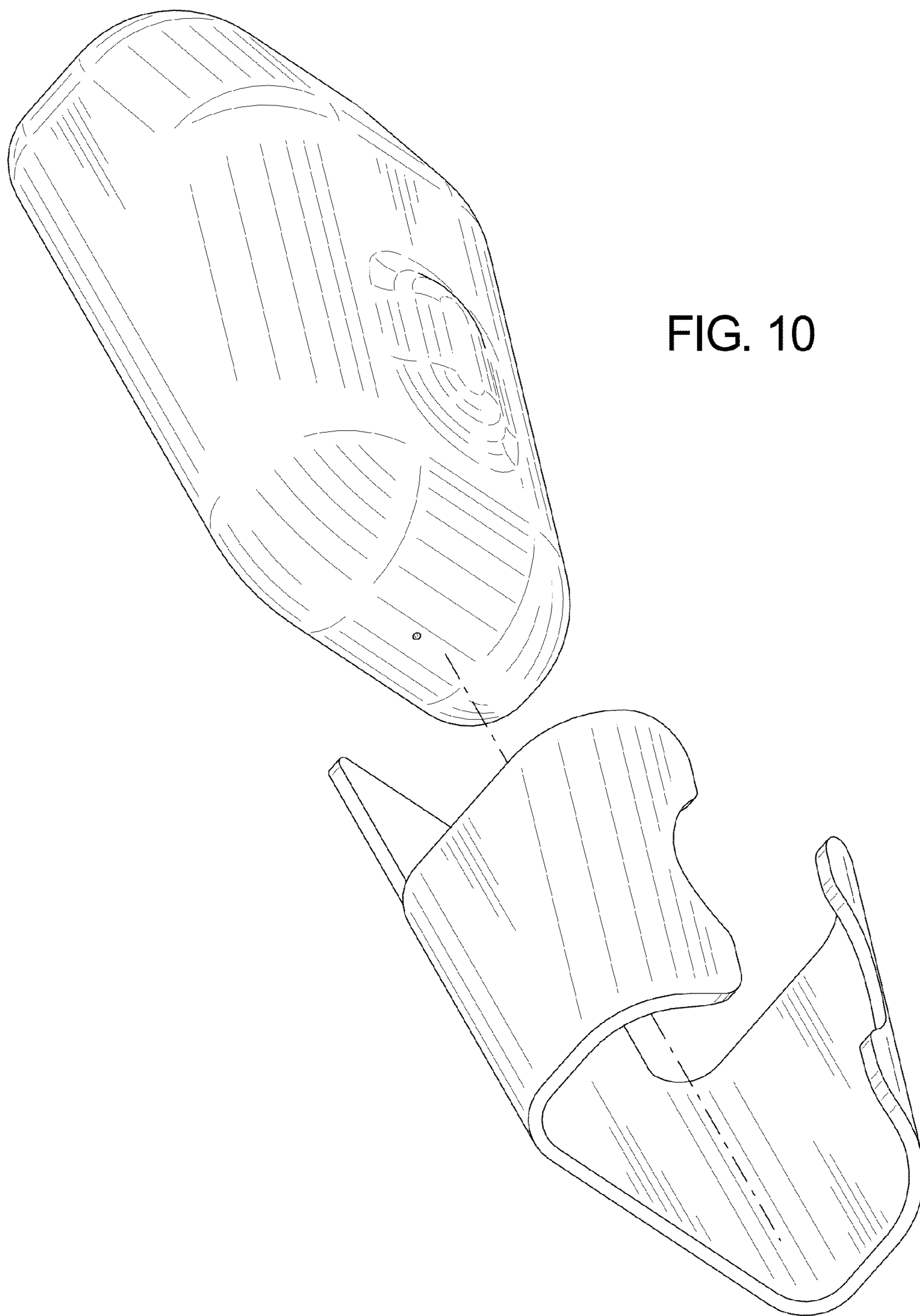

FIG. 10

FIG. 11

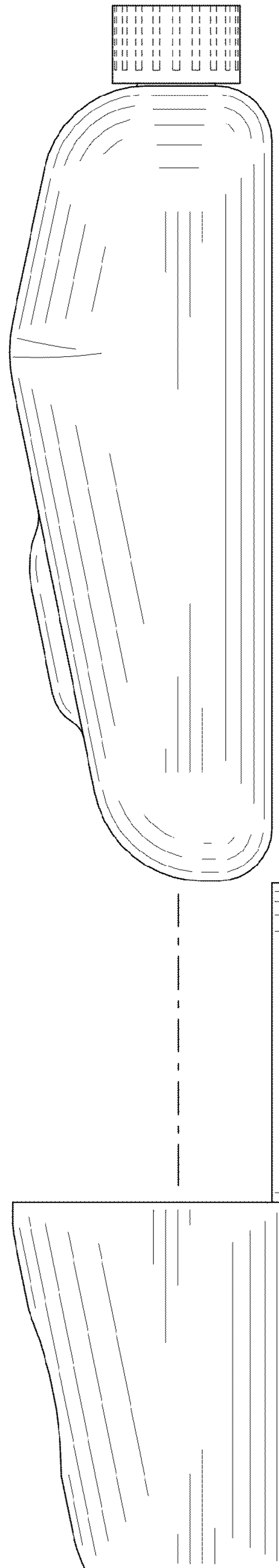

FIG. 12

