



US00D68998S

(12) **United States Design Patent**  
**Carbone et al.**

(10) **Patent No.:** **US D689,998 S**

(45) **Date of Patent:** **\*\* Sep. 17, 2013**

(54) **DISPENSER HOUSING**

5,547,721 A 8/1996 Kuo  
D392,032 S 3/1998 Zaragoza et al.  
D393,202 S 4/1998 Bertolini et al.

(75) Inventors: **Gabriele Carbone**, Lausanne (CH);  
**Khodayar Feiz**, Amsterdam (NL);  
**Claudia V. Gamboa**, Chicago, IL (US);  
**Jonathan N. Mandell**, Gurnee, IL (US)

(Continued)

**FOREIGN PATENT DOCUMENTS**

(73) Assignee: **S.C. Johnson & Son, Inc.**, Racine, WI  
(US)

AU 127544 S 8/1996  
AU 140650 S 5/2000

(Continued)

**OTHER PUBLICATIONS**

(\*\*) Term: **14 Years**

Personalized Engraved Gifts product page for a Sky Blue Ariana Vase  
[online] [retrieved on Mar. 29, 2013], 1 page. Retrieved from <<http://www.personalized-engraved-gifts.com/products/707>>.

(21) Appl. No.: **29/430,188**

(Continued)

(22) Filed: **Aug. 22, 2012**

(51) **LOC (9) Cl.** ..... **28-99**

(52) **U.S. Cl.**  
USPC ..... **D23/366**

(58) **Field of Classification Search**  
USPC ..... D23/355-369; D28/5, 6; 261/DIG. 17,  
261/DIG. 42, DIG. 65, DIG. 88, DIG. 89,  
261/DIG. 47, DIG. 55, DIG. 70; 392/356,  
392/390, 392, 394, 395; 239/34, 44, 53,  
239/55, 56, 326, 60, 308; D9/687; D7/591  
See application file for complete search history.

*Primary Examiner* — Sandra Snapp

(74) *Attorney, Agent, or Firm* — Quarles & Brady, LLP

(57) **CLAIM**

The ornamental design for a dispenser housing, as shown and described.

**DESCRIPTION**

FIG. 1 is an isometric view of a top, front, and left side of an ornamental design for a dispenser housing;  
FIG. 2 is a front elevational view of the housing of FIG. 1;  
FIG. 3 is a rear elevational view of the housing of FIG. 1;  
FIG. 4 is a left side elevational view of the housing of FIG. 1;  
FIG. 5 is a right side elevational view of the housing of FIG. 1;  
FIG. 6 is a top plan view of the housing of FIG. 1; and,  
FIG. 7 is a bottom plan view of the housing of FIG. 1.  
The dash-dash-dash-dash broken lines are for the purpose of illustrating environmental structure and forms no part of the claimed design.

(56) **References Cited**

**U.S. PATENT DOCUMENTS**

D172,850 S 8/1954 Van Koert  
D172,852 S 8/1954 Van Koert  
D196,455 S 10/1963 Stern  
D204,707 S 5/1966 Abbott  
D345,848 S 4/1994 May et al.  
5,353,546 A 10/1994 Bock  
D357,085 S 4/1995 Ratia  
D362,646 S 9/1995 Rahr  
D362,647 S 9/1995 Rahr  
D364,990 S 12/1995 Fonville

**1 Claim, 6 Drawing Sheets**

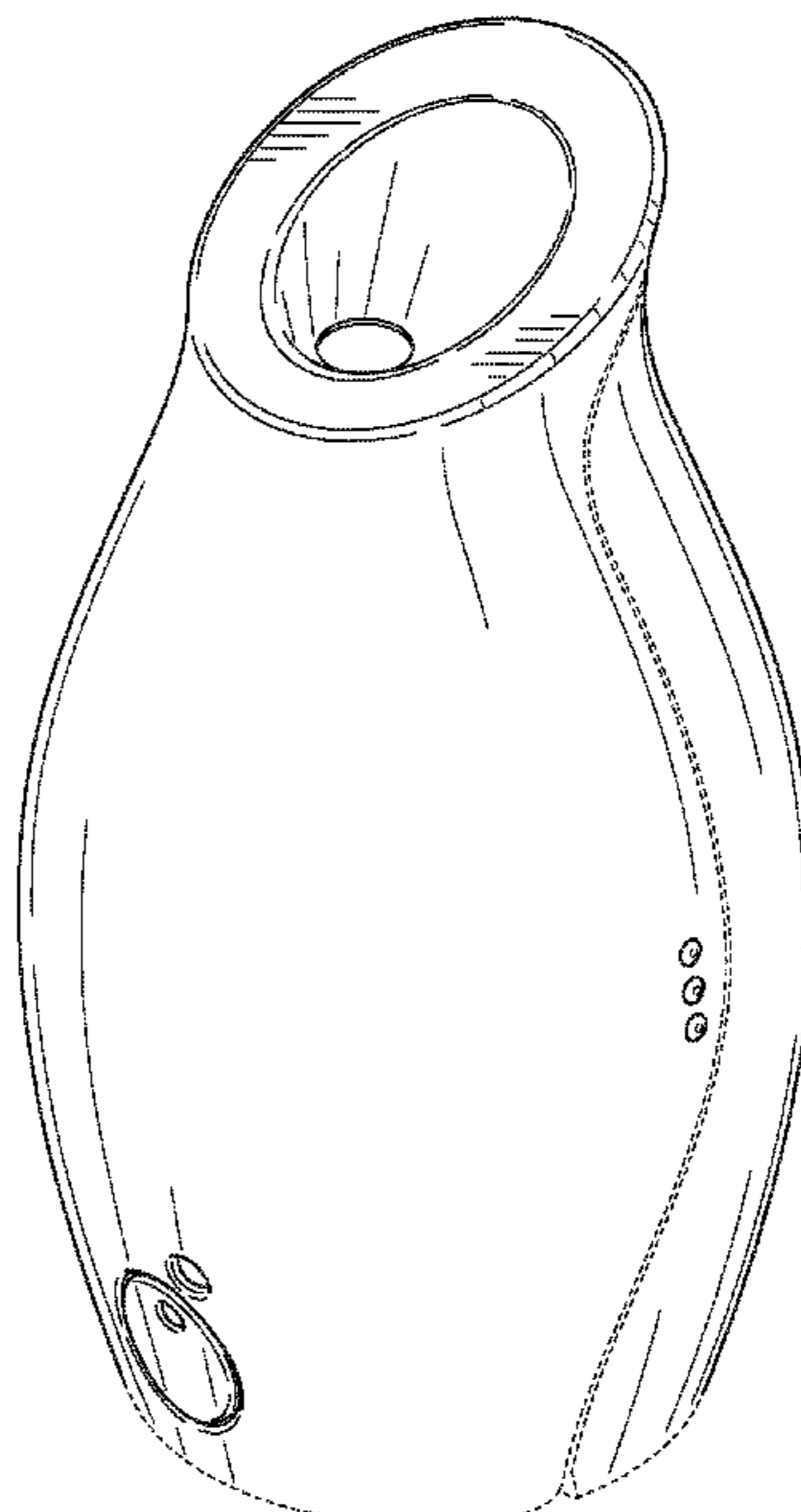

(56)

References Cited

U.S. PATENT DOCUMENTS

D400,800 S 11/1998 Bertolini et al.  
 D404,312 S 1/1999 Granai  
 D405,357 S 2/1999 Sell  
 D410,096 S 5/1999 Majerowski  
 D411,740 S 6/1999 Kim  
 D424,471 S 5/2000 Souris  
 D425,220 S 5/2000 Klett et al.  
 D427,513 S 7/2000 Boisset  
 D428,573 S 7/2000 Colonna et al.  
 D430,658 S 9/2000 Farce  
 D434,667 S 12/2000 Gobe  
 D437,744 S 2/2001 Young et al.  
 D440,824 S 4/2001 Carter et al.  
 D440,825 S 4/2001 Carter et al.  
 D447,256 S 8/2001 Ratia  
 D448,620 S 10/2001 Neal  
 D448,909 S 10/2001 Friesen et al.  
 D450,395 S 11/2001 Bellenger  
 D451,012 S 11/2001 Billy  
 D451,379 S 12/2001 Tang  
 D454,190 S 3/2002 Trocola  
 6,419,122 B1 7/2002 Chown  
 D470,971 S 2/2003 Vegliante  
 D472,148 S 3/2003 Dowd  
 D477,066 S 7/2003 Lonczak et al.  
 D477,535 S 7/2003 Thorpe  
 D478,778 S 8/2003 Jarvis et al.  
 D479,134 S 9/2003 Murata  
 D486,389 S 2/2004 Yourist  
 D488,060 S 4/2004 Yourist  
 D496,451 S 9/2004 Julos et al.  
 D498,145 S 11/2004 McLeish  
 D498,422 S 11/2004 Theunynck  
 D498,970 S 11/2004 Huang  
 D502,110 S 2/2005 Theunynck  
 D509,894 S 9/2005 Hoyt et al.  
 D510,134 S 9/2005 Lablaine  
 D510,272 S 10/2005 Duboeuf et al.  
 D512,938 S 12/2005 Morris et al.  
 D513,479 S 1/2006 Behrens  
 D515,432 S 2/2006 Tabibi  
 D515,927 S 2/2006 Smay et al.  
 D516,692 S 3/2006 Caserta et al.  
 D519,376 S 4/2006 Ames  
 D525,131 S 7/2006 Davies et al.  
 D525,531 S 7/2006 Bansal  
 D531,042 S 10/2006 Venkataraman et al.  
 D535,004 S 1/2007 Furner et al.  
 D535,376 S 1/2007 Michaels et al.  
 D535,377 S 1/2007 Caserta et al.  
 D535,378 S 1/2007 Caserta et al.  
 D537,362 S 2/2007 Ivankovic  
 D538,668 S 3/2007 Campbell et al.  
 D538,915 S 3/2007 Anderson et al.  
 D539,149 S 3/2007 Koskinen  
 D539,892 S 4/2007 Caserta et al.  
 D539,972 S 4/2007 Layne  
 D539,973 S 4/2007 Layne  
 D541,168 S 4/2007 Duboeuf et al.  
 D542,707 S 5/2007 Kolokotronis et al.  
 D544,084 S 6/2007 Michaels et al.  
 D544,593 S \* 6/2007 Yamamoto ..... D23/366  
 D547,198 S 7/2007 Eaton et al.  
 D547,670 S 7/2007 Heisner  
 D547,850 S 7/2007 Michaels et al.  
 D548,317 S \* 8/2007 Newton et al. .... D23/366  
 D556,043 S 11/2007 Rabie  
 D556,626 S 12/2007 Shaffer et al.  
 D559,434 S \* 1/2008 Morris et al. .... D26/128  
 D560,017 S 1/2008 Morris et al.  
 D560,018 S 1/2008 Morris et al.  
 D560,508 S 1/2008 Lepoitevin  
 D561,318 S 2/2008 Naksen et al.  
 D561,884 S 2/2008 Furner et al.  
 D561,885 S 2/2008 Furner et al.

D561,886 S 2/2008 Furner et al.  
 D567,475 S 4/2008 West  
 RE40,392 E 6/2008 Rymer et al.  
 D571,222 S 6/2008 Duboeuf et al.  
 D572,860 S 7/2008 Demarest et al.  
 D574,199 S 8/2008 Griffith et al.  
 D575,103 S 8/2008 Gluck  
 D576,039 S 9/2008 Bradley et al.  
 D578,009 S 10/2008 Bourne  
 D581,035 S 11/2008 Conway et al.  
 D581,279 S 11/2008 Oates  
 D582,063 S 12/2008 Spangler et al.  
 D582,278 S 12/2008 Bourne  
 D582,537 S 12/2008 Kay et al.  
 D582,580 S 12/2008 Spangler et al.  
 D583,038 S 12/2008 Kay et al.  
 D583,039 S 12/2008 Kay et al.  
 D583,453 S 12/2008 Kay et al.  
 D583,454 S 12/2008 Kay et al.  
 D583,455 S 12/2008 Kay et al.  
 D583,457 S 12/2008 Kay et al.  
 D586,605 S 2/2009 Ma et al.  
 D586,606 S 2/2009 Ma et al.  
 D587,127 S 2/2009 Moreira et al.  
 D588,687 S 3/2009 Drucker et al.  
 D591,110 S 4/2009 Koehler  
 D595,090 S 6/2009 Benson  
 D595,540 S 7/2009 Pickering et al.  
 D595,829 S 7/2009 Drucker et al.  
 D597,192 S \* 7/2009 Drucker et al. .... D23/366  
 D597,413 S 8/2009 Teuscher  
 D604,622 S 11/2009 Bohache et al.  
 D607,553 S 1/2010 Roller  
 D607,734 S 1/2010 Kuzma et al.  
 D607,735 S 1/2010 Kuzma et al.  
 D608,436 S 1/2010 Drucker et al.  
 D609,096 S 2/2010 Floyd  
 D610,910 S 3/2010 Simmons et al.  
 D610,915 S 3/2010 Conway et al.  
 D611,348 S 3/2010 Handy  
 D611,833 S 3/2010 Taylor et al.  
 D613,844 S 4/2010 Jorgensen  
 D614,277 S 4/2010 Hsiao  
 D616,762 S 6/2010 Caldwell et al.  
 D623,070 S 9/2010 Jamison et al.  
 D624,818 S 10/2010 Lepoitevin  
 D624,826 S 10/2010 Lepoitevin  
 D627,662 S 11/2010 Darr et al.  
 D629,880 S 12/2010 Hisey  
 D632,771 S \* 2/2011 Abbondanzio et al. .... D23/366  
 D632,772 S \* 2/2011 Abbondanzio et al. .... D23/366  
 D632,773 S \* 2/2011 Abbondanzio et al. .... D23/366  
 D633,190 S \* 2/2011 Abbondanzio et al. .... D23/366  
 D635,653 S 4/2011 Conway et al.  
 D637,274 S 5/2011 Chan et al.  
 D640,927 S 7/2011 Seum et al.  
 D643,737 S 8/2011 Handy  
 D644,880 S 9/2011 Li  
 D646,768 S 10/2011 Chan et al.  
 D647,187 S \* 10/2011 Chan et al. .... D23/364  
 D653,892 S 2/2012 Felduto et al.  
 D653,989 S 2/2012 Falduto et al.  
 D654,761 S 2/2012 Herbst  
 D657,570 S 4/2012 Mahiques  
 D659,012 S 5/2012 Subler  
 D660,195 S 5/2012 Harshman  
 D674,886 S 1/2013 Irwin et al.  
 D679,793 S 4/2013 Feiz et al.  
 2007/0204511 A1 9/2007 Lee et al.  
 2008/0279731 A1 11/2008 Goreham et al.

FOREIGN PATENT DOCUMENTS

AU 304152 S 11/2005  
 AU 307763 S 7/2006  
 AU 307764 S 7/2006  
 AU 311318 S 11/2006  
 AU 329382 S 1/2010  
 AU 329383 S 1/2010  
 AU 330784 S 5/2010

# US D689,998 S

Page 3

AU	330785	S	5/2010	EM	000904800003	10/2009
AU	330786	S	5/2010	EM	0016517460001	1/2010
AU	330787	S	5/2010	EM	0001189740-0001 A1	3/2010
AU	330788	S	5/2010	EM	0011897400003	3/2010
AU	342910	S	6/2012	EM	0011716560003	7/2010
CA	124156		1/2008	EM	0011716560004	7/2010
CN	200930086662.5		6/2010	EM	0017424200001	10/2010
CN	200930082557.4		7/2010	EM	001825944-0007 A1	3/2011
CN	200930273309.8		7/2010	EM	0018259440010 A1	3/2011
CN	200930383924.4		7/2010	EM	0019579860001	1/2012
CN	200930342489.0		8/2010	EM	0020154950002	3/2012
CN	200930290969.7		9/2010	EM	0013219620022 A1	4/2012
CN	201030103862.X		9/2010	EM	0020514170001	6/2012
CN	201030109104.9		9/2010	FR	003646	10/2000
CN	201030100217.2		10/2010	FR	052778	8/2005
CN	201030138857.2		10/2010	FR	093275	7/2010
CN	201030143618.6		10/2010	GB	2054115 A	2/1981
CN	200930382824.X		11/2010	GB	1058785	4/1989
CN	200930680610.0		11/2010	GB	2058321	8/1996
CN	201030138853.4		11/2010	GB	2080588	1/1999
CN	201030171816.3		11/2010	GB	2082970	4/1999
CN	201030184791.0		11/2010	GB	2088735	6/1999
CN	201030226501.4		11/2010	GB	2085750	10/1999
CN	201030148641.4		12/2010	GB	3012588	5/2003
CN	201030148645.2		12/2010	GB	3012808	5/2003
CN	201030161835.8		12/2010	GB	3019145	10/2004
CN	201030171836.0		12/2010	GB	3019841	12/2004
CN	201030181917.9		12/2010	GB	3019843	12/2004
CN	201030214528.1		12/2010	GB	4004335	9/2007
CN	201030237622.9		12/2010	GB	4007053	7/2008
CN	201030267482.X		1/2011	GB	4017133	9/2010
CN	201030289358.3		1/2011	HU	90459	9/2004
CN	201030516390.0		4/2011	JP	1030505	1/1999
CN	201030560294.6		4/2011	JP	1076857	7/2000
CN	201030560327.7		4/2011	JP	1084122	9/2000
CN	201030633995.8		5/2011	JP	1102519	3/2001
CN	201030680263.4		5/2011	JP	1103647 S	3/2001
CN	201030200021.0		6/2011	JP	1108509 S	5/2001
CN	201030702441.9		6/2011	JP	1111977 S	6/2001
CN	201130002156.0		6/2011	JP	1131029 S	1/2002
CN	201130340079.X		9/2011	JP	1231223 S	2/2005
CN	201030690438.x		10/2011	JP	1237631 S	4/2005
CN	201130218453.9		11/2011	JP	1276267 S	7/2006
CN	201130257952.9		1/2012	JP	1276969 S	7/2006
CN	201130269639.7		2/2012	JP	1336425 S	7/2008
CN	201130269784.5		2/2012	JP	1336427 S	7/2008
CN	201130416451.0		2/2012	JP	1338148 S	8/2008
CN	201130270189.3		3/2012	JP	1338150 S	8/2008
CN	201130331821.0		3/2012	JP	1341590 S	10/2008
CN	201130340336.X		3/2012	JP	1342675 S	10/2008
CN	201130359306.3		3/2012	JP	1342858 S	10/2008
CN	201130376816.1		5/2012	JP	1352499 S	3/2009
CN	201130384353.3		5/2012	JP	1353747 S	3/2009
CN	201130407139.5		5/2012	JP	1353748 S	3/2009
CN	201130494499.3		5/2012	JP	1357458 S	4/2009
CN	201130414364.1		6/2012	JP	1361822 S	6/2009
CN	201130414365.6		6/2012	JP	1377434 S	1/2010
CN	201130435595.0		6/2012	JP	1379002 S	2/2010
CN	201130496329.9		6/2012	JP	1395044 S	8/2010
CN	201130400425.9		7/2012	JP	1395045 S	8/2010
CN	201130420669.3		7/2012	JP	1404693 S	1/2011
CN	201130475470.0		7/2012	JP	1404694 S	1/2011
CN	201130494692.7		7/2012	JP	1410911 S	4/2011
CN	201230001436.4		7/2012	JP	1443689 S	6/2012
DE	405043670016		3/2006	KR	3020040015550	4/2005
DK	200500295		1/2006	NL	76290	8/2003
EM	0005733570003		9/2006	NL	76897	12/2003
EM	0006030300001		12/2006	WO	DM046795	5/1999
EM	0007215760041		6/2007	WO	DM048251	8/1999
EM	0007926270003		2/2008	WO	DM049453	12/1999
EM	0007926270004		2/2008	WO	DM051604	7/2000
EM	0007926270006		2/2008	WO	DM053087	11/2000
EM	0007926350006		2/2008	WO	DM066445	8/2005
EM	0009105340001		4/2008	WO	DM066604	9/2005
EM	0008989370004		9/2008	WO	DM068047	9/2006
EM	0008143550001		5/2009	WO	WO2007045834 A2	4/2007
EM	0008143550002		5/2009	WO	WO2007045835 A2	4/2007
EM	0008143550003		5/2009	WO	DM068305	5/2007
EM	0009048000002		10/2009	WO	DM069628	7/2008

WO	DM072137	3/2010
WO	DM073314	4/2010
WO	DM073467	2/2011
WO	DM074266	2/2011
WO	DM075381	8/2011
WO	DM075729	9/2011

OTHER PUBLICATIONS

Blenko Glass Company product page for a vase #4703-HA [online] [retrieved on Mar. 29, 2013], 1 page. Retrieved from <<http://shop.blenko.com/4703-Floor-Vase-4703.htm>>.

Museum of Modern Art web page of a Martin Freeman (American) Vase (1949) [online] [retrieved on Mar. 29, 2013], 1 page. Retrieved from <[http://www.moma.org/collection/object.php?object\\_id=3881](http://www.moma.org/collection/object.php?object_id=3881)>.

Cincinnati Art Museum web page of a Louis Comfort Tiffany Vase, Accession No. 1897.131, 1982-1986 [online] [retrieved on Mar. 29, 2013], 1 page. Retrieved from <<http://www.cincinnatiartmuseum.org/explore/collection/collections/?u=6030118>>.

Amazon.com web page of a Dartington Crystal Curve Oval Vase [online] [Retrieved on Mar. 29, 2013], 1 page. Retrieved from [http://www.amazon.com/Dartington-Crystal-Curve-Oval Vase/dp/B000KEIM88](http://www.amazon.com/Dartington-Crystal-Curve-Oval-Vase/dp/B000KEIM88)>.

Kosta Boda product page of a Kosta Boda Orchid vase [online] [retrieved on Mar. 29, 2013], 1 page. Retrieved from <[http://www.moma.org/collection/object.php?object\\_id=3881](http://www.moma.org/collection/object.php?object_id=3881)>.

The Art Institute of Chicago web page of a vase [online] [retrieved on Mar. 29, 2013], 1 page. Retrieved from <<http://www.artic.edu/aic/collections/artwork/143586/print>>.

Mimosa product page of an LSA International Milano Vase [online] [retrieved on Mar. 29, 2013], 1 page. Retrieved from <[http://www.mimosawares.com/products/style\\_studio/vases\\_%2526\\_bowls/Isa\\_milano\\_32cm\\_vase\\_cased\\_black/](http://www.mimosawares.com/products/style_studio/vases_%2526_bowls/Isa_milano_32cm_vase_cased_black/)>.

WholeSalemart product page of a Duo Tone Modern Vase [online] [retrieved on Mar. 29, 2013], 1 page. Retrieved from <<http://www.wholesalemart.com/Wholesale-Duo-Tone-Modern-Vase-p/38377.htm>>.

beau coup product page of a pastel favor vase [online] [retrieved on Mar. 29, 2013], 1 page. Retrieved from <<http://www.beau-coup.com/pastelfavorvase.htm>>.

Replacements, Ltd. product page of a Nambe Flame Vase [online] [retrieved on Mar. 29, 2013], 1 page. Retrieved from <<http://www.replacements.com/webquote/NAMFLAM.htm?s1=GPLA&2551093&productTargetID=44782483134&gclid=CND1vd7pobYCFfA-Mgod5xYAnQ>>.

[online] [retrieved on Jun. 21, 2010] Retrieved from <http://72.249.182.183/collection/results.do?id=7678&db=object&view=detail>, Cincinnati Art Museum, Accession No. 1952.322, Vase, Edward George Diers, 1900.

\* cited by examiner

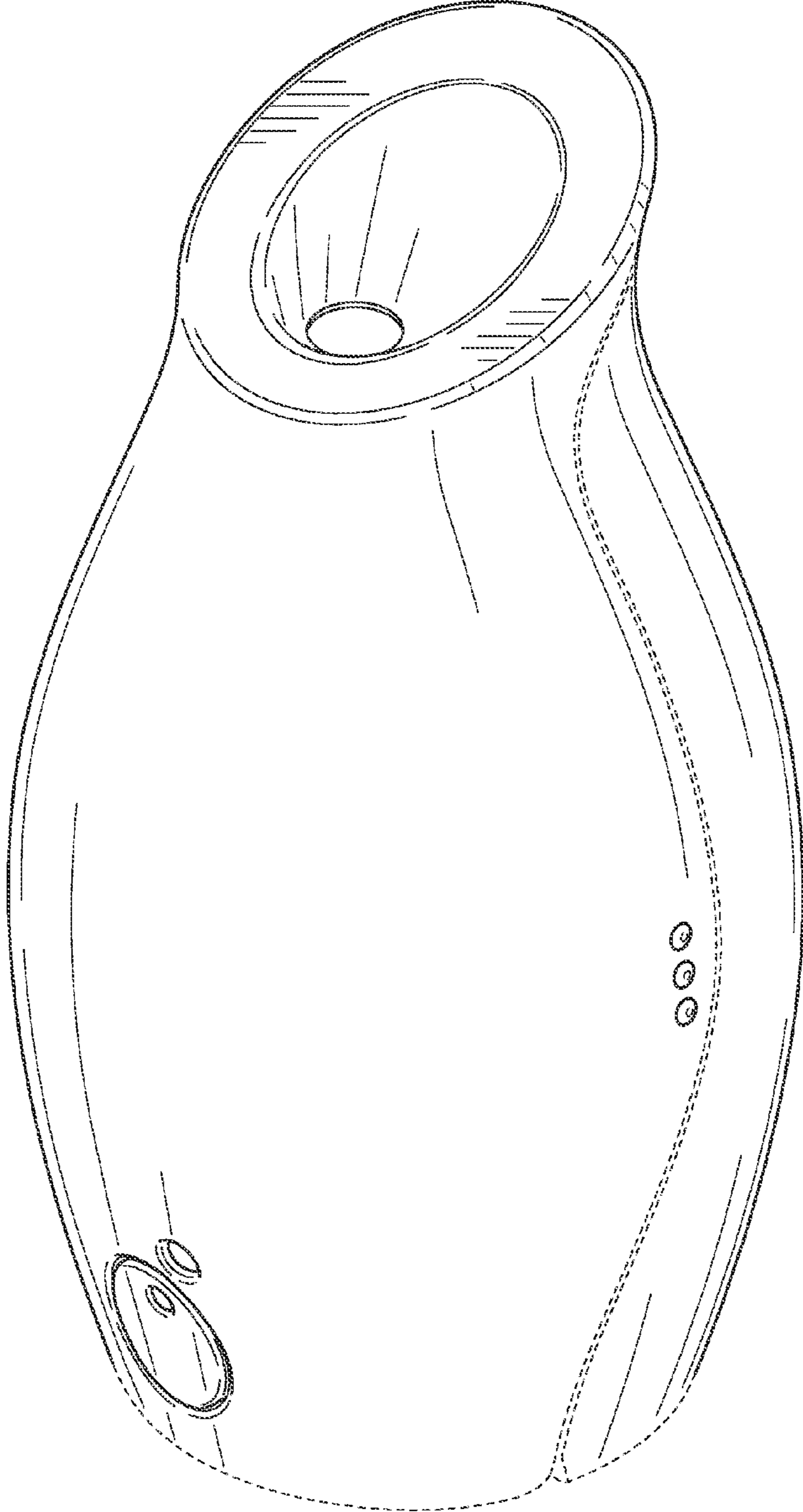

FIG. 1

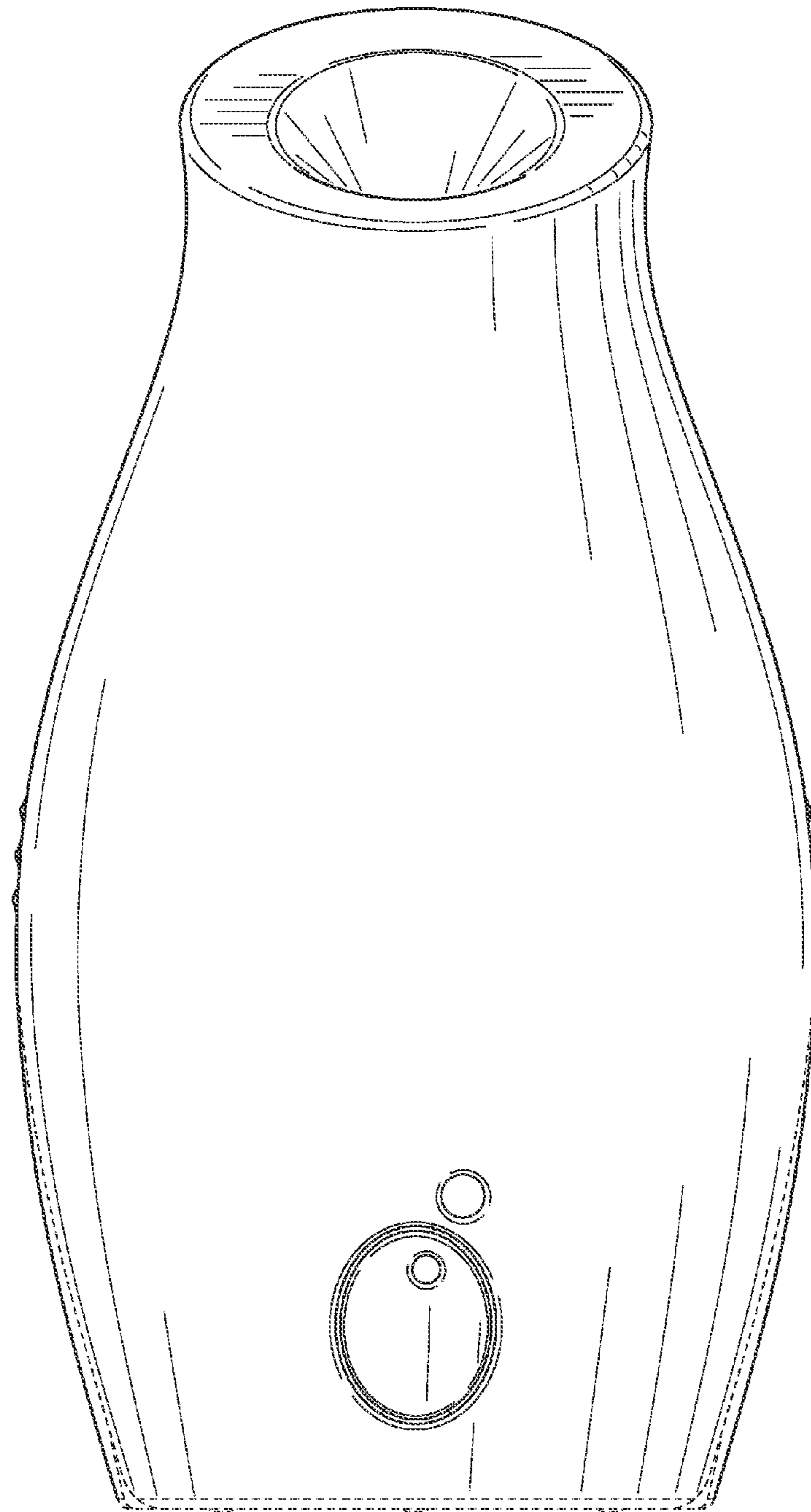

FIG. 2

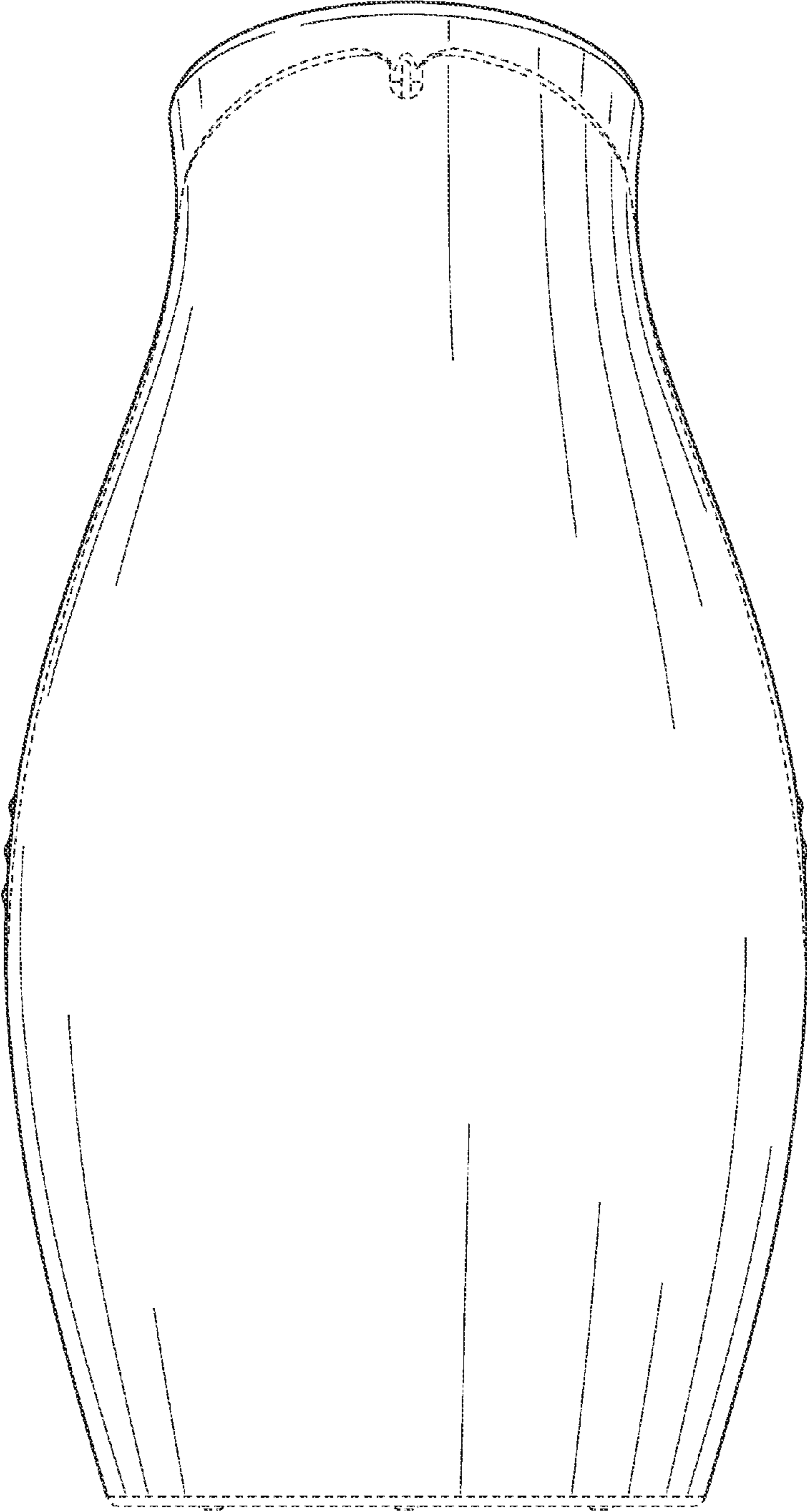

FIG. 3

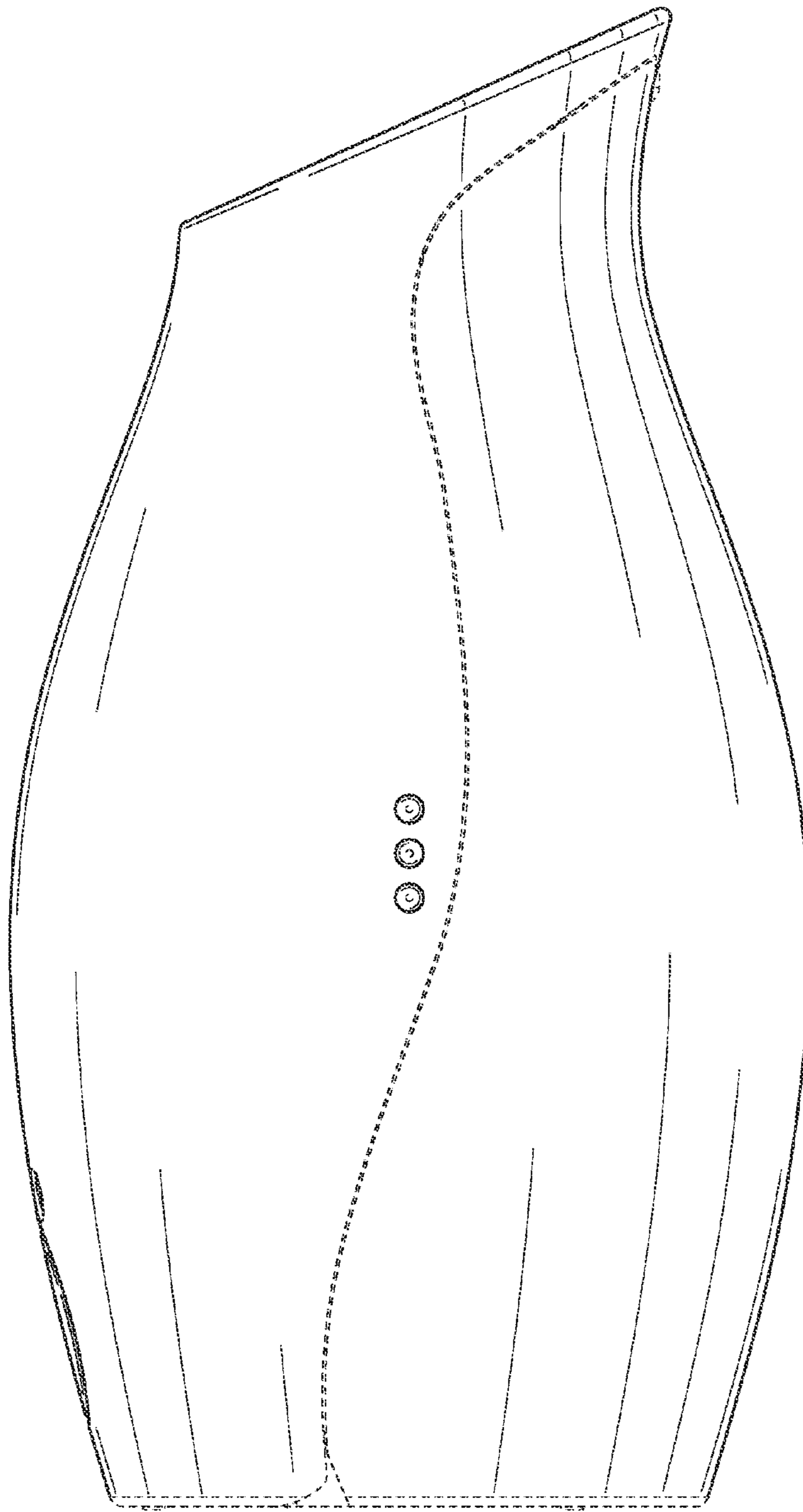

FIG. 4



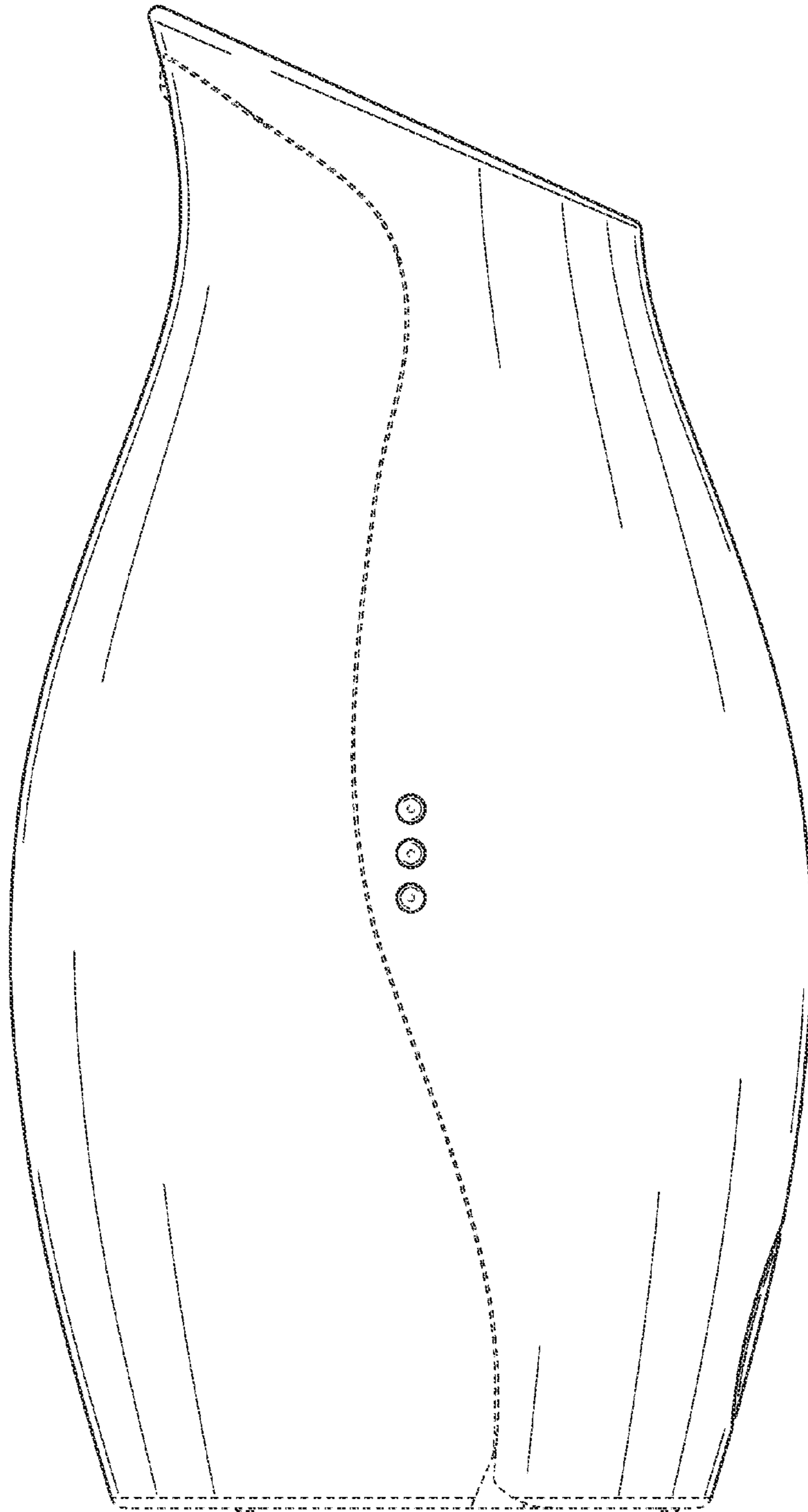

FIG. 5

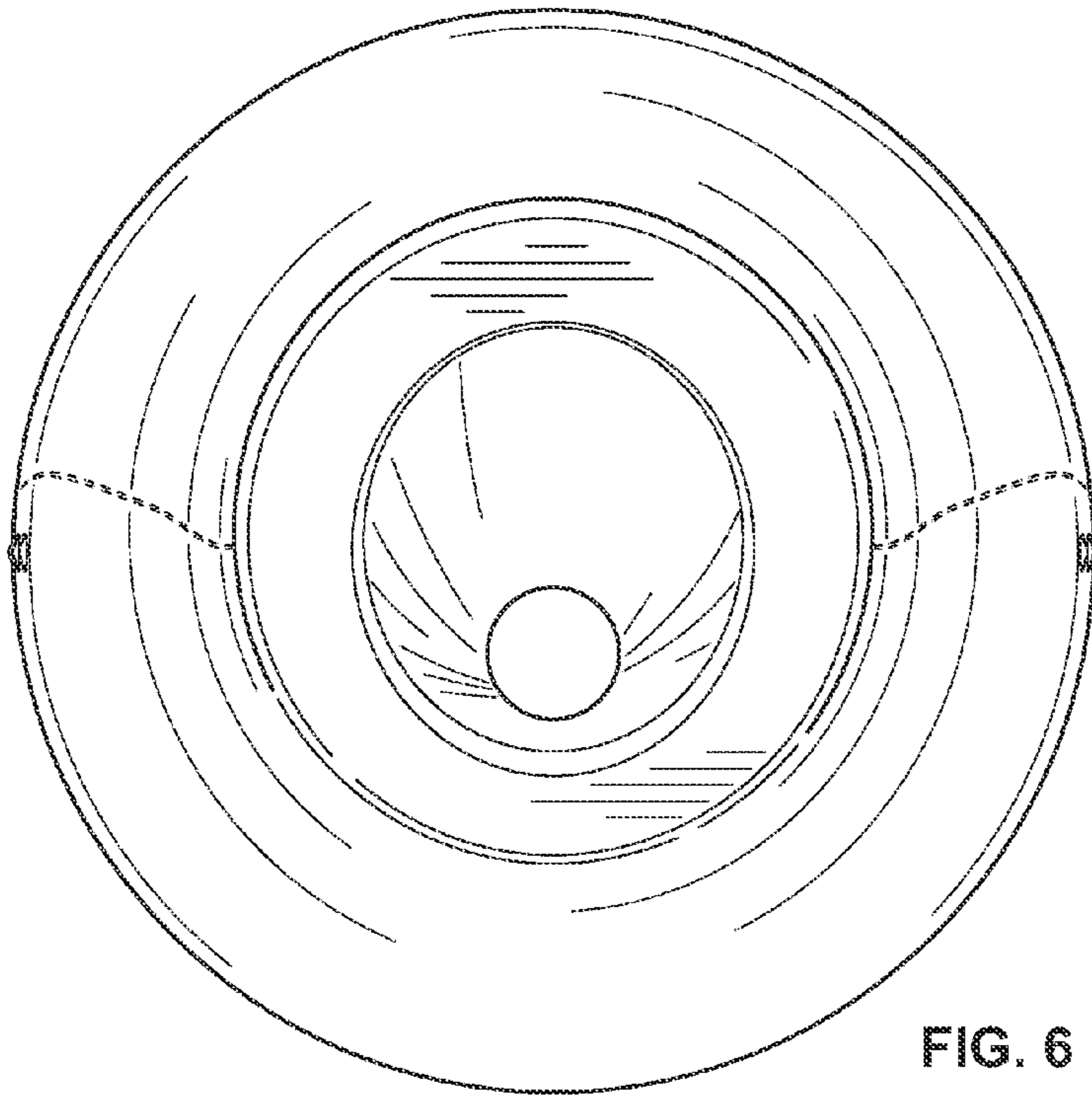

FIG. 6

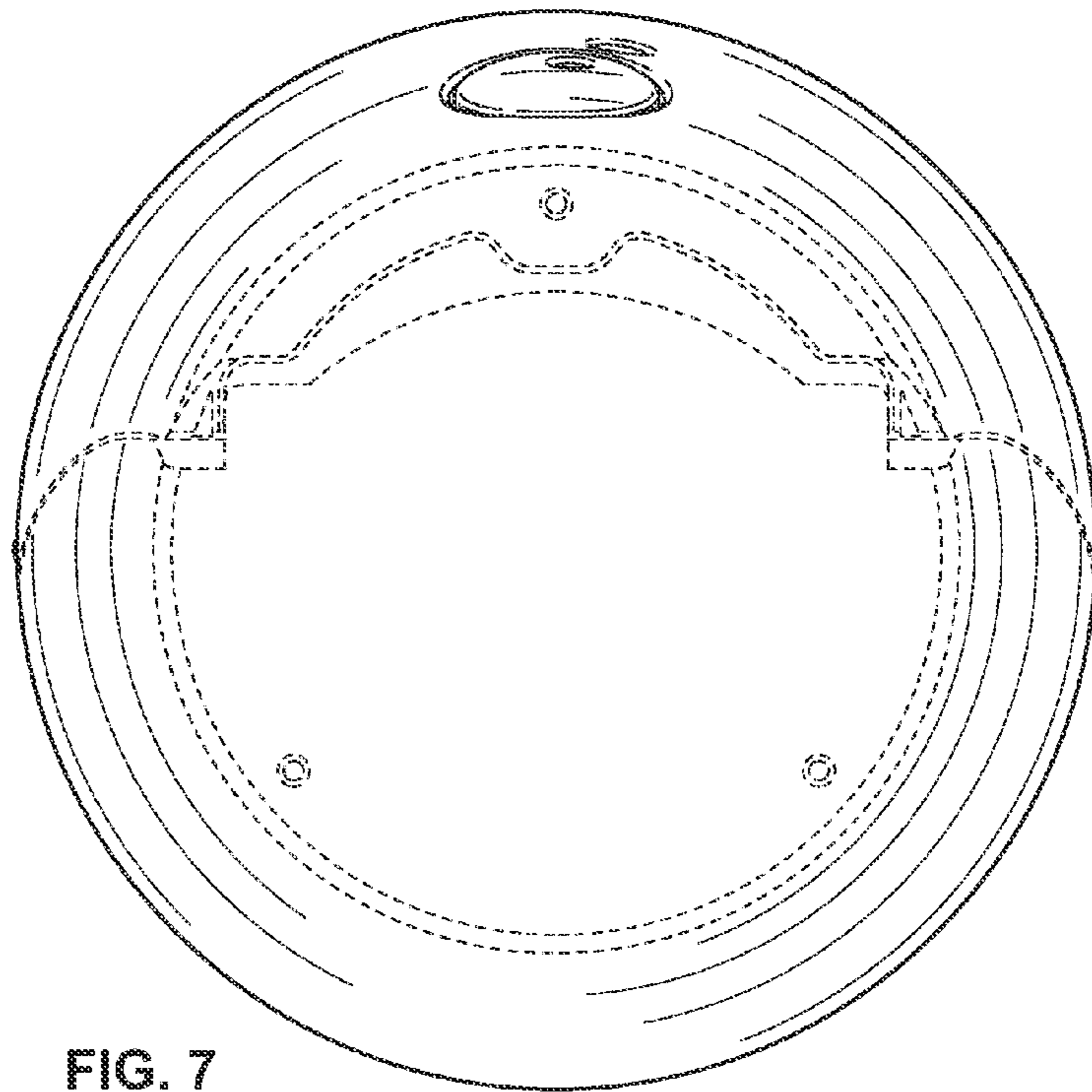

FIG. 7