



US00D689994S

(12) **United States Design Patent**
Jun et al.

(10) **Patent No.:** **US D689,994 S**

(45) **Date of Patent:** **** Sep. 17, 2013**

(54) **AIR CONDITIONER**

Primary Examiner — Brian N Vinson

(75) Inventors: **Young-Joong Jun**, Seoul (KR);
Sanghoon Yoon, Seoul (KR)

(74) *Attorney, Agent, or Firm* — Ladas & Parry LLP

(73) Assignee: **Samsung Electronics Co., Ltd.**,
Suwon-Si (KR)

(57) **CLAIM**

The ornamental design for an air conditioner, as shown and described.

(**) Term: **14 Years**

(21) Appl. No.: **29/426,724**

DESCRIPTION

(22) Filed: **Jul. 10, 2012**

(51) **LOC (9) Cl.** **23-04**

(52) **U.S. Cl.**
USPC **D23/351**

(58) **Field of Classification Search**
USPC D23/314, 317, 332–333, 351; 312/236;
62/259.1, 259.3, 259.4, 262–263, 304, 401,
62/515–516; 454/330–331, 349–350, 354
See application file for complete search history.

FIG. 1 is a top, front, and right side perspective view of an air conditioner showing our new design;
FIG. 2 is a front elevational view thereof;
FIG. 3 is a rear elevational view thereof;
FIG. 4 is a left side elevational view thereof;
FIG. 5 is a right side elevational view thereof;
FIG. 6 is a top plan view thereof;
FIG. 7 is a bottom plan view thereof; and,
FIG. 8 is an additional front elevational view thereof with the broken-line disclosure of the vents in an open position being for illustrative purposes only and forming no part of the claimed design. The other broken-line disclosure in the views shows portions of the article which also form no part of the claimed design.

The broken-line disclosure in the views is understood to represent portions of the article in which the claimed design is embodied, but which form no part of the claimed design.

(56) **References Cited**

U.S. PATENT DOCUMENTS

D454,187 S *	3/2002	Wang et al.	D23/351
D508,118 S *	8/2005	Motonishi et al.	D23/351
D547,849 S *	7/2007	Francisquini	D23/351
D557,782 S *	12/2007	Choi	D23/351
D580,032 S *	11/2008	Kim et al.	D23/351
D649,234 S *	11/2011	Iovanel	D23/351

* cited by examiner

1 Claim, 7 Drawing Sheets

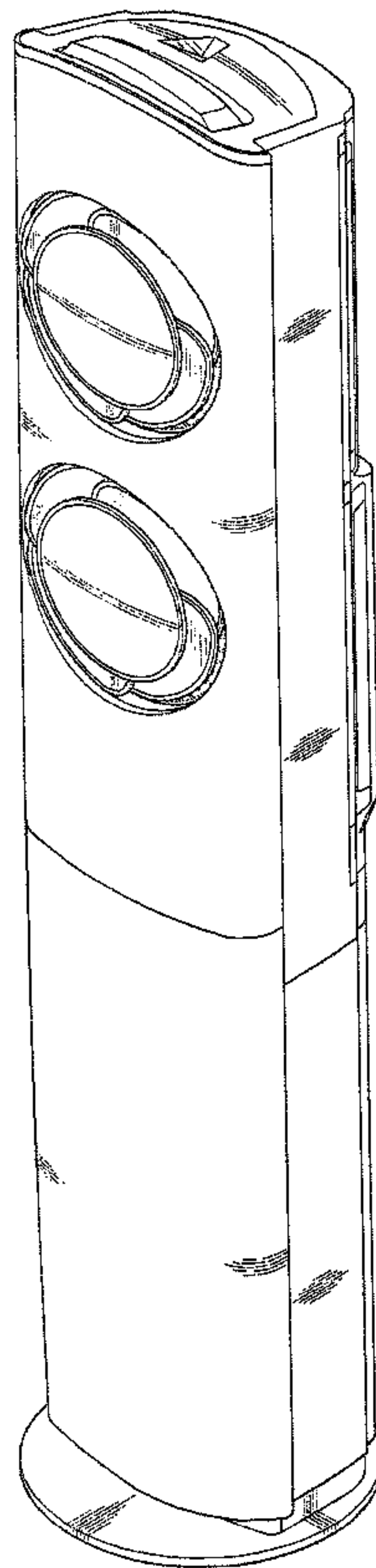

FIG. 1

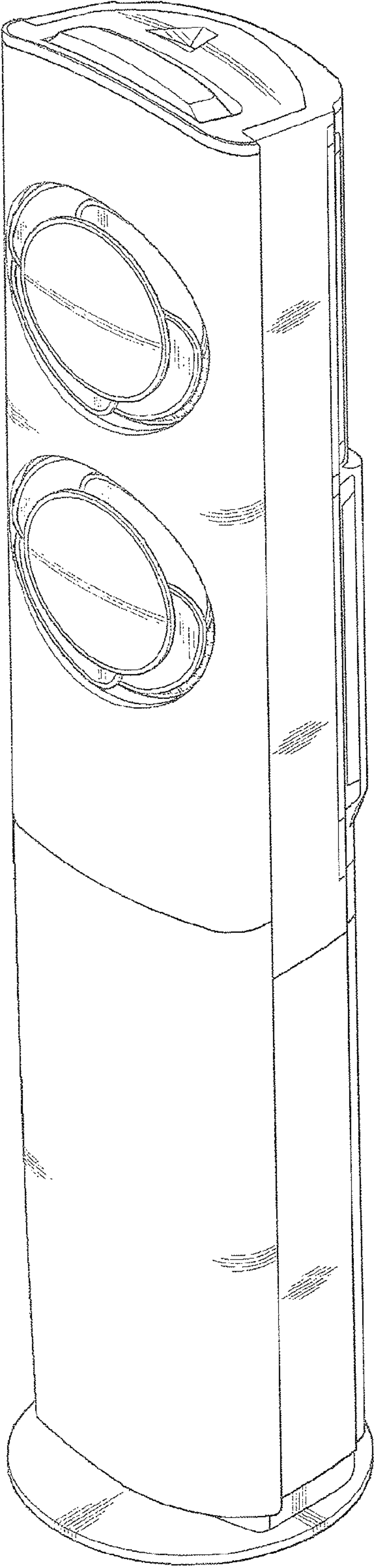

FIG. 2

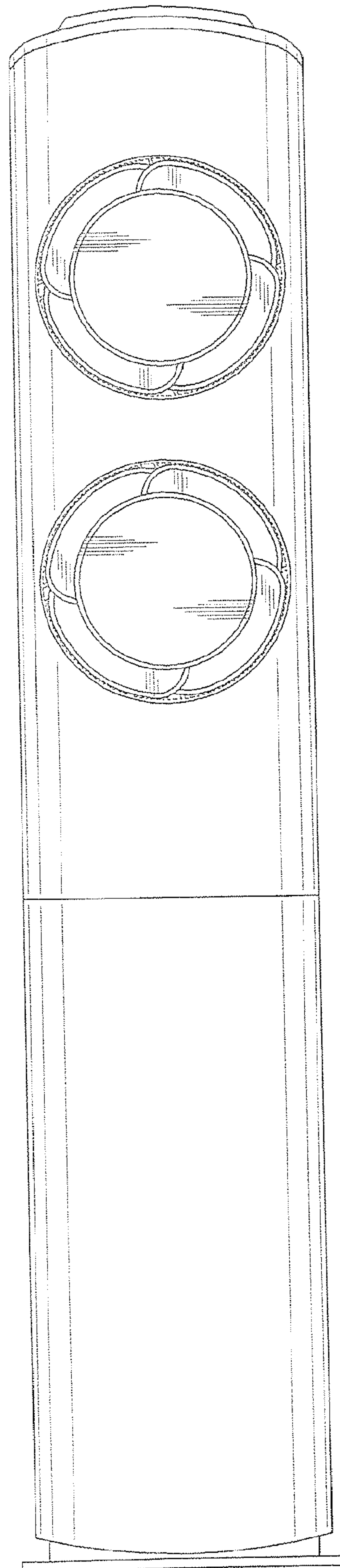

FIG. 3

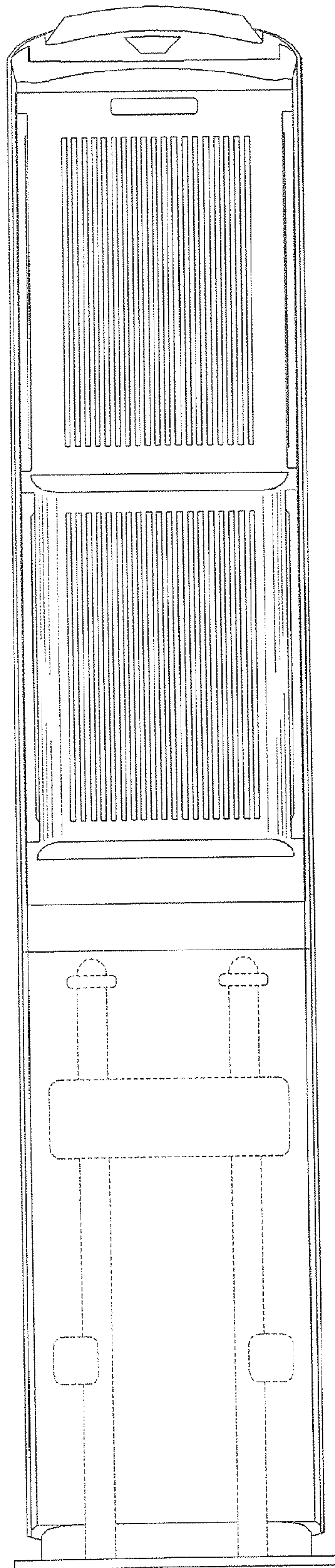

FIG. 4

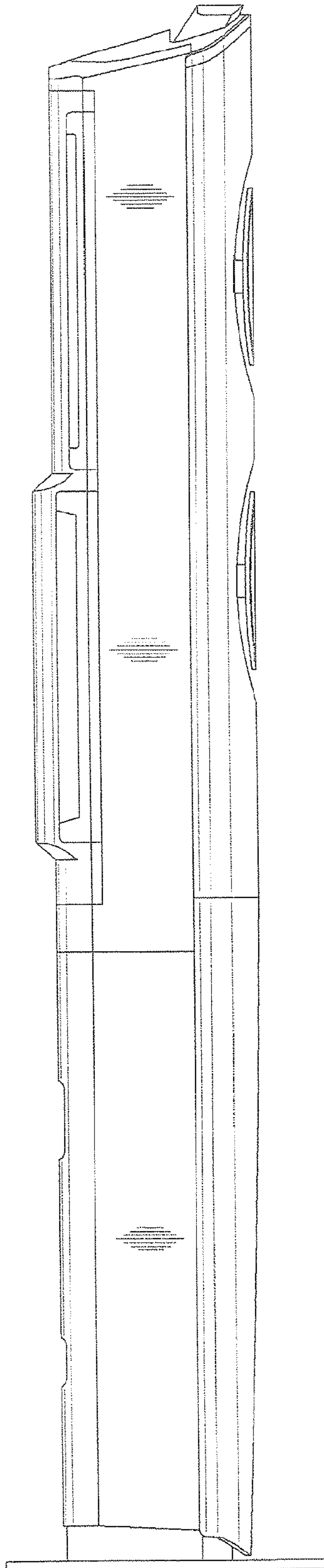

FIG. 5

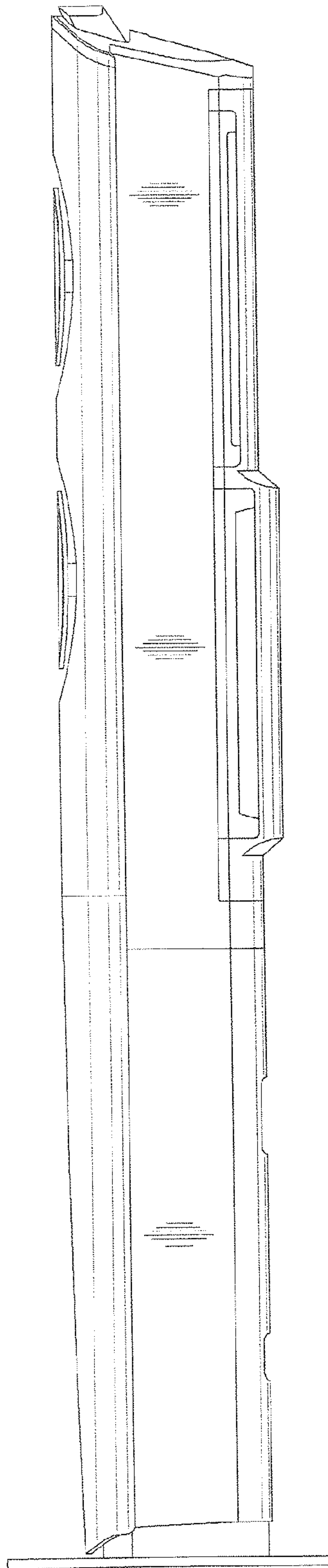

FIG. 6

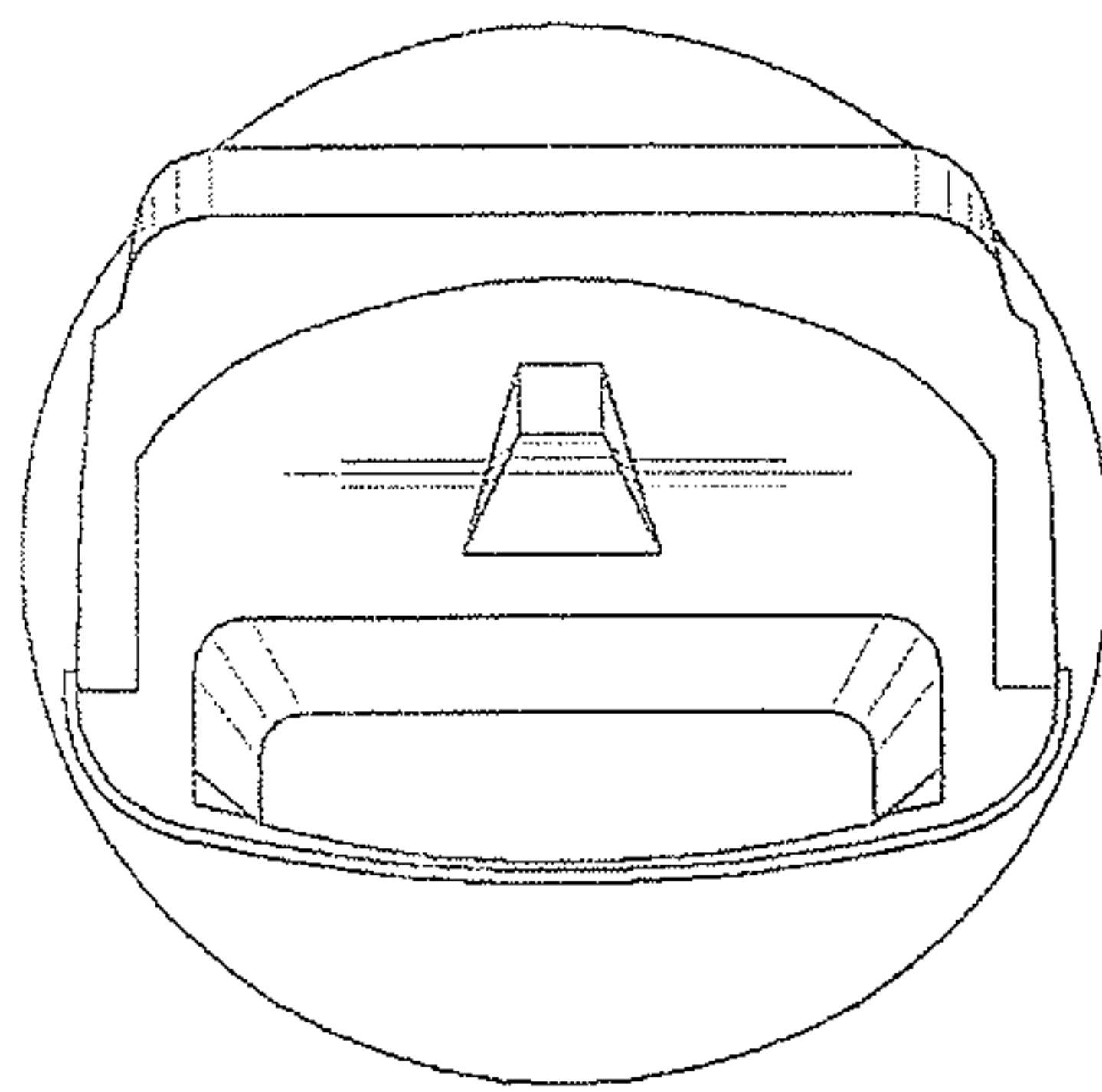

FIG. 7

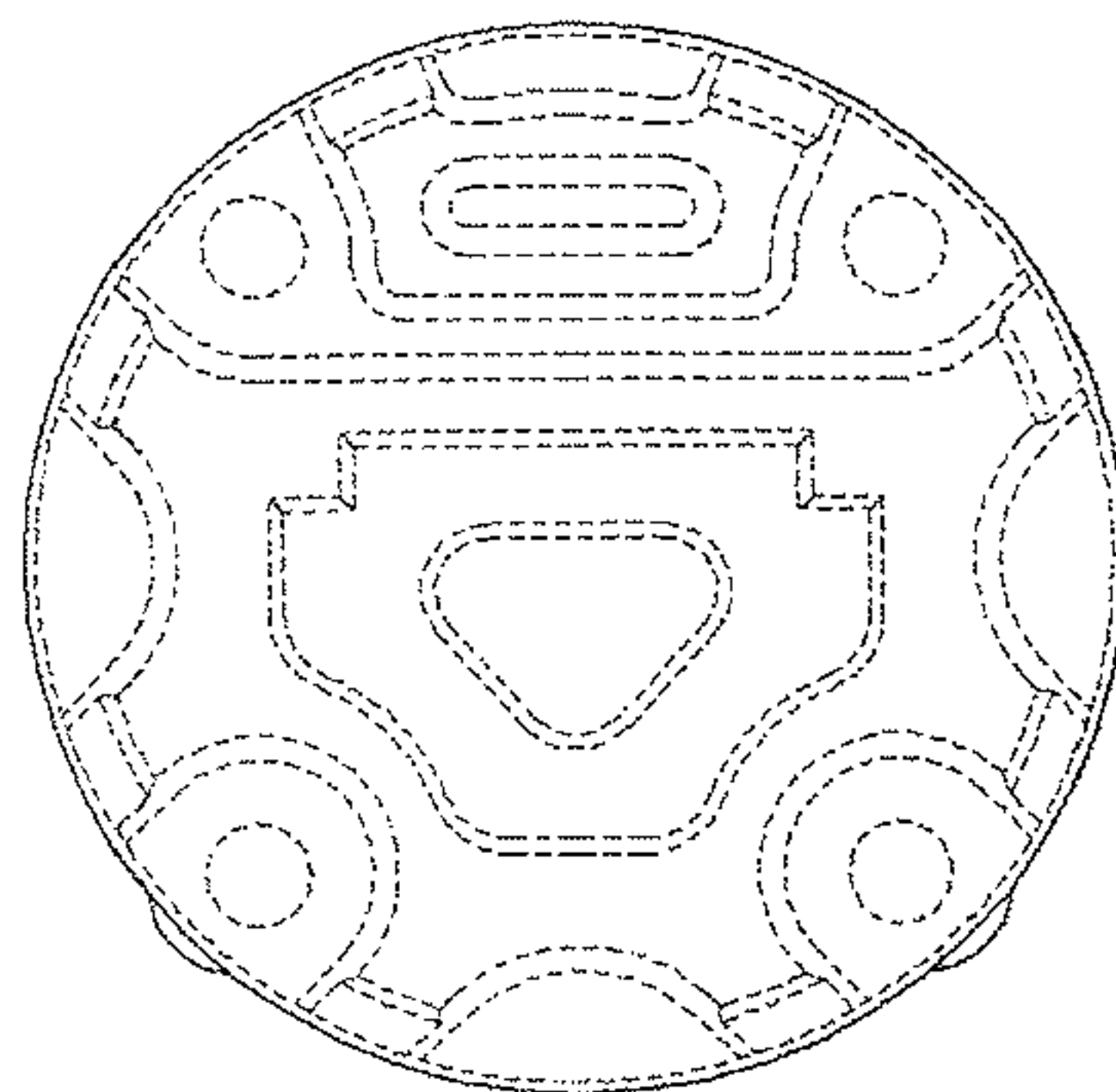

FIG. 8

