



US00D689943S

(12) **United States Design Patent**
Hu

(10) **Patent No.:** **US D689,943 S**

(45) **Date of Patent:** **** Sep. 17, 2013**

(54) **FILE ORGANIZER**

(75) Inventor: **Yajun Hu**, El Dorado Hills, CA (US)

(73) Assignee: **Designa Group Inc.**, El Dorado Hills, CA (US)

(**) Term: **14 Years**

(21) Appl. No.: **29/408,891**

(22) Filed: **Dec. 18, 2011**

(51) **LOC (9) Cl.** **19-02**

(52) **U.S. Cl.**
USPC **D19/90**

(58) **Field of Classification Search**
USPC D3/304, 306, 313, 314, 315; D6/675.2,
D6/683, 683.1, 705.6; D7/553.2, 553.3,
D7/553.6, 553.7, 554.2, 554.3; D19/75,
D19/77-92; 206/214, 425, 449, 558, 371;
220/485, 607;
211/10, 11, 45, 50, 55, 69.1-69.9, 126.1
See application file for complete search history.

D336,927 S	6/1993	Samuels et al.	
D359,404 S *	6/1995	Svee	D6/476
D383,633 S *	9/1997	Schweitzer	D6/567
D390,268 S *	2/1998	Stravitz	D19/90
5,803,275 A *	9/1998	Schweitzer	211/88.01
5,826,730 A *	10/1998	Stravitz	211/55
D433,712 S *	11/2000	Walsh	D19/90
D458,640 S *	6/2002	Hofman	D19/90
D488,511 S *	4/2004	Hardy	D19/90
D520,002 S	5/2006	Mello	
D523,245 S *	6/2006	Post	D3/306
D550,284 S	9/2007	Goodman et al.	
D555,736 S *	11/2007	Decarlo et al.	D19/90
D604,769 S	11/2009	Chen et al.	
7,921,998 B2	4/2011	Schenker	
D665,846 S	8/2012	Chuang	

* cited by examiner

Primary Examiner — Elizabeth Albert

(57) **CLAIM**

The ornamental design for a file organizer, as shown and described.

DESCRIPTION

FIG. 1 is a perspective view of file organizer showing my design.

FIG. 2 is a front view thereof;

FIG. 3 is a bottom view thereof;

FIG. 4 is a top view thereof;

FIG. 5 is a rear side view thereof;

FIG. 6 is a left side view thereof; and,

FIG. 7 is a right side view thereof.

1 Claim, 7 Drawing Sheets

(56) **References Cited**

U.S. PATENT DOCUMENTS

3,176,849 A *	4/1965	Peebles	211/50
4,006,827 A	2/1977	Riches	
4,538,739 A *	9/1985	Licari et al.	211/189
D299,657 S	1/1989	Hwang	
D322,002 S *	12/1991	Emery	D6/566
D323,854 S	2/1992	Evenson	
5,140,724 A	8/1992	Crisanti	
D330,047 S	10/1992	Evenson	

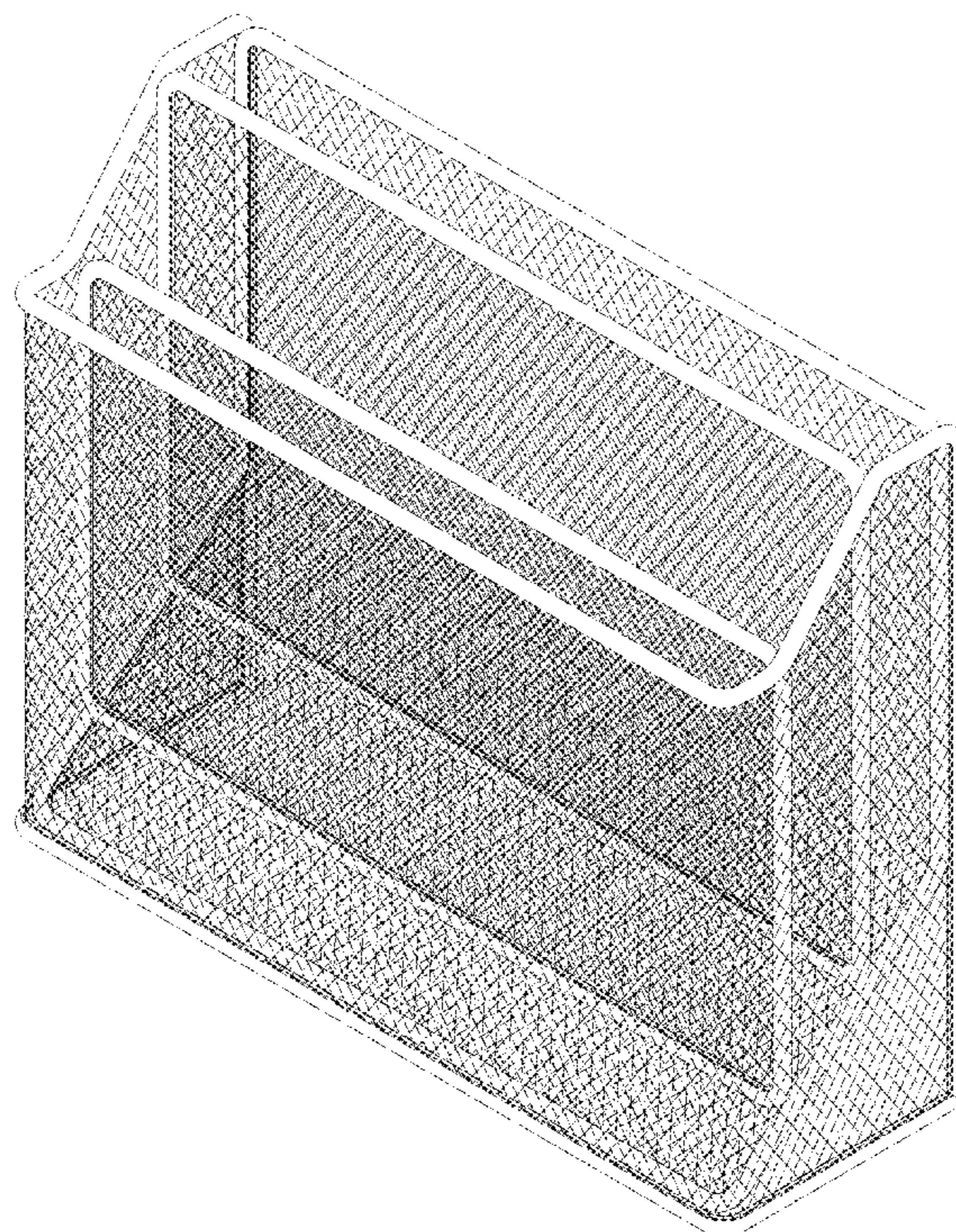

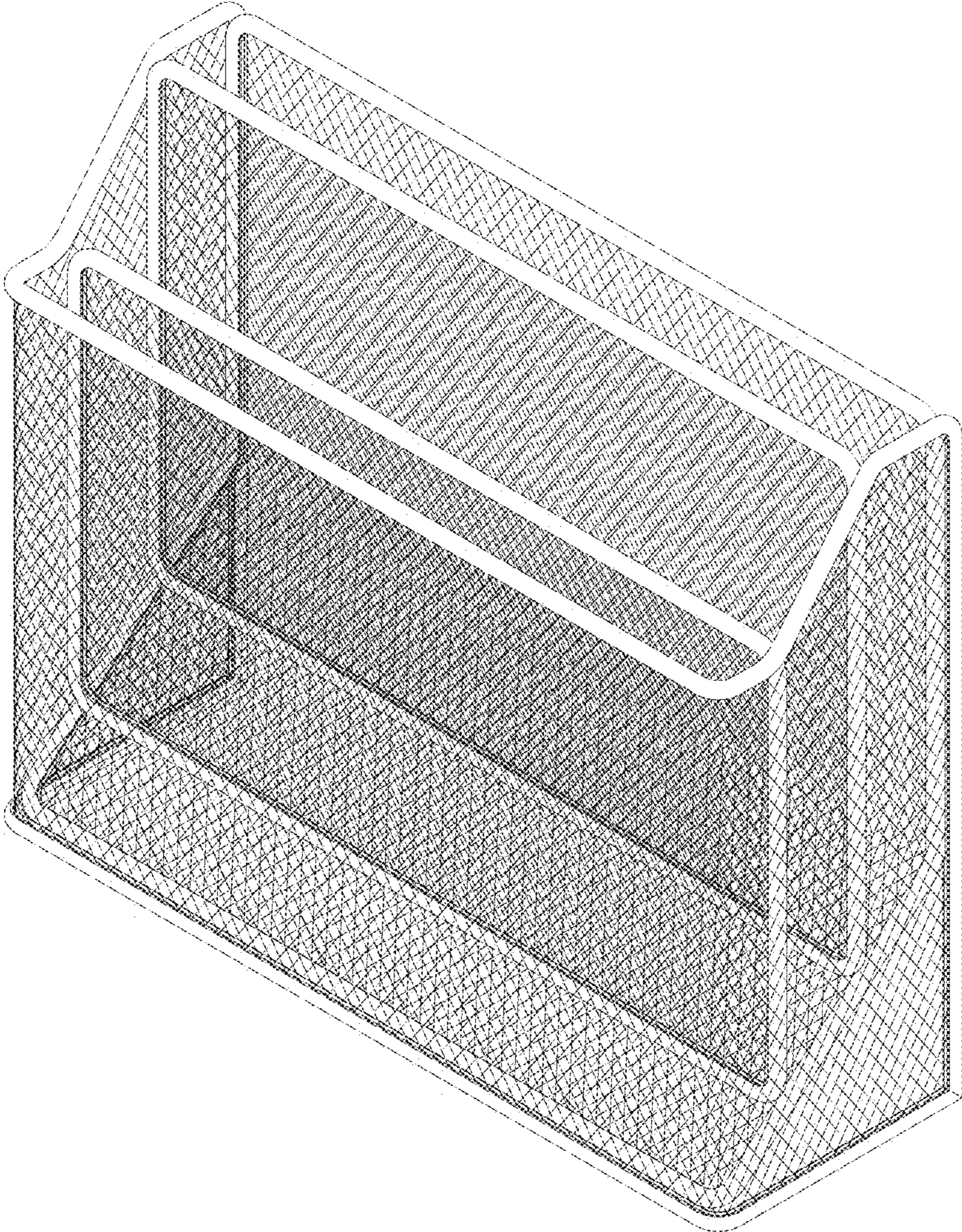

FIG.1

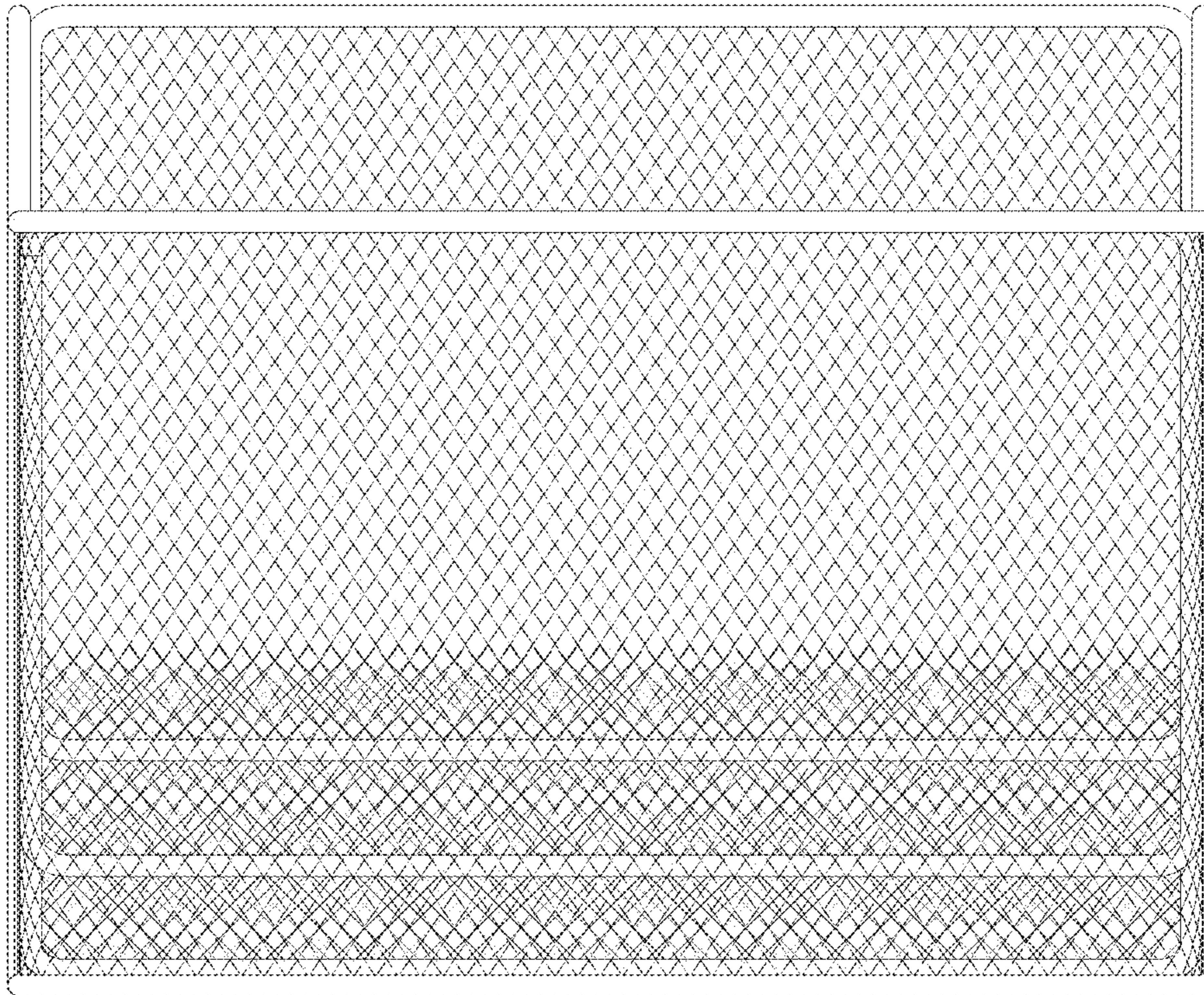

FIG.2

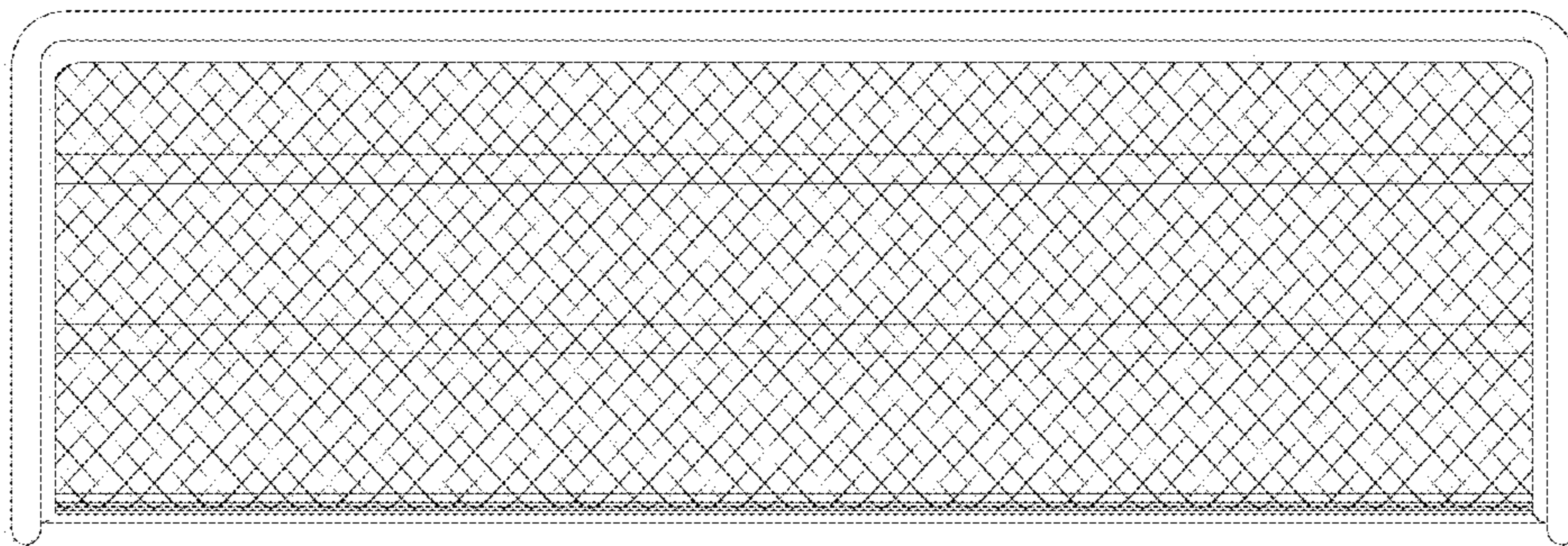

FIG.3

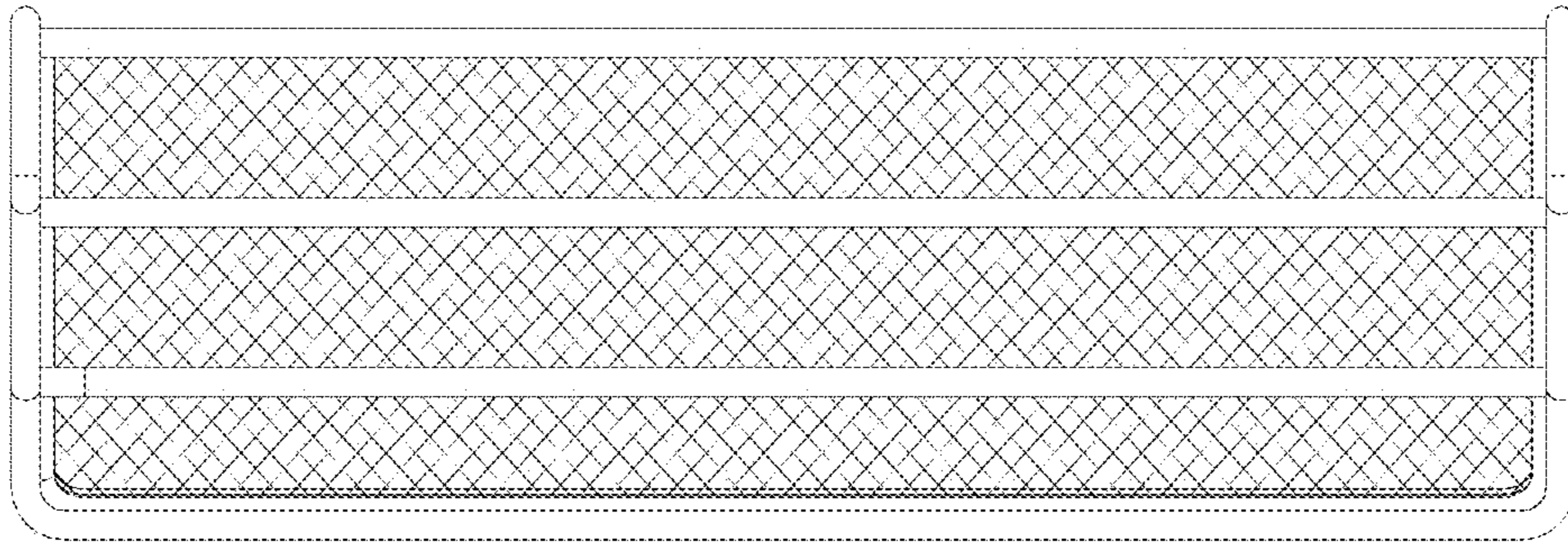

FIG.4

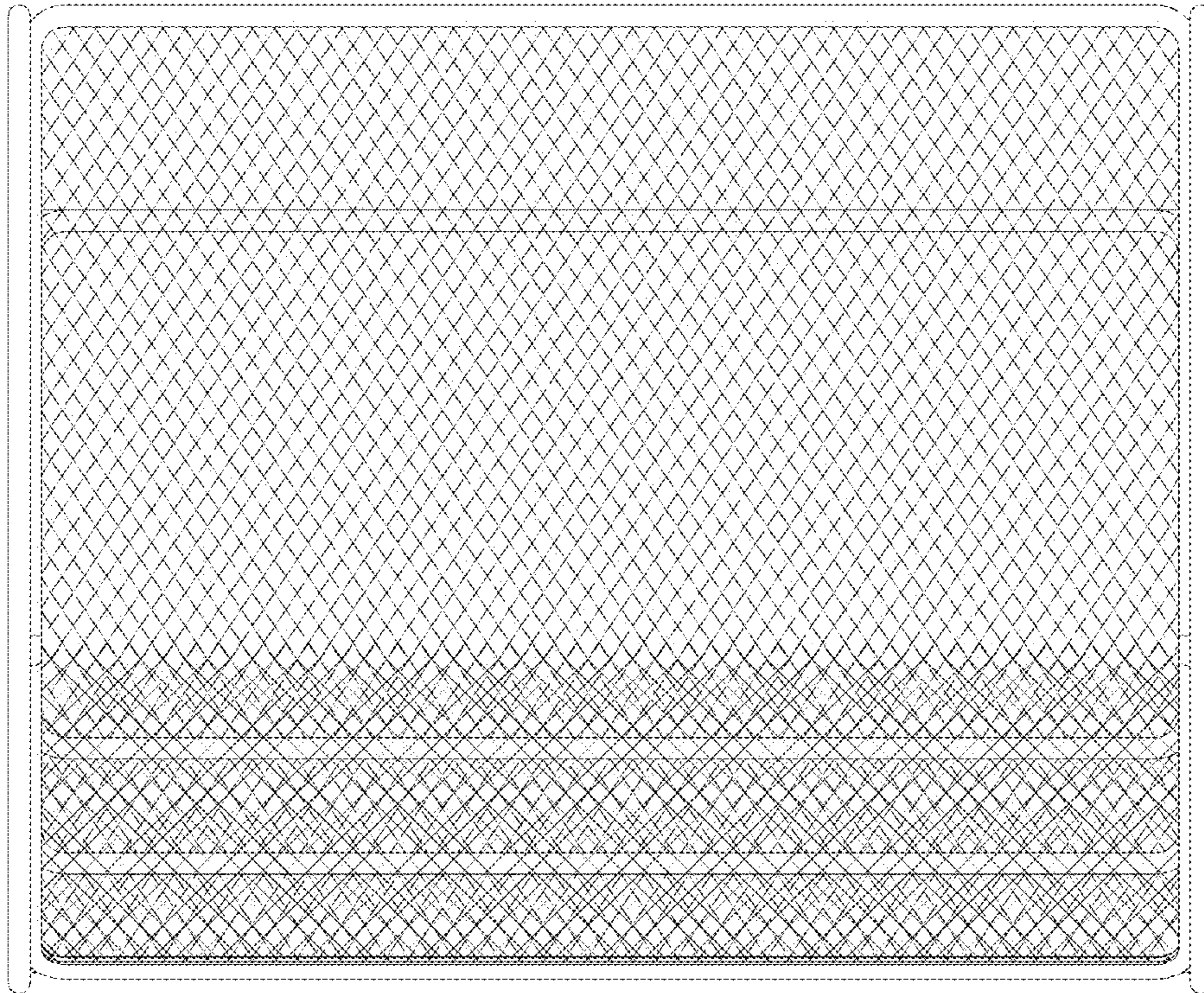

FIG. 5

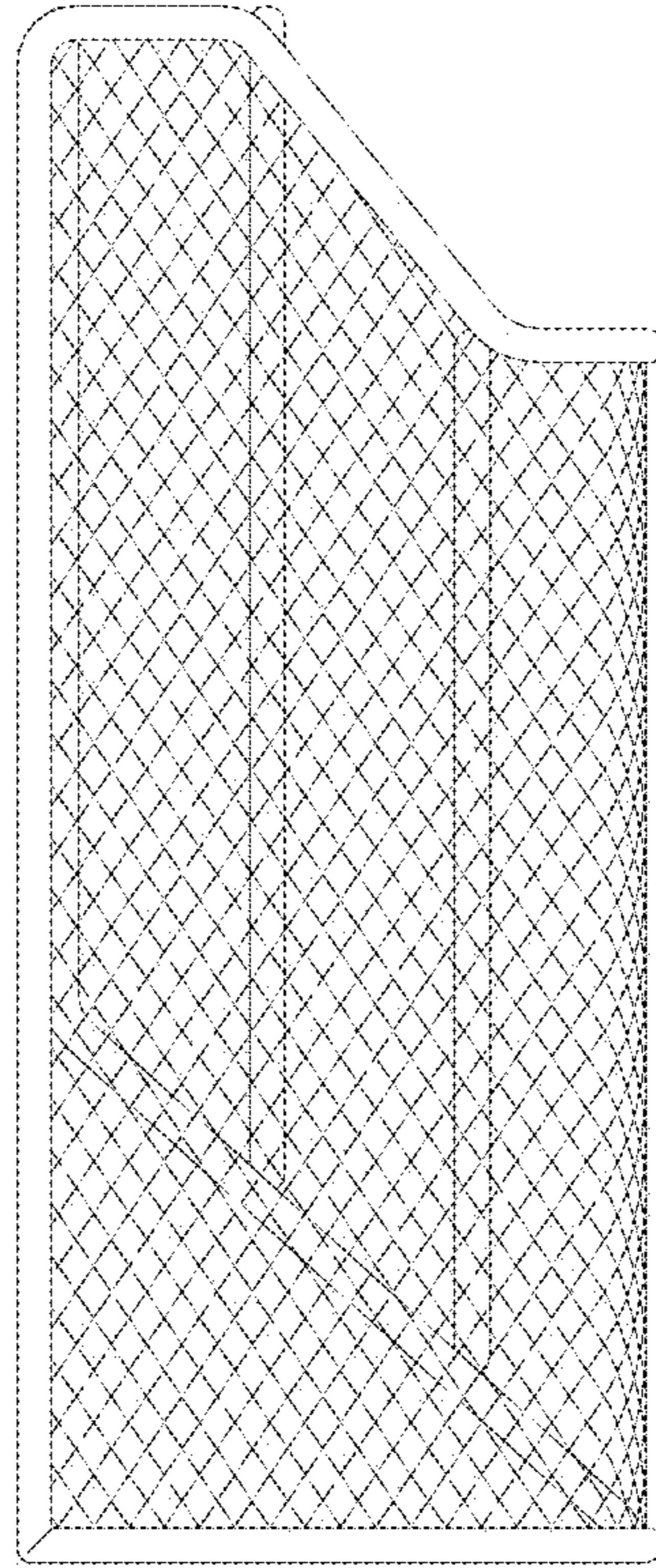

FIG.6

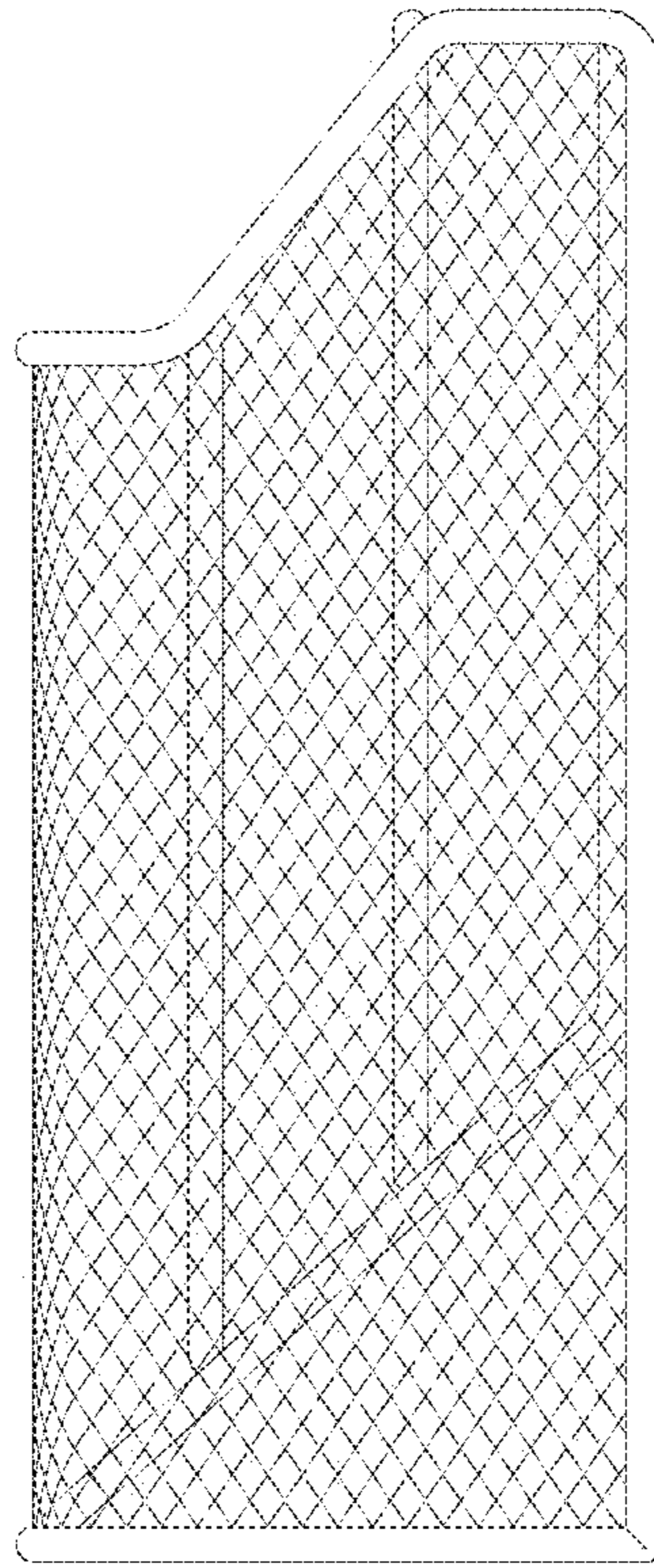

FIG.7