



US00D689844S

(12) **United States Design Patent**
Kiggen

(10) **Patent No.:** **US D689,844 S**

(45) **Date of Patent:** **** Sep. 17, 2013**

(54) **SOUND DOCK**

(75) Inventor: **Bert Kiggen**, Eindhoven (NL)

(73) Assignee: **D&M Europe B.V.**, Eindhoven (NL)

(**) Term: **14 Years**

(21) Appl. No.: **29/410,225**

(22) Filed: **Jan. 5, 2012**

(51) **LOC (9) Cl.** **14-01**

(52) **U.S. Cl.**
USPC **D14/209.1**

(58) **Field of Classification Search**
USPC D14/204, 207, 210-216, 172, 209.1;
181/143-144, 147-148, 150-153, 157, 198-199;
381/300-303, 306, 332-333, 336, 345, 361-364,
381/386-388

See application file for complete search history.

(56) **References Cited**

U.S. PATENT DOCUMENTS

7,095,867	B2 *	8/2006	Schul et al.	381/334
7,689,197	B2 *	3/2010	Laude et al.	455/344
D624,527	S *	9/2010	Ho et al.	D14/209.1
D639,272	S *	6/2011	Chow	D14/209.1
D639,273	S *	6/2011	Chow	D14/209.1

D644,626	S *	9/2011	Bolton	D14/209.1
D645,842	S *	9/2011	Bolton	D14/209.1
D647,502	S *	10/2011	Holzer	D14/171
8,063,292	B2 *	11/2011	Lin	84/386
D656,482	S *	3/2012	Colquhoun	D14/209.1
D661,686	S *	6/2012	Bolton	D14/209.1

* cited by examiner

Primary Examiner — Prabhakar Deshmukh

(74) *Attorney, Agent, or Firm* — McDonnell Boehnen Hulbert & Berghoff LLP

(57) **CLAIM**

The ornamental design for a sound dock, as shown and described.

DESCRIPTION

FIG. 1 is a front elevational view of a sound dock showing my new design;
FIG. 2 is a back elevational view thereof;
FIG. 3 is a left side elevational view thereof;
FIG. 4 is a right side elevational view thereof;
FIG. 5 is a top plan view thereof; and,
FIG. 6 is a bottom plan view thereof.

The broken lines shown in FIGS. 1 through 6 indicate disclaimed portions and form no part of the claimed design.

1 Claim, 6 Drawing Sheets

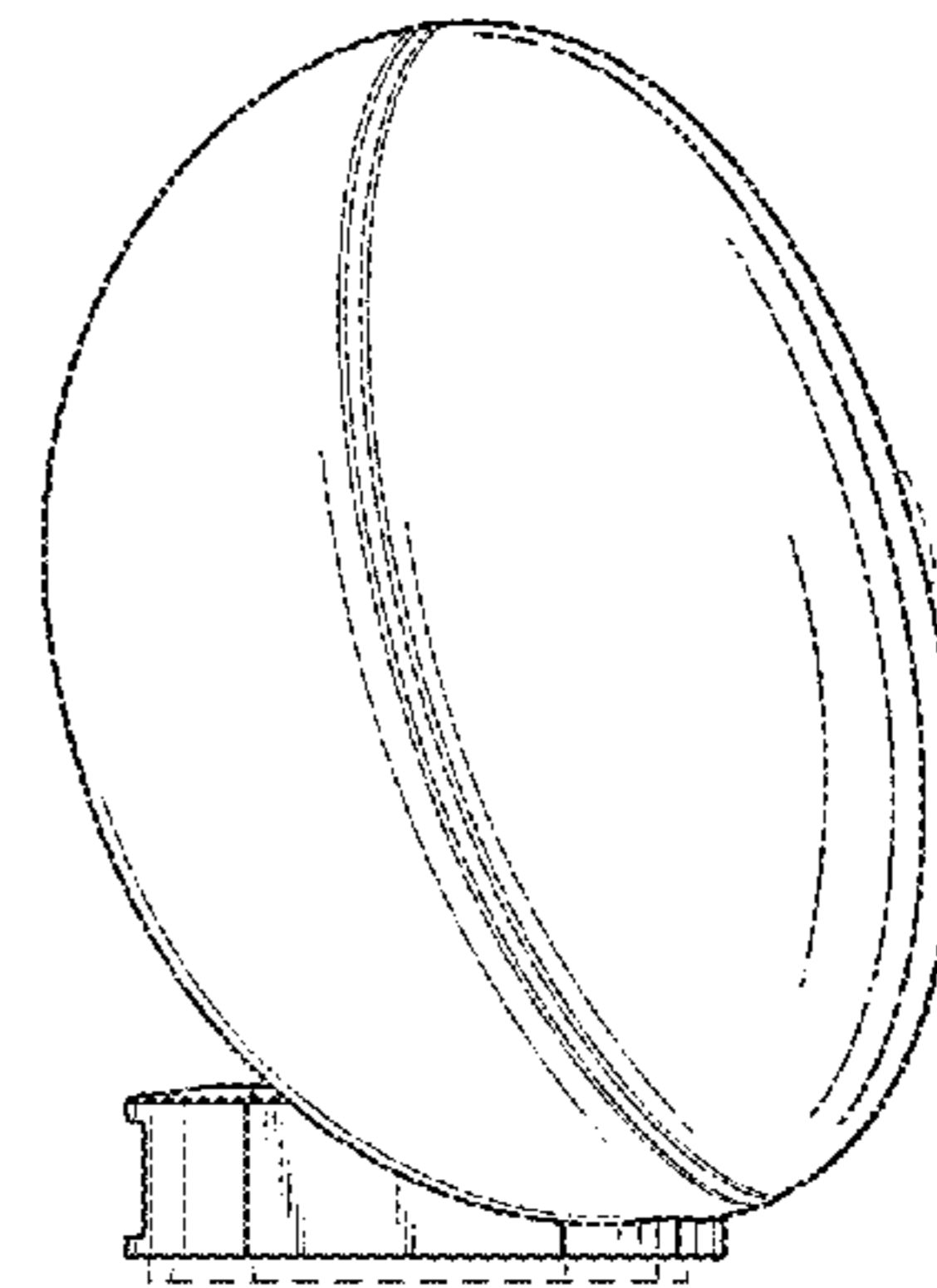
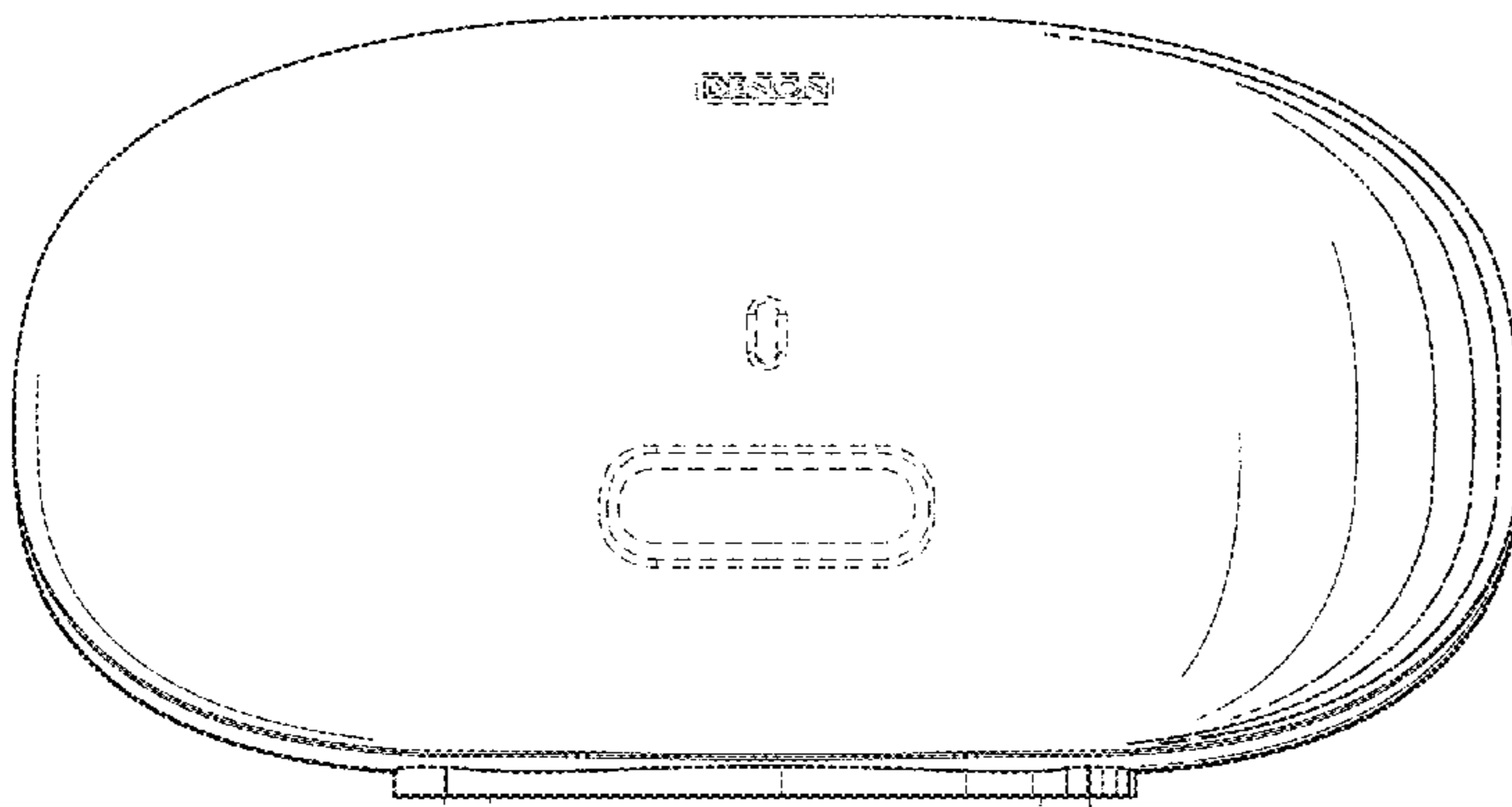

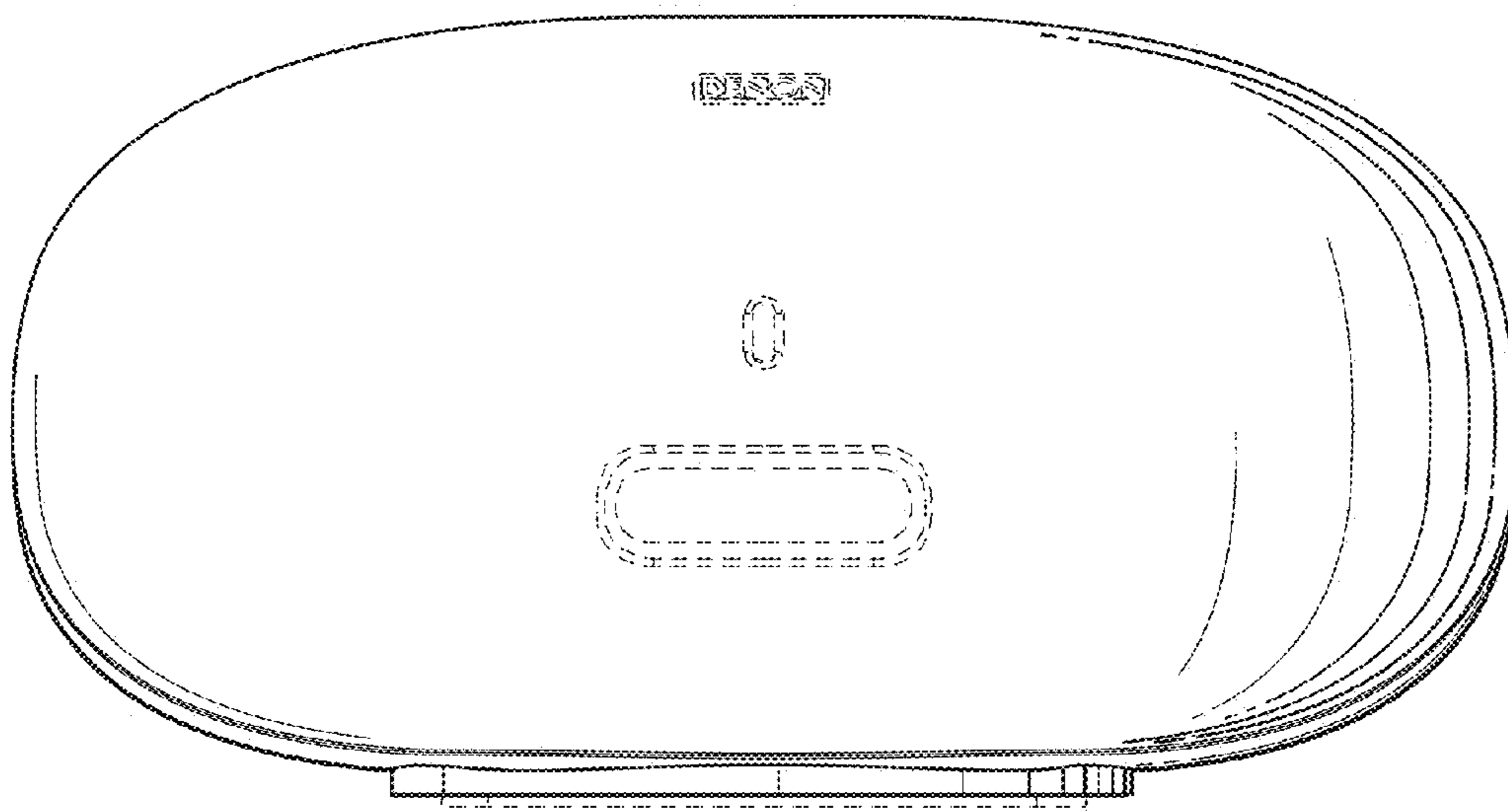

Figure 1

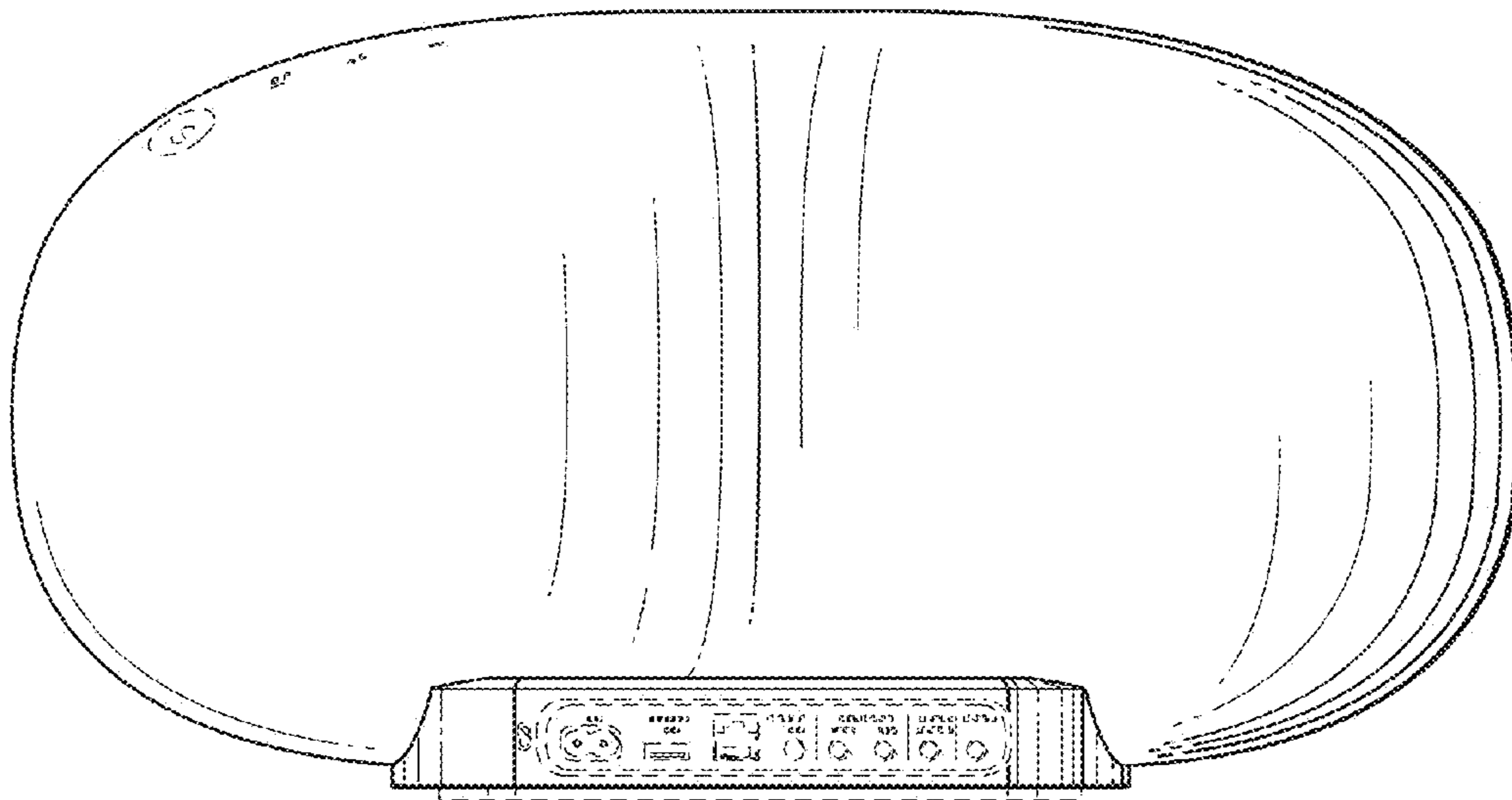

Figure 2

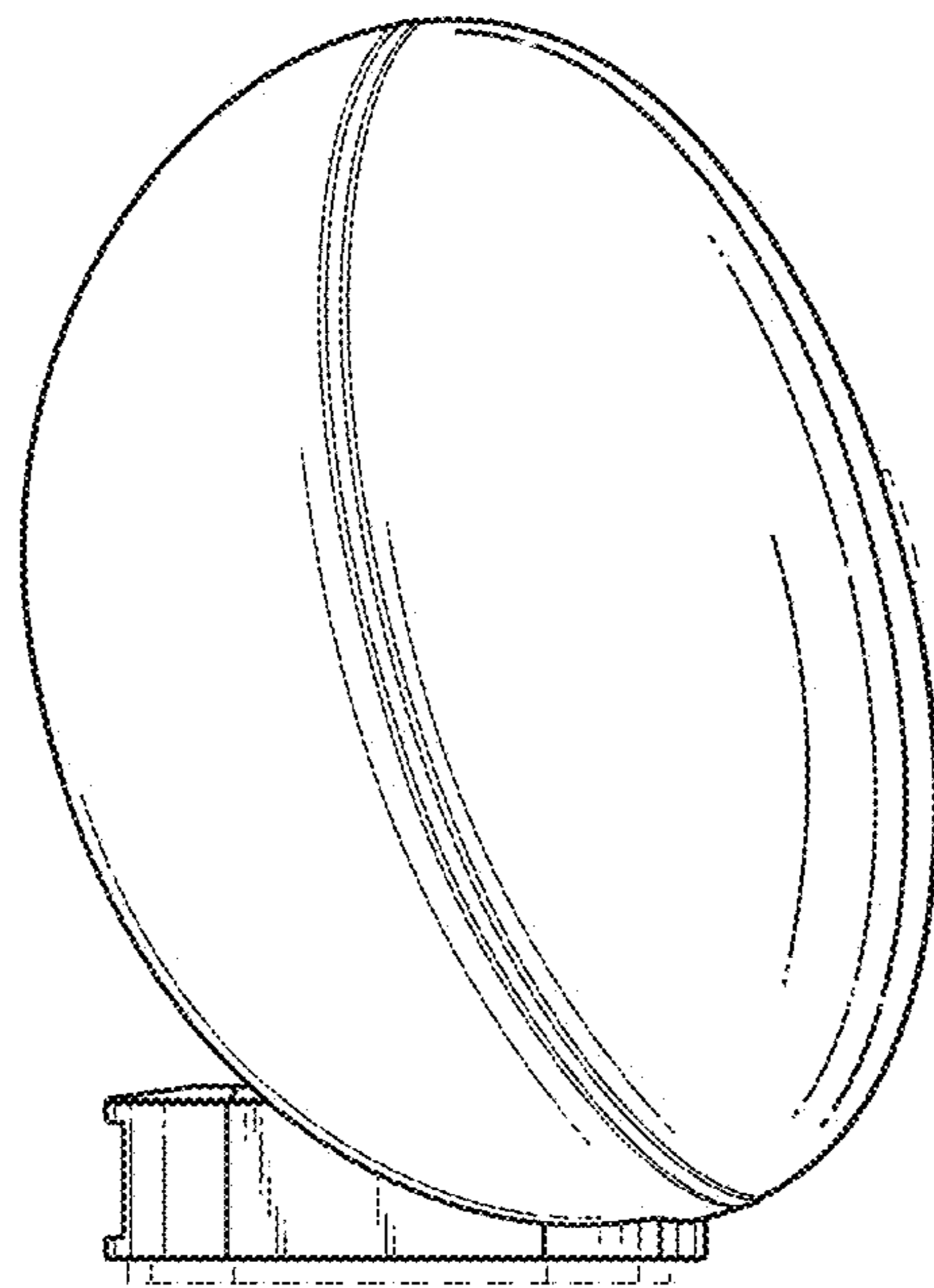

Figure 3

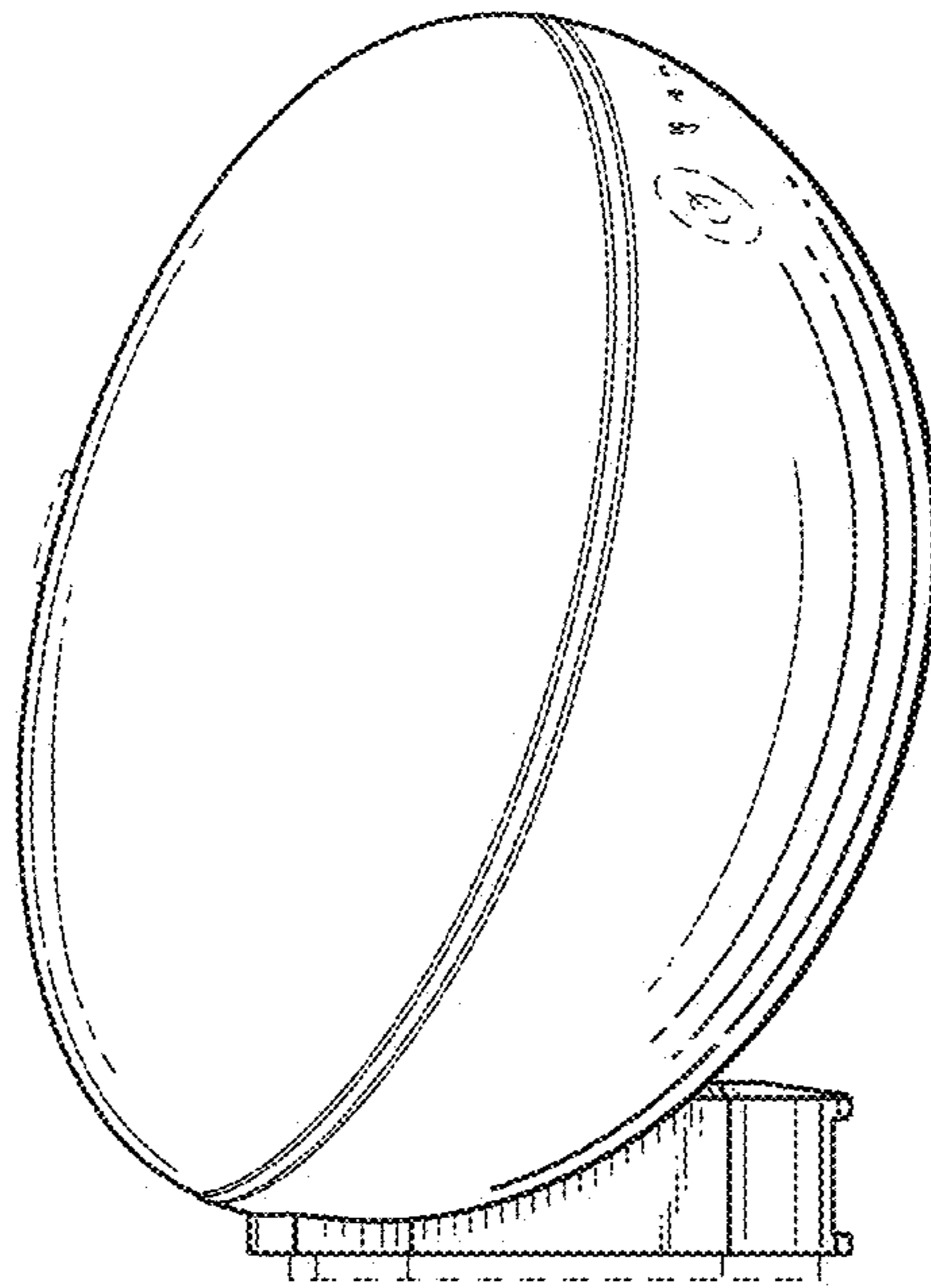

Figure 4

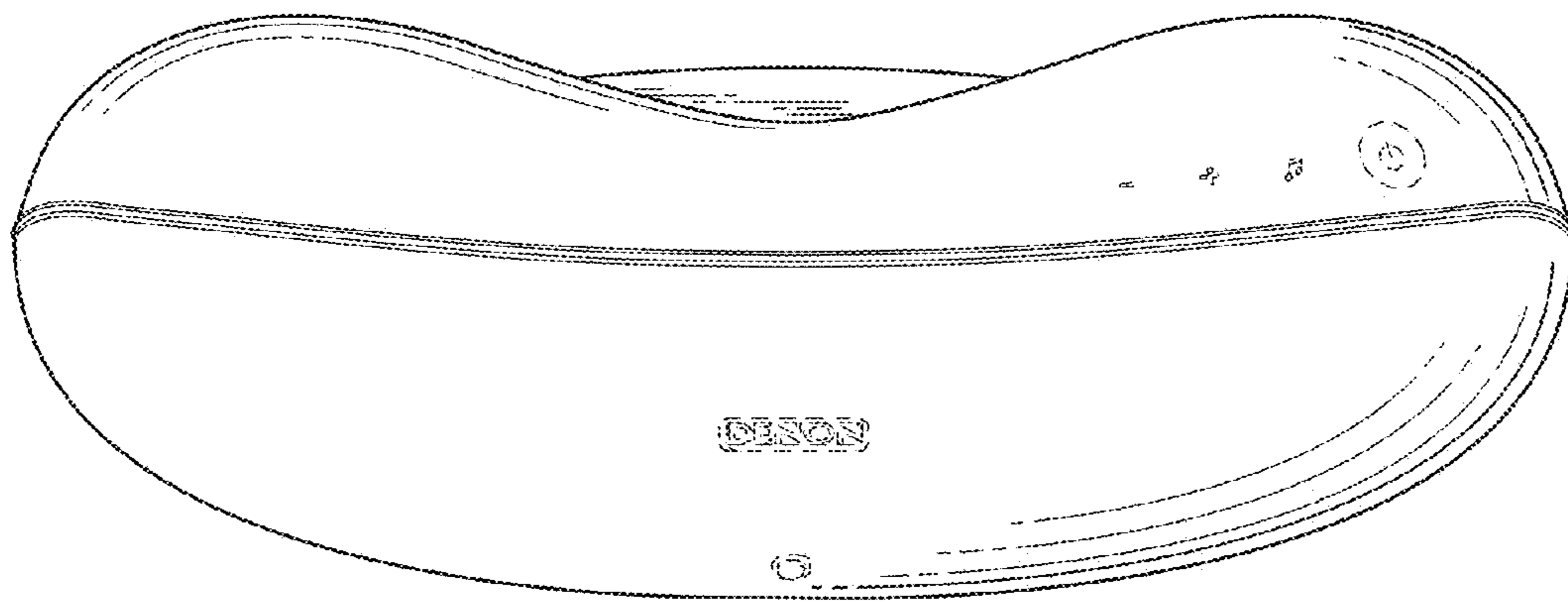

Figure 5

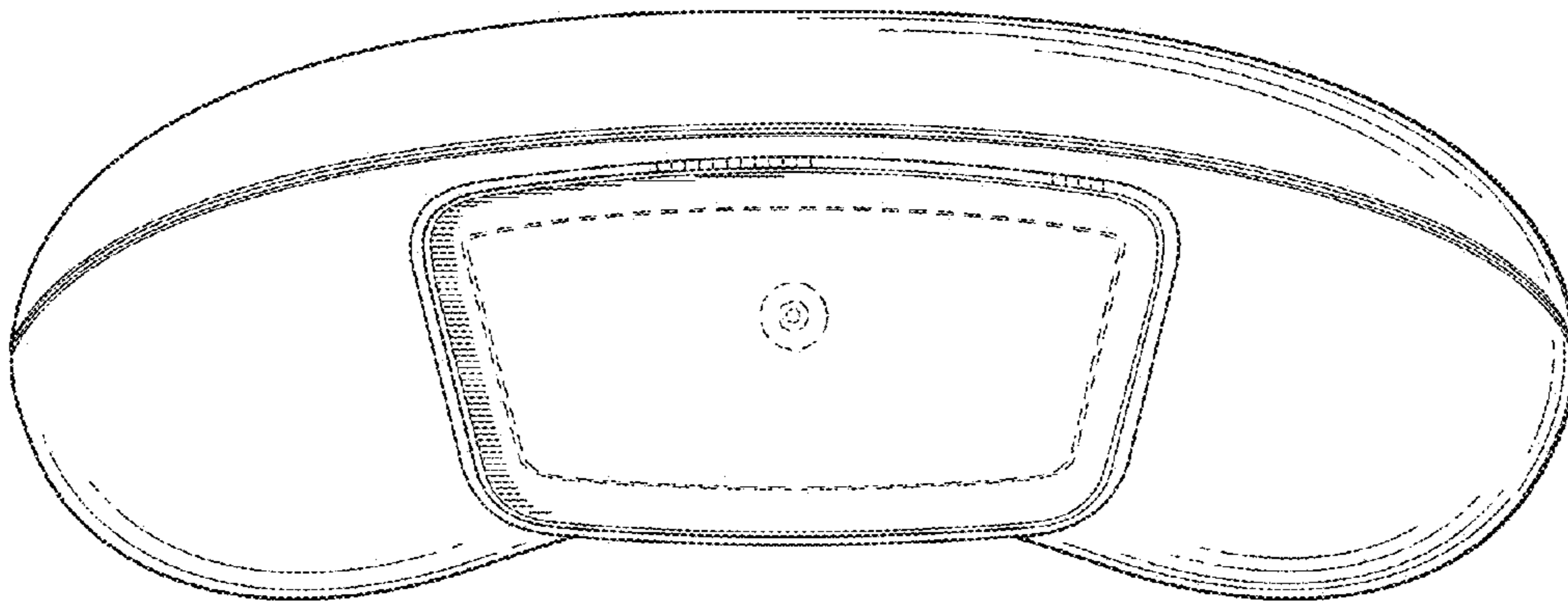

Figure 6